



# HelixNet<sup>®</sup>

## Partyline User Guide



## Document Reference

Clear-Com HelixNet Partyline User Guide

Part Number: 399G052 Revision: D

Legal Disclaimers

Copyright © 2014 HME Clear-Com Ltd.

All rights reserved.

Clear-Com, the Clear-Com logo, Clear-Com Concert and HelixNet are registered trademarks of HM Electronics, Inc.

The software described in this document is furnished under a license agreement and may be used only in accordance with the terms of the agreement.

The product described in this document is distributed under licenses restricting its use, copying, distribution, and decompilation/reverse engineering. No part of this document may be reproduced in any form by any means without prior written authorization of Clear-Com, an HME Company.

This product is covered by U.S. Patent Nos. 8,311,085 and 8,553,865 and by European Patent No. 2 176 987 B1.

Clear-Com Offices are located in California, USA; Cambridge, UK; Montreal, Canada; and Beijing, China. Specific addresses and contact information can be found on Clear-Com's corporate website:

[www.clearcom.com](http://www.clearcom.com)

Clear-Com Contacts

Americas and Asia-Pacific Headquarters

California, United States

Tel: +1.510.337.6600

Email: [CustomerServicesUS@clearcom.com](mailto:CustomerServicesUS@clearcom.com)

Europe, Middle East, and Africa Headquarters

Cambridge, United Kingdom

Tel: +44 1223 815000

Email: [SalesSupportEMEA@clearcom.com](mailto:SalesSupportEMEA@clearcom.com)

Canada Office

Quebec, Canada

Tel: +1 (450) 653-9669

China Office

Beijing Representative Office

Beijing, P.R.China

Tel: +8610 65811360 / 65815577

# Contents

Contents 3

<b>1</b>	<b>Introduction.....</b>	<b>6</b>
1.1	Important Safety instructions .....	6
1.2	Further information .....	7
<b>2</b>	<b>Panels and Interfaces .....</b>	<b>8</b>
2.1	Main Station/Remote Station: Front panel.....	8
2.2	HMS-4X Main Station: rear panel .....	14
2.3	Remote Station rear panel .....	20
2.4	Speaker Station .....	23
2.5	HBP-2X Beltpack.....	29
<b>3</b>	<b>Installing HelixNet Partyline.....</b>	<b>34</b>
3.1	Planning your HelixNet Partyline installation .....	35
3.2	Installing the Main Station/Remote Station.....	40
3.3	Installing the Speaker Station .....	40
3.4	Installing the HBP-2X Beltpacks .....	43
<b>4</b>	<b>Configuring and managing the Main Station .....</b>	<b>44</b>
4.1	Using the Menus.....	44
4.2	Configuring the Audio settings .....	45
4.3	Selecting Station Settings .....	50
4.4	Configuring the channel settings.....	53
4.5	Configuring the Control I/O .....	55
4.6	Configuring Module Settings.....	57
4.7	Administration.....	65
4.8	Diagnostics .....	68
<b>5</b>	<b>Configuring and managing the Remote Station .....</b>	<b>71</b>
5.1	Configuring the audio settings.....	71
5.2	Selecting Station Settings .....	74
5.3	Configuring the channel settings.....	75
5.4	Configuring the Control I/O .....	76
5.5	Connecting the Remote Station to a Main Station using Ethernet .....	77

5.6	Administration.....	78
5.7	Diagnostics.....	80
<b>6</b>	<b>Configuring and managing the Speaker Station .....</b>	<b>82</b>
6.1	Using the Menus.....	82
6.2	Configuring the Audio settings .....	82
6.3	Station Settings .....	83
6.4	Connecting the Speaker Station to a Main Station .....	83
6.5	Administration.....	84
6.6	Diagnostics .....	84
<b>7</b>	<b>Configuring and managing the HBP-2X Beltpack .....</b>	<b>85</b>
7.1	Using the Menus.....	85
7.2	Configuring the Audio settings .....	86
7.3	Audio settings for the microphone.....	87
7.4	Configuring the Beltpack Settings .....	87
7.5	Configuring the Display Settings .....	89
7.6	Administration.....	90
7.7	Diagnostics .....	91
<b>8</b>	<b>Linking Main Stations.....</b>	<b>92</b>
8.1	Linking scenarios.....	92
8.2	Networking Specifications.....	100
<b>9</b>	<b>Linking Remote Stations and Speaker Stations .....</b>	<b>101</b>
9.1	Pairing scenarios .....	102
9.2	Networking Specifications.....	107
<b>10</b>	<b>Using the Main Station/Remote Station .....</b>	<b>108</b>
10.1	Using the gooseneck mic, loudspeaker and headset .....	108
10.2	Entering and exiting Menu mode .....	110
10.3	Using the channel keysets .....	110
10.4	Using the All Talk key .....	111
10.5	Using the SA [ <i>Stage Announce</i> ] key .....	111
10.6	Using the RMK [ <i>Remote Mic Kill</i> ] key.....	111
10.7	Line 1 and 2 LEDs .....	112
10.8	Line and LAN LEDs .....	112
<b>11</b>	<b>Using the HBP-2X Beltpack.....</b>	<b>113</b>

11.1	Using the beltpack keysets .....	113
11.2	Entering and exiting Menu mode .....	114
11.3	Adjusting the Program Feed volume level.....	114
<b>12</b>	<b>Using the Speaker Station .....</b>	<b>115</b>
12.1	Using the gooseneck mic, loudspeaker and headset .....	115
12.2	Entering and exiting Menu mode .....	116
12.3	Using the channel keysets .....	117
12.4	Line and LAN LEDs .....	118
<b>13</b>	<b>Connecting to Other Intercom Systems.....</b>	<b>119</b>
13.1	Connecting HelixNet Partyline to Encore® .....	119
13.2	Connecting HelixNet Partyline to RTS (Telex) two-wire systems .....	122
13.3	Connecting HelixNet Partyline to Tempest® .....	125
13.4	Connecting HelixNet Partyline to CellCom® / FreeSpeak® .....	131
13.5	Connecting HelixNet Partyline to the DX210.....	135
13.6	Connecting HelixNet Partyline to Eclipse® .....	140
13.7	Connecting HelixNet Partyline to two-way radio systems.....	145
<b>14</b>	<b>Specifications .....</b>	<b>152</b>
14.1	Main Station (HMS-4X).....	152
14.2	Two-wire module (HLI-2W2) .....	158
14.3	Four-wire module (HLI-4W2).....	159
14.4	Remote Station (HRM-4X) .....	159
14.5	Speaker Station (HKB-4X) .....	164
14.6	Beltpack (HBP-2X).....	167
<b>15</b>	<b>Compliance .....</b>	<b>169</b>
<b>16</b>	<b>Menu maps.....</b>	<b>171</b>
<b>17</b>	<b>Cabling reference .....</b>	<b>191</b>
17.1	Interoperability .....	191
17.2	Cable capacitance versus distance.....	192
<b>18</b>	<b>Troubleshooting .....</b>	<b>196</b>

# 1 Introduction

---

This guide is intended to help you install, configure, and use the **HelixNet Partyline™** system.

HelixNet Partyline is a digital intercom system, featuring the award-winning I.V Core Technology from Clear-Com®. The system is designed to be as simple to use and configure as a two-wire intercom / analog Partyline system, while exploiting the flexibility and network management capabilities of a matrix system.

To expedite integration with your existing intercom infrastructure, HelixNet Partyline also features:

- Highly configurable Control I/O and Module settings.
- Flexible cabling options (microphone cable, CAT5).
- Optional Two-wire and Four-wire interface modules.
- Optional Main Station linking (Ethernet or Fiber or combination).
- Beltpacks and wall/desktop Remote Stations that connect to a system that contains a Main Station.

## 1.1 Important Safety instructions

- Read these instructions.
- Keep these instructions.
- Heed all warnings.
- Follow all instructions.
- Do **not** use this apparatus near water.
- Clean only with dry cloth.
- Do **not** block any ventilation openings. Install in accordance with the manufacturer's instructions.
- Do **not** install near any heat sources such as radiators, heat registers, stoves, or other apparatus (including amplifiers) that produce heat.
- Do **not** defeat the safety purpose of the polarized or grounding-type plug. A polarized plug has two blades and a third grounding prong. The wide blade or the third prong is provided for your safety. If the provided plug does not fit into your outlet, consult an electrician for replacement of the obsolete outlet.
- Protect the power cord from being walked on or pinched particularly at plugs, convenience receptacles, and the point where they exit from the apparatus.
- Only use attachments/accessories specified by the manufacturer.

- Use only with the cart, stand, tripod, bracket, or table specified by the manufacturer, or sold with the apparatus. When a cart is used, use caution when moving the cart/apparatus combination to avoid injury from tip-over.
- Unplug this apparatus during lightning storms or when unused for long periods of time.
- Refer all servicing to qualified service personnel. Servicing is required when the apparatus has been damaged in any way, such as power-cord supply or plug is damaged, liquid has been spilled or objects have fallen into the apparatus, the apparatus has been exposed to rain or moisture, does not operate normally, or has been dropped.

**Warning:** To reduce the risk of fire or electric shock, do not expose this product to rain or moisture.

### 1.1.1 Safety symbols

Familiarize yourself with the safety symbols in **Figure 1: Safety symbols**. These symbols are displayed on the apparatus and warn you of the potential danger of electric shock if the system is used improperly.

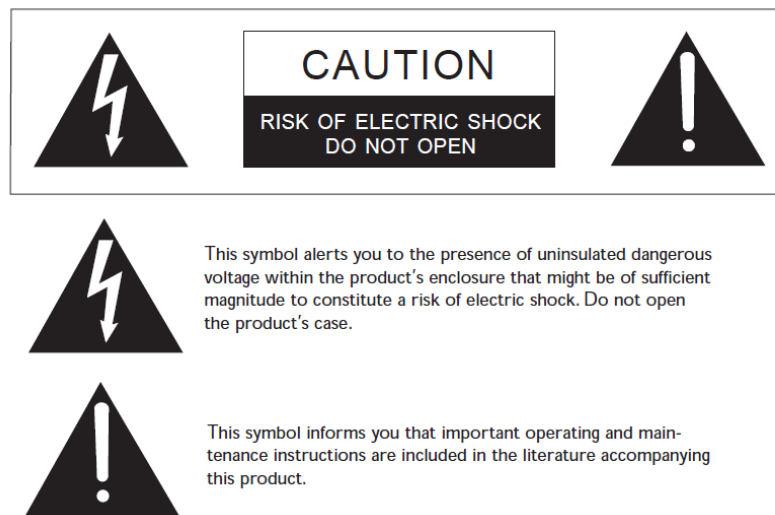

**Figure 1-1: Safety symbols**

**Note: Important.** For compliance notices, see 15 Compliance.

## 1.2 Further information

For the latest information about **HelixNet Partyline**, including software updates, see: <http://www.clearcom.com/product/helixnet>.

For information about **Clear-Com accessories**, including headsets and gooseneck microphones, see <http://www.clearcom.com/product/accessories>.

For **legal** and **contact** information, see Page 2 of this guide.

## 2 Panels and Interfaces

### 2.1 Main Station/Remote Station: Front panel

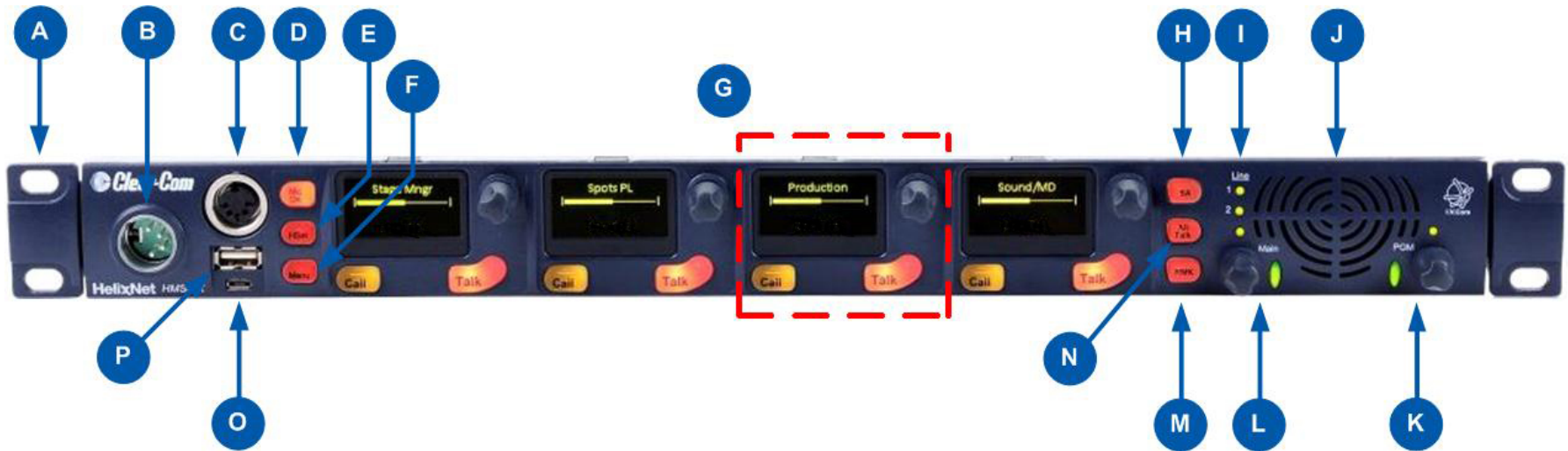

Figure 2-1: Main Station/Remote Station: Front panel



Key to Main Station/Remote Station: Front panel											
Feature	Description										
<b>A</b>	Ear for rack mounting Main Station/Remote Station.										
<b>B</b>	<p>Headset socket (4-pin XLR-M)</p> <table border="1"> <thead> <tr> <th>Pin</th> <th>Function</th> </tr> </thead> <tbody> <tr> <td>1</td> <td>Mic ground</td> </tr> <tr> <td>2</td> <td>Mic +</td> </tr> <tr> <td>3</td> <td>Earphone ground</td> </tr> <tr> <td>4</td> <td>Earphone</td> </tr> </tbody> </table> <p>Table 2-1: Headset socket pin out</p>	Pin	Function	1	Mic ground	2	Mic +	3	Earphone ground	4	Earphone
Pin	Function										
1	Mic ground										
2	Mic +										
3	Earphone ground										
4	Earphone										
<b>C</b>	Gooseneck microphone socket (3-pin female Tuchel connector)										
<b>D</b>	Mic control [ <b>MIC ON</b> ]. Press to activate mic audio.										
<b>E</b>	Headset key [ <b>HSET</b> ]. Press to activate the headset mic. When the headset is connected, the gooseneck microphone is disconnected. Audio output to the loudspeaker is diverted to the headphones.										
<b>F</b>	Menu. Press to display the main station menus in the display screens [ <b>G</b> ]. Use the rotary control for each display screen to scroll and select menu items. See 2.1.1 Main Station/Remote channel keyset.										
<b>G</b>	Channel keyset. There is a keyset (set of controls) dedicated to each of the four available channels. See 2.1.1 Main Station/Remote channel keyset.										
<b>H</b>	Stage Announce [ <b>SA</b> ]. Press to talk to connected Public Address (PA) / Stage Announce (SA) system (see 2.2 HMS-4X Main Station: rear panel). When the SA is pressed, Mic select [MIC ON] is also lit bright red, indicating that mic audio is active. See 10.5 Using the SA [Stage Announce] key.										

Key to Main Station/Remote Station: Front panel													
Feature	Description												
I	<p><b>Master Station</b>  <b>LEDs for lines 1 and 2 (partylines).</b> The LEDs indicate the status of the intercom circuit powering. When an LED is lit:</p> <ul style="list-style-type: none"> <li>Green, the line is functioning.</li> <li>Amber, the line is busy.</li> <li>Red, there is an error or fault on the line.</li> </ul> <p><b>Remote Station</b>  <b>LEDs for line status and LAN status.</b> The LEDs indicate the status of the intercom circuit powering. When an LED is lit:  Green, the line is functioning.  Amber, the line is busy.  Red, there is an error or fault on the line.</p> <p>If there is a fault on a powerline output, the Line STATUS indicator will turn off and the red FAULT indicator will flash. Possible causes of a fault include overvoltage, overcurrent, short circuit to ground or severe brown-outs.</p>												
J	<p><b>Loudspeaker.</b> When a headset is connected [ B ] and selected [ E ], loudspeaker output is diverted to the headphones.</p>												
K	<p><b>Program feed audio level rotary control [Program].</b></p> <ul style="list-style-type: none"> <li>To increase the volume of the program feed to the loudspeaker / headphones, turn clockwise (up to 360°).</li> <li>To decrease the volume, turn anticlockwise (up to 360°). As you increase or decrease the volume, the level control LEDs pass through a range of indicator colors:</li> </ul> <table border="1"> <thead> <tr> <th>LED color</th> <th>Volume level</th> </tr> </thead> <tbody> <tr> <td>Green</td> <td>Low</td> </tr> <tr> <td>Amber / Green</td> <td>Low / Medium</td> </tr> <tr> <td>Amber</td> <td>Medium</td> </tr> <tr> <td>Red / Amber</td> <td>Medium / High</td> </tr> <tr> <td>Red</td> <td>High</td> </tr> </tbody> </table> <p style="text-align: center;"><b>Table 2-2 : Volume Indicator colors</b></p>	LED color	Volume level	Green	Low	Amber / Green	Low / Medium	Amber	Medium	Red / Amber	Medium / High	Red	High
LED color	Volume level												
Green	Low												
Amber / Green	Low / Medium												
Amber	Medium												
Red / Amber	Medium / High												
Red	High												
L	<p><b>Loudspeaker / Headphone audio level rotary control [Main].</b> To increase the volume to the loudspeaker / headphones, turn clockwise (up to 360°). To decrease the volume, turn anticlockwise (up to 360°). Push to mute or unmute. As you increase or decrease the volume, the level control LEDs pass through a range of indicator colors. For more information, see <b>Table 2-2 : Volume Indicator colors</b></p>												
M	<p><b>Main Station:</b>  <b>Remote Mic Kill [RMK].</b> Press to:</p> <ul style="list-style-type: none"> <li>Turn off latched talk routes on all connected equipment.</li> </ul> <p><b>Remote Station:</b>  <b>Option [OPT] - Undefined</b></p>												



Key to Main Station/Remote Station: Front panel	
Feature	Description
	All Talk. Press to talk to all channels (intercom devices and systems) connected to the main station.
	USB 2.0 (Micro-AB) connector. For software upgrades (see <b>4.7.2 Updating the software and 4.7.6 Saving and restoring the software settings.</b> ). <b>Note:</b> This connector is not present on the Remote Station.
	USB 2.0 (Standard-A) connector. For software upgrades (see <b>4.7.2 Updating the software and 4.7.6 Saving and restoring the software settings.</b> ).

Table 2-3 Key to Main Station/Remote Station front panel diagram

**Note:** The Main Station/Remote Station does not have a power switch, button or key. The system powers up when you connect the power supply. Power up time depends on the amount of equipment connected.

## 2.1.1 Main Station/Remote channel keyset and display



Figure 2-2: Main Station/Remote Station (Front panel): Keyset

Key to Main Station/Remote Station front panel: Channel keyset	
Feature	Description
<b>A</b>	<p><b>Display screen.</b></p> <p>In Menu mode, the display screens display the four levels of menu. The menu hierarchy proceeds left to right:</p> <ul style="list-style-type: none"> <li>The top level menu is presented in the first screen (furthest left on the front panel).</li> <li>The lowest level menu is presented in the fourth screen (furthest right on the front panel).</li> </ul> <p>If the display is in Menu mode, the display screen times out of Menu mode and displays the channel label if no key is pressed for 20 seconds.</p> <p><i>For more information about Menu mode, see 4.1 Using the Menus.</i></p>
<b>B</b>	<p><b>Rotary control.</b> Turn to increase or decrease the listen volume level for the channel, or to scroll menu items when in menu mode. To select menu items, press the control.</p>
<b>C</b>	<p><b>Talk key.</b> Press to talk on the channel and to all nodes (intercom devices and systems) listening into the channel.</p>
<b>D</b>	<p><b>Call key.</b> Press to send a call signal to all nodes (intercom devices and systems) listening into the channel.</p>

Table 2-4: Key to Main Station/Remote Station front panel: Key Set

**Note:** If the Main Station/Remote Station remains inactive for 10 minutes, the display screens enter screensaver mode (see 4.3.7 Setting the screensaver).











Main Station/Remote Station display icons and indicators		
Name	Icon	Description
Channel label		A descriptive name for the channel. The maximum length is 10 characters.
Channel listen volume level		The volume of the channel audio.
Link		Appears on the Main Station when linking is enabled.
Broken link		Appears on the Main Station when a connection to a another Main Station is lost.
Pair		Appears on the Remote Station and Speaker Station when it is connected properly over Ethernet.
Broken pair		Flashes on the Remote Station and Speaker Station when the Ethernet connection is not configured properly.
Signal strength		Appears on the Remote Station, Speaker Station and beltpack. One to five bars indicate the strength of the signal from the Main Station.
Locked	Locked	Appears on the beltpack when you try to access the menu while the menu has been locked at the Main Station.
Mute		Appears on the Main Station, Remote Station and Speaker Station when the rotary control for any channel on the Main/Remote Station is pressed.
Opto		Appears on the Main Station and Remote Station close to the Call or Talk button if it is associated with an Opto.
Relay		Appears on the Main Station and Remote Station close to the Call or Talk button if it is associated with a Relay.
PGM	PGM	Appears on the Main Station, Remote Station, Speaker Station and beltpack when a program input is assigned to a channel.
IFB	IFB	Appears on the Main Station, Remote Station, Speaker Station and beltpack when a program input is assigned to a channel and IFB is enabled.
2W/4W	2W/4W	Appears on the Main Station, Remote Station and Speaker Station when a 2W/4W input is assigned to a channel.
LIM	LIM	Appears on the Main Station, Remote Station, Speaker Station and beltpack when the headset limiter is enabled.

Table 2-5 MainStation/Remote Station display icons and indicators

## 2.2 HMS-4X Main Station: rear panel

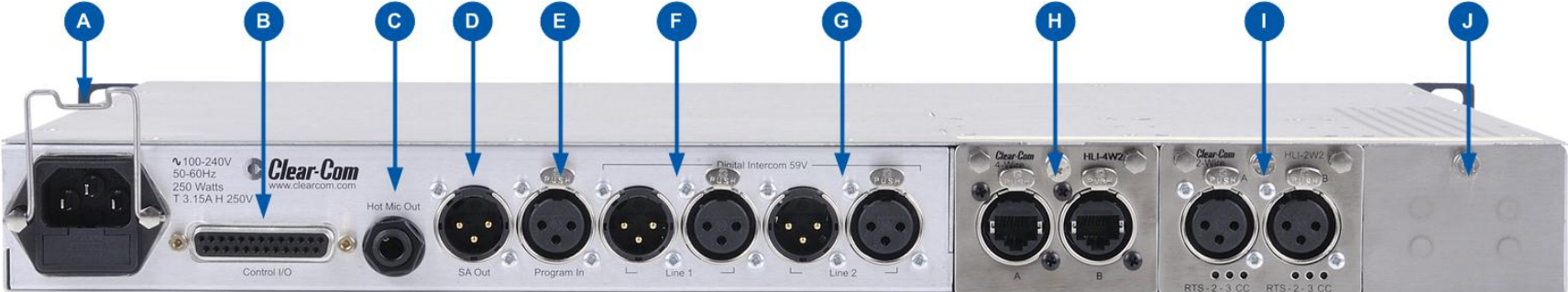

Figure 2-3: HMS-4X Main Station: rear panel (including optional modules HLI-2W2 and HLI-4W2)

Key to Main Station: rear panel																																																									
Feature	Description																																																								
<b>A</b>	<b>Power supply with metal cable clip.</b> The power supply operates at 100 - 240 VAC / 50-60Hz / 250 watts / T 3.15A H 250 V.																																																								
<b>B</b>	<p><b>Control I/O</b> (25 way female D-type). Use to connect up to 4 relay control outputs and 4 optically isolated control inputs (see <i>4.5 Configuring the Control I/O</i>).</p> <table border="1" style="margin-left: auto; margin-right: auto;"> <thead> <tr> <th>Pin</th> <th>Function</th> <th>Pin</th> <th>Function</th> </tr> </thead> <tbody> <tr> <td>Pin 1</td> <td>Relay 1 NC</td> <td>Pin 14</td> <td>Relay1 Pole</td> </tr> <tr> <td>Pin 2</td> <td>Relay 1-NO</td> <td>Pin 15</td> <td>Relay 2 NC</td> </tr> <tr> <td>Pin 3</td> <td>Relay2-Pole</td> <td>Pin 16</td> <td>Relay 2-NO</td> </tr> <tr> <td>Pin 4</td> <td>Relay 3 NC</td> <td>Pin 17</td> <td>Relay3 Pole</td> </tr> <tr> <td>Pin 5</td> <td>Relay 3-NO</td> <td>Pin 18</td> <td>Relay 4 NC</td> </tr> <tr> <td>Pin 6</td> <td>Relay4-Pole</td> <td>Pin 19</td> <td>Relay 4-NO</td> </tr> <tr> <td>Pin 7</td> <td></td> <td>Pin 20</td> <td>+5V</td> </tr> <tr> <td>Pin 8</td> <td>GND</td> <td>Pin 21</td> <td>+5V</td> </tr> <tr> <td>Pin 9</td> <td>GND</td> <td>Pin 22</td> <td>Opto 1-</td> </tr> <tr> <td>Pin 10</td> <td>Opto 1+</td> <td>Pin 23</td> <td>Opto 2-</td> </tr> <tr> <td>Pin 11</td> <td>Opto 2+</td> <td>Pin 24</td> <td>Opto 3-</td> </tr> <tr> <td>Pin 12</td> <td>Opto 3+</td> <td>Pin 25</td> <td>Opto 4-</td> </tr> <tr> <td>Pin 13</td> <td>Opto 4+</td> <td></td> <td></td> </tr> </tbody> </table> <p style="text-align: center;"><b>Table 2-6: Control I/O pin out</b></p>	Pin	Function	Pin	Function	Pin 1	Relay 1 NC	Pin 14	Relay1 Pole	Pin 2	Relay 1-NO	Pin 15	Relay 2 NC	Pin 3	Relay2-Pole	Pin 16	Relay 2-NO	Pin 4	Relay 3 NC	Pin 17	Relay3 Pole	Pin 5	Relay 3-NO	Pin 18	Relay 4 NC	Pin 6	Relay4-Pole	Pin 19	Relay 4-NO	Pin 7		Pin 20	+5V	Pin 8	GND	Pin 21	+5V	Pin 9	GND	Pin 22	Opto 1-	Pin 10	Opto 1+	Pin 23	Opto 2-	Pin 11	Opto 2+	Pin 24	Opto 3-	Pin 12	Opto 3+	Pin 25	Opto 4-	Pin 13	Opto 4+		
Pin	Function	Pin	Function																																																						
Pin 1	Relay 1 NC	Pin 14	Relay1 Pole																																																						
Pin 2	Relay 1-NO	Pin 15	Relay 2 NC																																																						
Pin 3	Relay2-Pole	Pin 16	Relay 2-NO																																																						
Pin 4	Relay 3 NC	Pin 17	Relay3 Pole																																																						
Pin 5	Relay 3-NO	Pin 18	Relay 4 NC																																																						
Pin 6	Relay4-Pole	Pin 19	Relay 4-NO																																																						
Pin 7		Pin 20	+5V																																																						
Pin 8	GND	Pin 21	+5V																																																						
Pin 9	GND	Pin 22	Opto 1-																																																						
Pin 10	Opto 1+	Pin 23	Opto 2-																																																						
Pin 11	Opto 2+	Pin 24	Opto 3-																																																						
Pin 12	Opto 3+	Pin 25	Opto 4-																																																						
Pin 13	Opto 4+																																																								
<b>C</b>	<p><b>Hot Mic output.</b> This connection is a 1/4-in (0.64 cm) phone jack. It provides an output signal from the selected headset or panel microphone. The Hot Mic output is always live. Audio from the mic is routed through the Hot Mic output even if the mic is inactive (off).</p> <table border="1" style="margin-left: auto; margin-right: auto;"> <thead> <tr> <th>Pin</th> <th>Function</th> </tr> </thead> <tbody> <tr> <td>Tip</td> <td>Mic</td> </tr> <tr> <td>Ring</td> <td>IFB mute signal</td> </tr> <tr> <td>Sleeve</td> <td>Ground</td> </tr> </tbody> </table> <p style="text-align: center;"><b>Table 2-7: Hot Mic pin out</b></p>	Pin	Function	Tip	Mic	Ring	IFB mute signal	Sleeve	Ground																																																
Pin	Function																																																								
Tip	Mic																																																								
Ring	IFB mute signal																																																								
Sleeve	Ground																																																								

<p><b>D</b></p>	<p><b>SA [Stage Announce] line out (3-pin male XLR).</b></p> <table border="1" data-bbox="576 241 1356 420"> <thead> <tr> <th>Pin</th> <th>Function</th> </tr> </thead> <tbody> <tr> <td>Pin 1</td> <td>Ground</td> </tr> <tr> <td>Pin 2</td> <td>Positive</td> </tr> <tr> <td>Pin 3</td> <td>Negative</td> </tr> </tbody> </table> <p style="text-align: center;"><b>Table 2-8: SA pin out</b></p>	Pin	Function	Pin 1	Ground	Pin 2	Positive	Pin 3	Negative
Pin	Function								
Pin 1	Ground								
Pin 2	Positive								
Pin 3	Negative								
<p><b>E</b></p>	<p><b>Program Input (3-pin female XLR).</b></p> <table border="1" data-bbox="576 567 1356 745"> <thead> <tr> <th>Pin</th> <th>Function</th> </tr> </thead> <tbody> <tr> <td>Pin 1</td> <td>Ground</td> </tr> <tr> <td>Pin 2</td> <td>Positive</td> </tr> <tr> <td>Pin 3</td> <td>Negative</td> </tr> </tbody> </table> <p style="text-align: center;"><b>Table 2-9: Program input pin out</b></p>	Pin	Function	Pin 1	Ground	Pin 2	Positive	Pin 3	Negative
Pin	Function								
Pin 1	Ground								
Pin 2	Positive								
Pin 3	Negative								
<p><b>F</b></p>	<p><b>Line 1 (partyline). (3-pin male and female XLR connectors).</b></p> <table border="1" data-bbox="576 892 1356 1071"> <thead> <tr> <th>Pin</th> <th>Function</th> </tr> </thead> <tbody> <tr> <td>Pin 1</td> <td>Ground</td> </tr> <tr> <td>Pin 2</td> <td>+30V DC and Audio</td> </tr> <tr> <td>Pin 3</td> <td>-30V DC and Audio</td> </tr> </tbody> </table> <p style="text-align: center;"><b>Table 2-10: Line 1 pin out</b></p>	Pin	Function	Pin 1	Ground	Pin 2	+30V DC and Audio	Pin 3	-30V DC and Audio
Pin	Function								
Pin 1	Ground								
Pin 2	+30V DC and Audio								
Pin 3	-30V DC and Audio								
<p><b>G</b></p>	<p><b>Line 2 (partyline). (3-pin male and female XLR connectors).</b></p> <table border="1" data-bbox="576 1218 1356 1396"> <thead> <tr> <th>Pin</th> <th>Function</th> </tr> </thead> <tbody> <tr> <td>Pin 1</td> <td>Ground</td> </tr> <tr> <td>Pin 2</td> <td>+30V DC and Audio</td> </tr> <tr> <td>Pin 3</td> <td>-30V DC and Audio</td> </tr> </tbody> </table> <p style="text-align: center;"><b>Table 2-11: Line 2 pin out</b></p>	Pin	Function	Pin 1	Ground	Pin 2	+30V DC and Audio	Pin 3	-30V DC and Audio
Pin	Function								
Pin 1	Ground								
Pin 2	+30V DC and Audio								
Pin 3	-30V DC and Audio								
<p><b>H</b></p>	<p>Slots for optional interface modules. For more information, see <b>HMS-4X Main Station rear panel: Interface modules.</b></p>								
<p><b>I</b></p>									
<p><b>J</b></p>									

**Table 2-12: Key to HMS-4X Main Station rear panel diagram**

**Warning:** Only connect power supply to earthed supply sockets. Ensure that the power supply is routed to avoid sharp bends, hot surfaces, pinches and abrasion. For more safety guidance, see the Safety Instructions at the front of this guide.





**Note:** The HMS-4X Main Station does not have a power switch, button or key. The system powers up when you connect the power supply.

## 2.2.1 HMS-4X Main Station rear panel: Interface modules

Up to three Interface modules (of the same or different types) can be fitted to the extension bay of the main station. When looking at the rear of the Main Station, expansion slot 1 is the left-hand slot, expansion slot 2 is the middle slot, and expansion slot 3 is the right-hand slot.

**Warning:** The interface modules are not hot pluggable. Ensure that the Main Station is powered down before inserting or removing modules.

Interface module	Description								
<p>Two-wire interface module (HLI-2W2)</p> 	<p>This is a two channel device that enables interoperability with Tempest®, CellCom® / FreeSpeak®, and HME DX210 systems, as well as both Clear-Com and RTS analog partyline systems.</p> <p><b>Note:</b> This module requires a powered analog party line.</p> <p>The module provides two analog partyline connectors (3 pin female XLR connectors) with the following pin out:</p> <table border="1" data-bbox="618 842 1398 1052"> <thead> <tr> <th>Pin</th> <th>Function</th> </tr> </thead> <tbody> <tr> <td>1</td> <td>Ground</td> </tr> <tr> <td>2</td> <td>Power [Option for RTS mode: power and audio]</td> </tr> <tr> <td>3</td> <td>Audio</td> </tr> </tbody> </table> <p style="text-align: center;"><b>Table 2-13: two-wire Interface Module pin out</b></p> <p>Use HelixNet main station menus to set the module for either RTS or Clear-Com systems. If RTS mode is selected, you can set either:</p> <ul style="list-style-type: none"> <li>• Pin 2 for power to mixed audio channel 1 or 3</li> <li>• Pin 3 for power to mixed audio channel 2 or 4</li> </ul>	Pin	Function	1	Ground	2	Power [Option for RTS mode: power and audio]	3	Audio
Pin	Function								
1	Ground								
2	Power [Option for RTS mode: power and audio]								
3	Audio								

Interface module	Description																											
<p data-bbox="284 216 527 279">Four-wire interface module (HLI-4W2)</p> 	<p data-bbox="617 216 1477 447">This is a two channel device that enables interoperability with the Eclipse® digital matrix system and other four-wire audio sources such as telephone hybrids, AB-120/-100, PA (Public Address) / SA (Stage Announce) systems. The module also enables HelixNet-to-HelixNet connections using four-wire audio ports. Two four-wire connectors (Ethercon type RJ45 socket) are provided with the following pin out:</p> <table border="1" data-bbox="617 453 1398 856"> <thead> <tr> <th>Pin</th> <th>Function</th> </tr> </thead> <tbody> <tr> <td>1</td> <td>RS-422 data TX+</td> </tr> <tr> <td>2</td> <td>RS-422 data TX-</td> </tr> <tr> <td>3</td> <td>Audio send +</td> </tr> <tr> <td>4</td> <td>Audio receive +</td> </tr> <tr> <td>5</td> <td>Audio receive -</td> </tr> <tr> <td>6</td> <td>Audio send -</td> </tr> <tr> <td>7</td> <td>RS-422 data RX+</td> </tr> <tr> <td>8</td> <td>RS-422 data RX-</td> </tr> </tbody> </table> <p data-bbox="760 877 1339 909"><b>Table 2-14: four-wire interface module pin out</b></p>	Pin	Function	1	RS-422 data TX+	2	RS-422 data TX-	3	Audio send +	4	Audio receive +	5	Audio receive -	6	Audio send -	7	RS-422 data RX+	8	RS-422 data RX-									
Pin	Function																											
1	RS-422 data TX+																											
2	RS-422 data TX-																											
3	Audio send +																											
4	Audio receive +																											
5	Audio receive -																											
6	Audio send -																											
7	RS-422 data RX+																											
8	RS-422 data RX-																											
<p data-bbox="284 930 527 993">Ethernet interface module (HLI-ET2)</p> 	<p data-bbox="617 930 1477 1035">Enables linking of Main Stations, and connection of Remote Stations and Speaker Stations via Ethernet. Contains Two 10/100 Mbps RJ45 EtherCON ports.</p> <table border="1" data-bbox="617 1041 1474 1444"> <thead> <tr> <th>Pin</th> <th>Name</th> <th>Function</th> </tr> </thead> <tbody> <tr> <td>1</td> <td>TX+</td> <td>Transmit Data+</td> </tr> <tr> <td>2</td> <td>TX-</td> <td>Transmit Data-</td> </tr> <tr> <td>3</td> <td>RX+</td> <td>Receive Data+</td> </tr> <tr> <td>4</td> <td>n/c</td> <td>Not connected</td> </tr> <tr> <td>5</td> <td>n/c</td> <td>Not connected</td> </tr> <tr> <td>6</td> <td>RX-</td> <td>Receive Data-</td> </tr> <tr> <td>7</td> <td>n/c</td> <td>Not connected</td> </tr> <tr> <td>8</td> <td>n/c</td> <td>Not connected</td> </tr> </tbody> </table> <p data-bbox="760 1465 1339 1497"><b>Table 2-15: Ethernet interface module pin out</b></p> <div data-bbox="638 1514 727 1591"> </div> <p data-bbox="768 1514 1461 1675"><b>Warning:</b> Both ports are configured to bridge traffic from one port to the other in order to work in a daisy-chained configuration. Spanning Tree Protocol is not enabled on these ports, therefore do not connect them both to the same network.</p>	Pin	Name	Function	1	TX+	Transmit Data+	2	TX-	Transmit Data-	3	RX+	Receive Data+	4	n/c	Not connected	5	n/c	Not connected	6	RX-	Receive Data-	7	n/c	Not connected	8	n/c	Not connected
Pin	Name	Function																										
1	TX+	Transmit Data+																										
2	TX-	Transmit Data-																										
3	RX+	Receive Data+																										
4	n/c	Not connected																										
5	n/c	Not connected																										
6	RX-	Receive Data-																										
7	n/c	Not connected																										
8	n/c	Not connected																										

Interface module	Description
<p data-bbox="284 216 581 281">Fiber interface module (HLI-FBS)</p> 	<p data-bbox="618 216 1451 352">Enables linking of Main Stations, and connection of Remote Stations and Speaker Stations via a fiber link. Contains two SFP cage slots. The module is supplied with one transceiver fitted. Any 100BASE-X SFP can be connected.</p> <div data-bbox="639 401 727 485" style="display: inline-block; vertical-align: middle;"> </div> <p data-bbox="768 405 1451 567"><b>Warning:</b> Both ports are configured to bridge traffic from one port to the other in order to work in a daisy-chained configuration. Spanning Tree Protocol is not enabled on these ports, therefore do not connect them both to the same network.</p>

**Table 2-16: HMS-4X Main Station rear panel: Interface Modules**

## 2.3 Remote Station rear panel

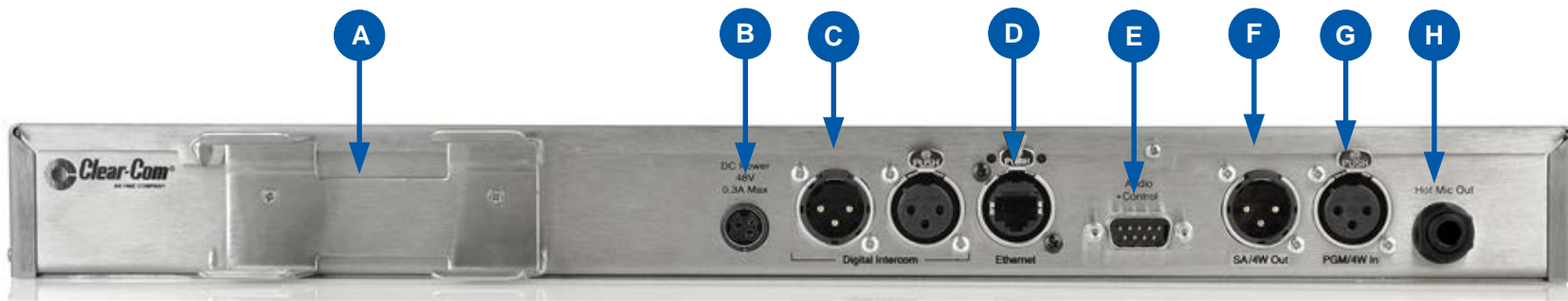

Figure 2-4 HRM-4X Remote Station rear panel

Key to Remote Station: rear panel																					
Feature	Description																				
<b>A</b>	PSU holder for a separate external AC-DC power supply. The external PSU provides the 48V required and at its input takes 100-240V, 50-60Hz.																				
<b>B</b>	<b>Power supply.</b> The power input connector is a low voltage DC connection. It is 48VDC at a max power of 12.95W.																				
<b>C</b>	<p><b>Line 1 (partyline). (3-pin male and female XLR connectors).</b></p> <table border="1"> <thead> <tr> <th>Pin</th> <th>Function</th> </tr> </thead> <tbody> <tr> <td>Pin 1</td> <td>Ground</td> </tr> <tr> <td>Pin 2</td> <td>+30V DC and Audio</td> </tr> <tr> <td>Pin 3</td> <td>-30V DC and Audio</td> </tr> </tbody> </table> <p style="text-align: center;"><b>Table 2-17: Line 1 pin out</b></p>	Pin	Function	Pin 1	Ground	Pin 2	+30V DC and Audio	Pin 3	-30V DC and Audio												
Pin	Function																				
Pin 1	Ground																				
Pin 2	+30V DC and Audio																				
Pin 3	-30V DC and Audio																				
<b>D</b>	<b>Power Over Ethernet (RJ45 connector)</b>																				
<b>E</b>	<p><b>Control input/output (DB9 connector)</b></p> <table border="1"> <thead> <tr> <th>Pin</th> <th>Function</th> </tr> </thead> <tbody> <tr> <td>Pin 1</td> <td>Audio out +</td> </tr> <tr> <td>Pin 2</td> <td>Audio in +</td> </tr> <tr> <td>Pin 3</td> <td>GND</td> </tr> <tr> <td>Pin 4</td> <td>Relay NC</td> </tr> <tr> <td>Pin 5</td> <td>Relay NO</td> </tr> <tr> <td>Pin 6</td> <td>Audio out -</td> </tr> <tr> <td>Pin 7</td> <td>Audio in -</td> </tr> <tr> <td>Pin 8</td> <td>Opto</td> </tr> <tr> <td>Pin 9</td> <td>Relay pole</td> </tr> </tbody> </table> <p style="text-align: center;"><b>Table 2-18 Control input/output pinout</b></p> <p>The audio connections in this connector are wired directly to the SA and program connectors. Only one or the other can be used at one time.</p>	Pin	Function	Pin 1	Audio out +	Pin 2	Audio in +	Pin 3	GND	Pin 4	Relay NC	Pin 5	Relay NO	Pin 6	Audio out -	Pin 7	Audio in -	Pin 8	Opto	Pin 9	Relay pole
Pin	Function																				
Pin 1	Audio out +																				
Pin 2	Audio in +																				
Pin 3	GND																				
Pin 4	Relay NC																				
Pin 5	Relay NO																				
Pin 6	Audio out -																				
Pin 7	Audio in -																				
Pin 8	Opto																				
Pin 9	Relay pole																				
<b>F</b>	<p><b>SA [Stage Announce] line out (3-pin female XLR).</b></p> <table border="1"> <thead> <tr> <th>Pin</th> <th>Function</th> </tr> </thead> <tbody> <tr> <td>Pin 1</td> <td>Ground</td> </tr> <tr> <td>Pin 2</td> <td>Positive</td> </tr> <tr> <td>Pin 3</td> <td>Negative</td> </tr> </tbody> </table> <p style="text-align: center;"><b>Table 2-19 SA pinout</b></p>	Pin	Function	Pin 1	Ground	Pin 2	Positive	Pin 3	Negative												
Pin	Function																				
Pin 1	Ground																				
Pin 2	Positive																				
Pin 3	Negative																				

Key to Remote Station: rear panel									
Feature	Description								
<b>G</b>	<p><b>Program Input (3-pin m XLR).</b></p> <table border="1"> <thead> <tr> <th>Pin</th> <th>Function</th> </tr> </thead> <tbody> <tr> <td>Pin 1</td> <td>Ground</td> </tr> <tr> <td>Pin 2</td> <td>Positive</td> </tr> <tr> <td>Pin 3</td> <td>Negative</td> </tr> </tbody> </table> <p style="text-align: center;"><b>Table 2-20 Program input pinout</b></p>	Pin	Function	Pin 1	Ground	Pin 2	Positive	Pin 3	Negative
Pin	Function								
Pin 1	Ground								
Pin 2	Positive								
Pin 3	Negative								
<b>H</b>	<p><b>Hot Mic output.</b> This connection is a 1/4-in (0.64 cm) phone jack. It provides an output signal from the selected headset or panel microphone. The Hot Mic output is always live. Audio from the mic is routed through the Hot Mic output even if the mic is inactive (off).</p> <table border="1"> <thead> <tr> <th>Pin</th> <th>Function</th> </tr> </thead> <tbody> <tr> <td>Tip</td> <td>Mic</td> </tr> <tr> <td>Ring</td> <td>IFB mute signal</td> </tr> <tr> <td>Sleeve</td> <td>Ground</td> </tr> </tbody> </table> <p style="text-align: center;"><b>Table 2-21: Hot Mic pin out</b></p>	Pin	Function	Tip	Mic	Ring	IFB mute signal	Sleeve	Ground
Pin	Function								
Tip	Mic								
Ring	IFB mute signal								
Sleeve	Ground								

**Table 2-22: Key to Remote Station rear panel diagram**

2.4 Speaker Station

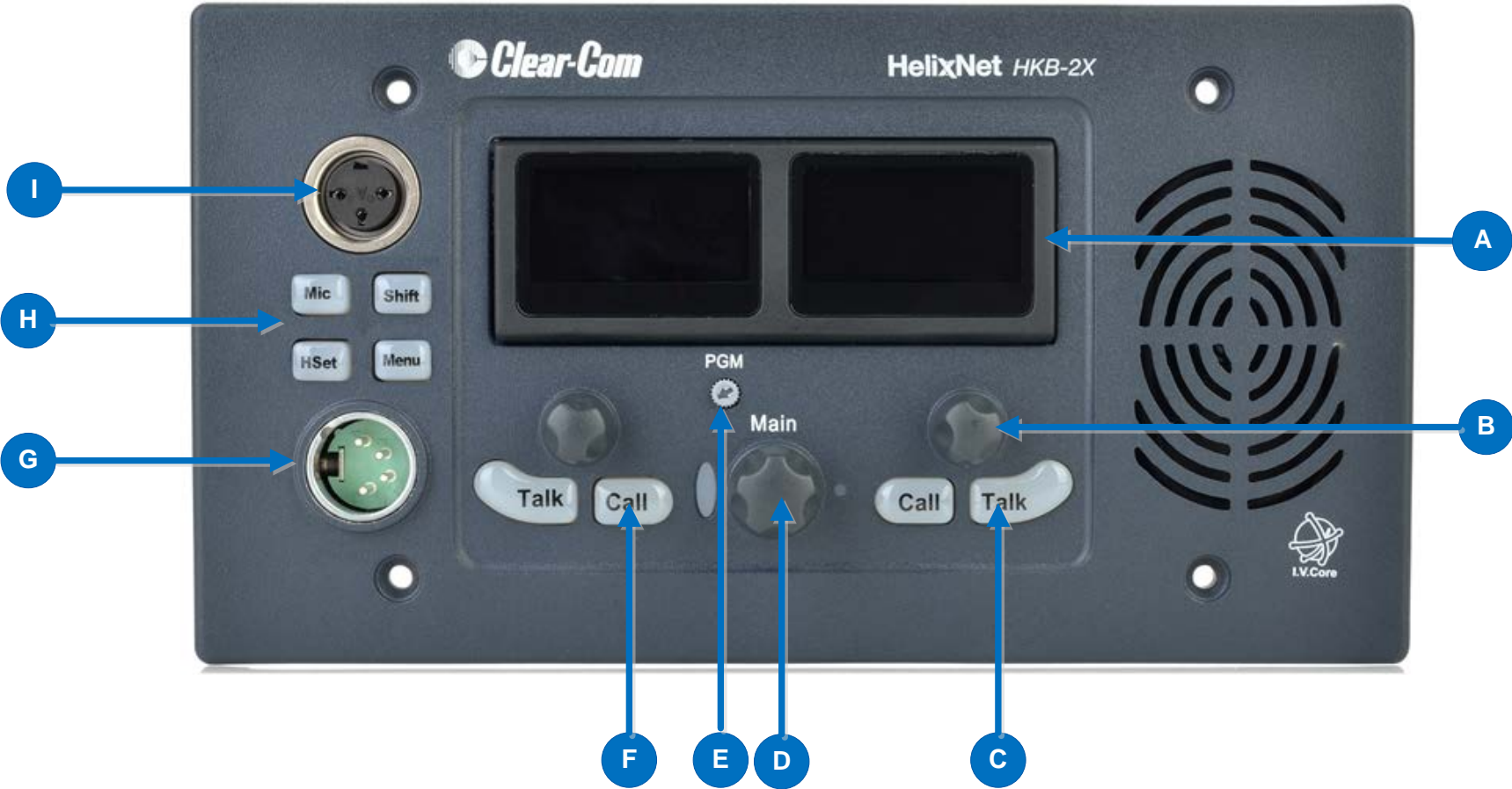

Figure 2-5 Speaker Station front panel

Key to Speaker Station front panel											
Feature	Description										
<b>A</b>	<p><b>Tilt adjustable display screen.</b> The following default information is displayed:</p> <ul style="list-style-type: none"> <li>• The channel label.</li> <li>• The channel listen (volume) level.</li> </ul> <p>For a full description of the display screen information, see <b>Table 2-5 MainStation/Remote Station display icons and indicators.</b></p> <p>In Menu mode, the display screens display the four levels of menu. The menu hierarchy proceeds left to right:</p> <ul style="list-style-type: none"> <li>• The top level menu is presented in the first screen (furthest left on the front panel).</li> <li>• The lowest level menu is presented in the fourth screen (furthest right on the front panel).</li> </ul> <p>If the display is in Menu mode, the display screen times out of Menu mode and displays the channel label if no key is pressed for 20 seconds.</p> <p><i>For more information about Menu mode, see 4.1 Using the Menus.</i></p>										
<b>B</b>	<p><b>Rotary control.</b> Turn to increase or decrease the listen volume level for the channel, or to scroll menu items when in menu mode. To select menu items, push the control.</p>										
<b>C</b>	<p><b>Talk key.</b> Press to talk on the channel and to all nodes (intercom devices and systems) listening into the channel.</p>										
<b>D</b>	<p><b>Loudspeaker / Headphone audio level rotary control [Main].</b> To increase the volume to the loudspeaker / headphones, turn clockwise (up to 360°). To decrease the volume, turn anticlockwise (up to 360°). As you increase or decrease the volume, the level control LEDs pass through a range of indicator colors. For more information, see <b>Table 2-2 : Volume Indicator colors</b></p>										
<b>E</b>	<p><b>Program feed audio level rotary control [PGM].</b> To increase the volume of the program feed to the loudspeaker / headphones, turn clockwise (up to 360°). To decrease the volume, turn anticlockwise (up to 360°).</p>										
<b>F</b>	<p><b>Call key.</b> Press to send a call signal to all nodes (intercom devices and systems) listening into the channel. There are two Call keys on the beltpack, one for each of the displayed channels.</p>										
<b>G</b>	<p><b>Headset socket (4-pin XLR-M)</b></p> <table border="1"> <thead> <tr> <th>Pin</th> <th>Function</th> </tr> </thead> <tbody> <tr> <td>1</td> <td>Mic ground</td> </tr> <tr> <td>2</td> <td>Mic positive</td> </tr> <tr> <td>3</td> <td>Earphone ground</td> </tr> <tr> <td>4</td> <td>Earphone positive</td> </tr> </tbody> </table> <p style="text-align: center;"><b>Table 2-23 : Headset socket pin out</b></p>	Pin	Function	1	Mic ground	2	Mic positive	3	Earphone ground	4	Earphone positive
Pin	Function										
1	Mic ground										
2	Mic positive										
3	Earphone ground										
4	Earphone positive										
<b>H</b>	<p><b>Headset/microphone key set.</b> There is a keyset (set of controls) to control the headset/microphone inputs and menu options. See Figure 2-6 Speaker Station keyset.</p>										
<b>I</b>	<p><b>Gooseneck microphone connector</b> (3-pin female Tuchel connector)</p>										

Table 2-24 Key to Speaker Station front panel



## 2.4.1 Speaker Station front panel function buttons

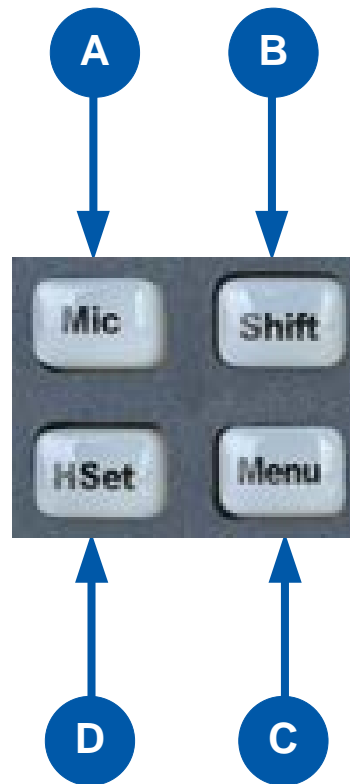
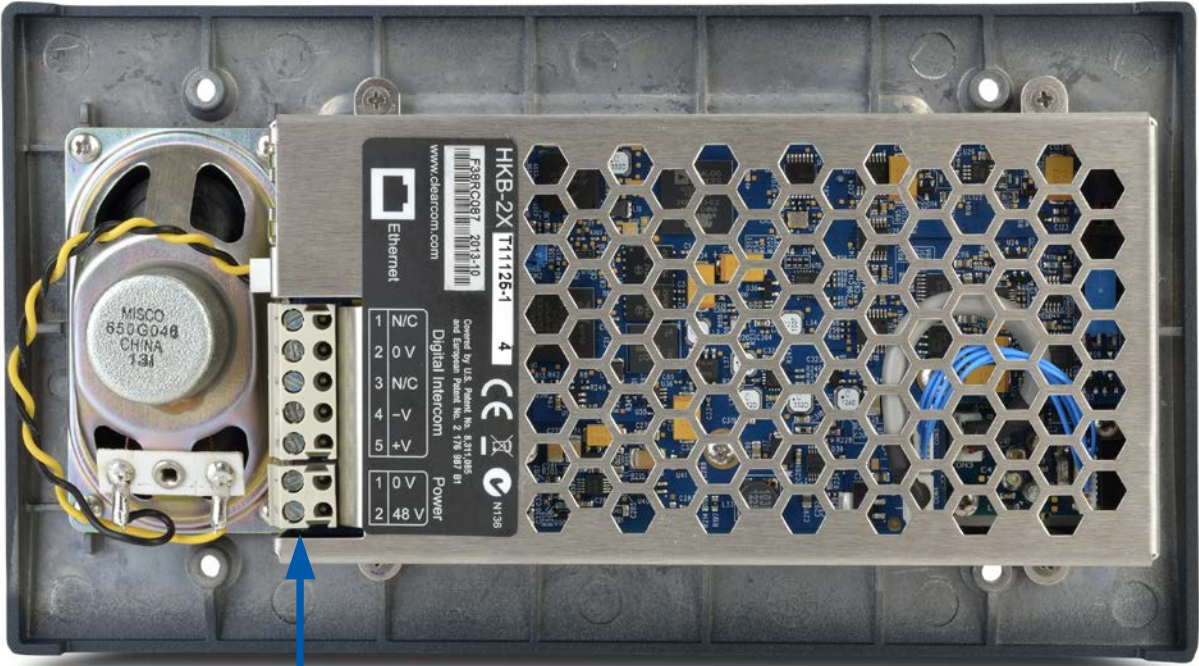

Figure 2-6 Speaker Station keyset

Key to Speaker Station front panel function buttons	
Feature	Description
<b>A</b>	<b>Mic control [ MIC ON].</b> Press to activate mic audio.
<b>B</b>	<b>Shift key.</b> Press to display two alternative channels on the Speaker Station displays.
<b>C</b>	<b>Menu.</b> Press to display the Speaker Station menus in the display screens. Use the rotary control for each display screen to scroll and select menu items.
<b>D</b>	<b>Headset key [ HSET].</b> Press to activate the headset mic. When the headset is connected, the gooseneck microphone is disconnected. Audio output to the loudspeaker is diverted to the headphones.

Table 2-25 Key to Speaker Station front panel keyset

### 2.4.2 Speaker Station rear panel



Digital intercom screw terminals

### 2.4.3 S-Mount rear panel

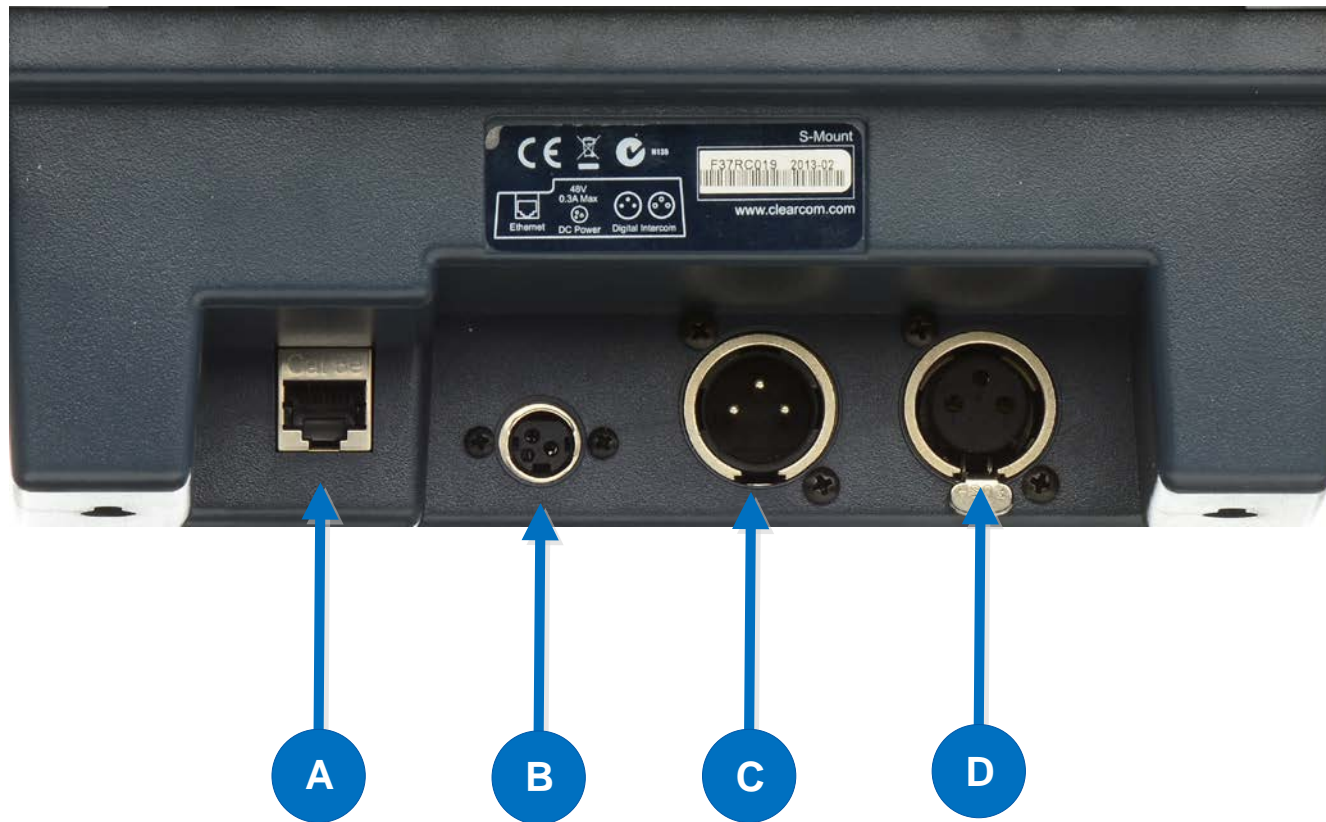

Key to S-Mount rear panel keyset									
Feature	Description								
<b>A</b>	Ethernet/Power over Ethernet connection (RJ45)								
<b>B</b>	Power connection.								
<b>C</b>	<p>Line 1 Party Line in. (3-pin male XLR connector).</p> <table border="1"> <thead> <tr> <th>Pin</th> <th>Function</th> </tr> </thead> <tbody> <tr> <td>Pin 1</td> <td>Ground</td> </tr> <tr> <td>Pin 2</td> <td>+30V DC and Audio</td> </tr> <tr> <td>Pin 3</td> <td>-30V DC and Audio</td> </tr> </tbody> </table> <p style="text-align: center;"><b>Table 2-26 Line 1 pinout</b></p>	Pin	Function	Pin 1	Ground	Pin 2	+30V DC and Audio	Pin 3	-30V DC and Audio
Pin	Function								
Pin 1	Ground								
Pin 2	+30V DC and Audio								
Pin 3	-30V DC and Audio								
<b>D</b>	<p>Line 2 Party Line out.(3-pin female XLR connector).</p> <table border="1"> <thead> <tr> <th>Pin</th> <th>Function</th> </tr> </thead> <tbody> <tr> <td>Pin 1</td> <td>Ground</td> </tr> <tr> <td>Pin 2</td> <td>+30V DC and Audio</td> </tr> <tr> <td>Pin 3</td> <td>-30V DC and Audio</td> </tr> </tbody> </table> <p style="text-align: center;"><b>Table 2-27 Line 1 pinout</b></p>	Pin	Function	Pin 1	Ground	Pin 2	+30V DC and Audio	Pin 3	-30V DC and Audio
Pin	Function								
Pin 1	Ground								
Pin 2	+30V DC and Audio								
Pin 3	-30V DC and Audio								

**Table 2-28 Key to S-Mount rear panel**

2.5 HBP-2X Beltpack

2.5.1 HBP-2X user controls (front and side view)



Figure 2-7: HBP-2X beltpack (front and side view)

Key to HBP-2X user controls (front and side view)	
Feature	Description
<b>A</b>	<b>Menu key.</b> Press firmly to enter Menu mode (see also <b>D</b> <b>E</b> ). To exit Menu mode, press the Menu key again. The display screen times out of Menu mode and displays the channel label(s) if no key is pressed for 20 seconds.
<b>B</b>	<b>USB 2.0 (Micro-AB) connector.</b> For software upgrades.
<b>C</b>	<b>Casing.</b> Metal casing for robust use. For information about the beltclip, beltloops, and feet, see 2.5.3 <i>HBP-2X beltclip, beltloops and feet (base view)</i> .
Keypad	
<b>D</b>	<b>Rotary control.</b> Turn to increase and decrease the listen volume level for the channel. In Menu mode, you can turn either of the side-mounted rotary controls to scroll menu items. To select (enter) items, press the right-hand Call key (see <b>F</b> ).
<b>E</b>	<b>Call key.</b> Press to send a call signal to all nodes (intercom devices and systems) listening into the channel. There are two Call keys on the beltpack, one for each of the supported channels. In Menu mode, press the right-hand Call key to select (enter) menu items (see also <b>A</b> <b>D</b> ). Use the left-hand Call key to go back one menu level.
<b>F</b>	<b>Talk key.</b> Press to talk to all nodes (intercom devices and systems) listening into the channel. There are two Talk keys on the beltpack, one for each of the supported channels.
<b>G</b>	<b>Display screen.</b> When the beltpack is not in Menu mode, the labels and volume level for each of the two channels supported by the beltpack are displayed on screen. For a full description of the display screen information, see <b>Table 2-5 MainStation/Remote Station display icons and indicators</b> .

Table 2-29: Key to HBP-2X Beltpack (front and side view)



## 2.5.2 HBP-2X connectors and controls (rear view)

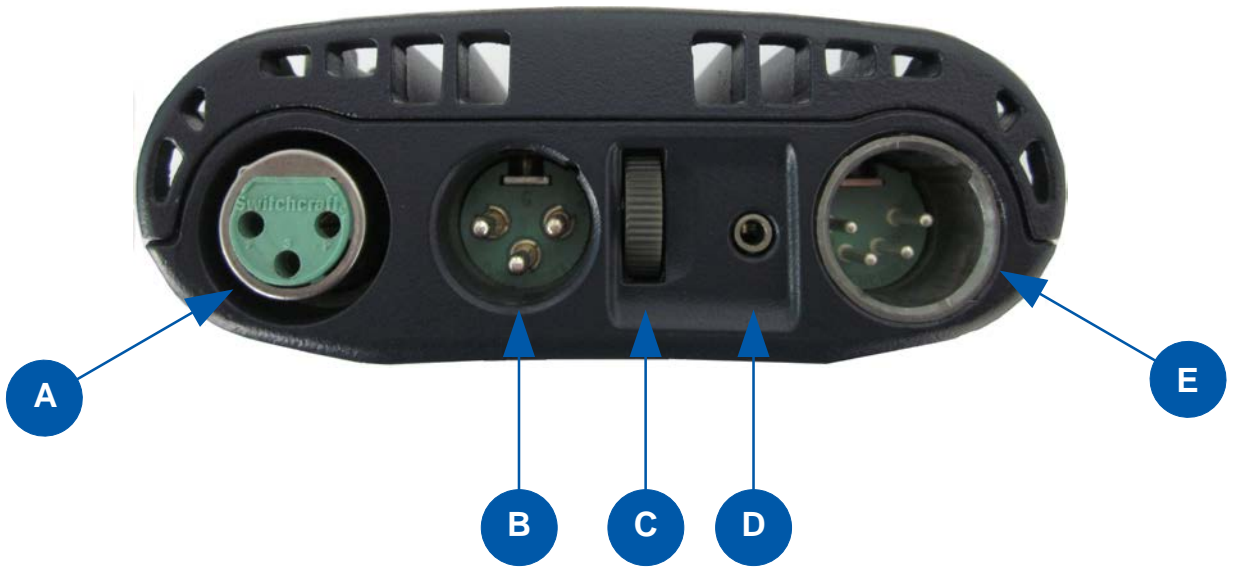

Figure 2-8: HBP-2X connectors and controls (rear view)

Key to HBP-2X Beltpack (Rear view)									
Feature	Description								
<b>A</b>	<p><b>Line (Partyline)</b> (3-pin female XLR connector).</p> <table border="1"> <thead> <tr> <th>Pin</th> <th>Function</th> </tr> </thead> <tbody> <tr> <td>1</td> <td>Ground</td> </tr> <tr> <td>2</td> <td>+30V DC and Audio</td> </tr> <tr> <td>3</td> <td>-30V DC and Audio</td> </tr> </tbody> </table> <p style="text-align: center;"><b>Table 2-30: Line (female) pin out</b></p>	Pin	Function	1	Ground	2	+30V DC and Audio	3	-30V DC and Audio
Pin	Function								
1	Ground								
2	+30V DC and Audio								
3	-30V DC and Audio								
<b>B</b>	<p><b>Line (Partyline)</b> (3-pin male XLR connector). Pass-through for daisy chain connection (see <i>Figure 3-2: Example system topologies (layouts)</i>).</p> <table border="1"> <thead> <tr> <th>Pin</th> <th>Function</th> </tr> </thead> <tbody> <tr> <td>1</td> <td>Ground</td> </tr> <tr> <td>2</td> <td>+30V DC and Audio</td> </tr> <tr> <td>3</td> <td>-30V DC and Audio</td> </tr> </tbody> </table> <p style="text-align: center;"><b>Table 2-31: Line (male) pin out</b></p>	Pin	Function	1	Ground	2	+30V DC and Audio	3	-30V DC and Audio
Pin	Function								
1	Ground								
2	+30V DC and Audio								
3	-30V DC and Audio								
<b>C</b>	<p><b>Program feed (volume) control wheel.</b> Turn to increase or decrease the overall listen volume level of the program feed. To assign programs to a channel, see <b>4.4.2 Assigning the Program Listen to a channel</b>.</p>								
<b>D</b>	<p><b>2.5 mm TRS headset input.</b></p>								

Key to HBP-2X Beltpack (Rear view)													
Feature	Description												
E	<b>Headset connector</b> (4-pin male or 5-pin female XLR connector).												
	<table border="1"> <thead> <tr> <th>Pin</th> <th>Function</th> </tr> </thead> <tbody> <tr> <td>1</td> <td>Mic ground</td> </tr> <tr> <td>2</td> <td>Mic positive</td> </tr> <tr> <td>3</td> <td>Earphone ground</td> </tr> <tr> <td>4</td> <td>Earphone positive</td> </tr> </tbody> </table>	Pin	Function	1	Mic ground	2	Mic positive	3	Earphone ground	4	Earphone positive		
	Pin	Function											
	1	Mic ground											
	2	Mic positive											
	3	Earphone ground											
	4	Earphone positive											
	<b>Table 2-32: 4-pin headset socket pin out</b>												
	<table border="1"> <thead> <tr> <th>Pin</th> <th>Function</th> </tr> </thead> <tbody> <tr> <td>1</td> <td>Mic ground</td> </tr> <tr> <td>2</td> <td>Mic positive</td> </tr> <tr> <td>3</td> <td>Earphone ground</td> </tr> <tr> <td>4</td> <td>Earphone right</td> </tr> <tr> <td>5</td> <td>Earphone left</td> </tr> </tbody> </table>	Pin	Function	1	Mic ground	2	Mic positive	3	Earphone ground	4	Earphone right	5	Earphone left
	Pin	Function											
1	Mic ground												
2	Mic positive												
3	Earphone ground												
4	Earphone right												
5	Earphone left												
<b>Table 2-33: 5-pin headset socket pin out</b>													

**Table 2-34: Key to HBP-2X Beltpack connectors and controls ( base view)**



### 2.5.3 HBP-2X beltclip, beltloops and feet (base view)



Figure 2-9: HBP-2X Beltpack: base view

Key to HBP-2X Beltpack (Base view)	
Feature	Description
<b>A</b>	<b>Beltclip.</b> The beltclip is secured to the unit with three screws, and may be removed, according to your requirements.
<b>B</b>	<b>Feet (positions only).</b> The beltpack can also be placed on a level surface (once the beltclip has been removed). To give the beltpack more grip on the surface, attach the four rubber feet supplied with the beltpack.
<b>C</b>	<b>Beltloops (one either side).</b> Use to thread through a belt or strap for securing the beltpack to a belt or a fixed position.

Table 2-35: Key to HBP-2X Beltclip, beltloops and feet ( base view)

### 3 *Installing HelixNet Partyline*

---

This chapter describes how to install your HelixNet Partyline system. It also provides basic guidance on planning your installation.

**Tip:** For guidance on connecting HelixNet Partyline to other systems, using the optional interface modules, see **13 Connecting to Other Intercom Systems**.



*Do **not** plug any non-approved equipment into HelixNet Partyline.*

*HelixNet Partyline operates at different voltage levels than analog two-wire partyline systems. Do **not** plug any analog two-wire partyline equipment into the HelixNet partyline ports, as this may cause damage.*

*For more safety instructions, see **1.1 Important Safety instructions**.*

### 3.1 Planning your HelixNet Partyline installation

#### 3.1.1 Comparing digital with analog cabling

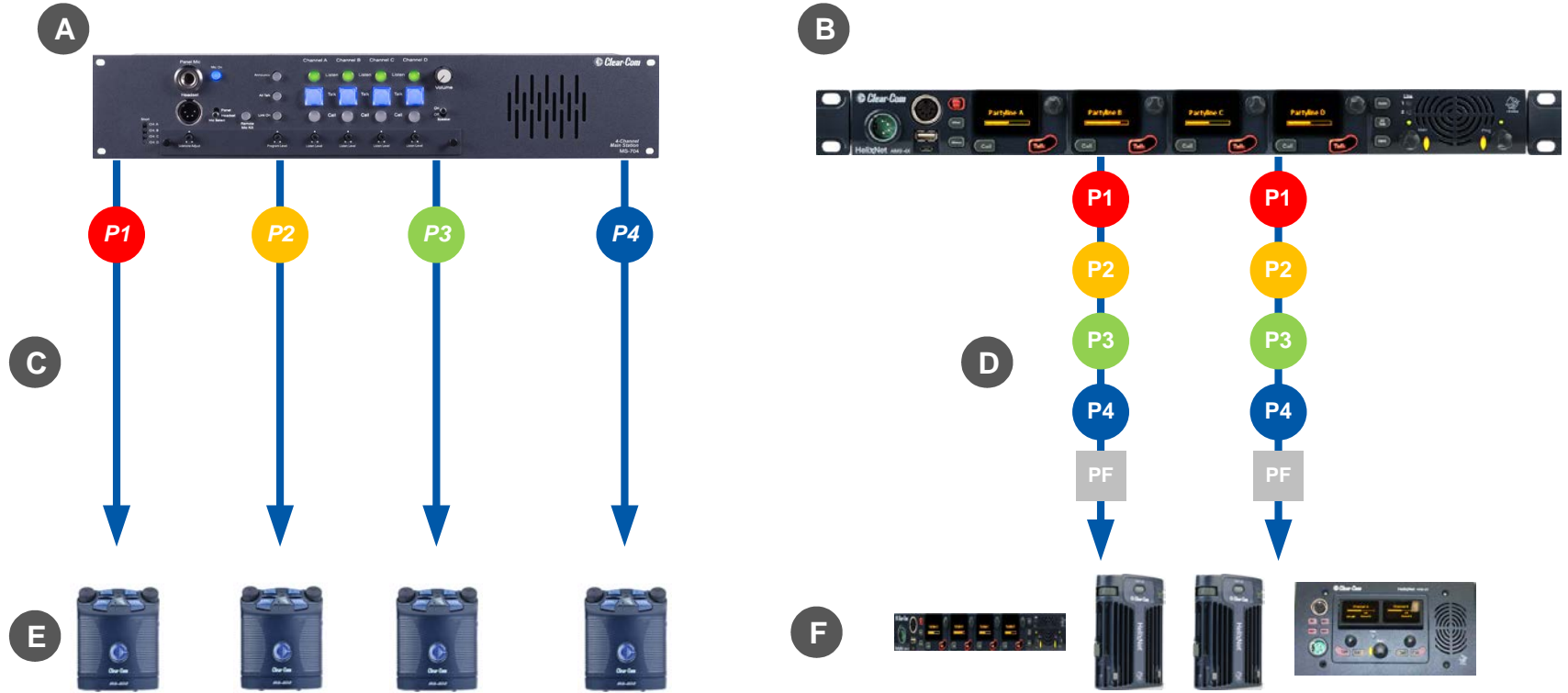

Figure 3-1: Analog and digital cabling comparison

Key to analog and digital cabling comparison diagram	
Feature	Description
<b>A</b>	Example 4-channel analog main station (MS-704 shown).
<b>B</b>	HMS-4X Main Station (digital main station).
<b>P1</b> <b>P2</b> <b>P3</b> <b>P4</b> <b>PF</b>	Partyline channel 1 Partyline channel 2 Partyline channel 3 Partyline channel 4 Program Feed
<b>C</b>	In a traditional analog partyline system, one cable is dedicated to each partyline channel. This can make it more difficult to build redundancy or spare capacity into the installation (owing to the number of connectors / cables dedicated to the delivery of channels).
<b>D</b>	In the HelixNet system, one cable can carry multiple channels. Because one cable can carry all channels, the second connector for each line can either be used for redundancy (flybacks) or for future extensions / changes to the cabling topology (layout).
<b>E</b>	Example analog partyline devices including RS-701 beltpacks. Analog beltpacks must be re-cabled to use alternative channels, requiring the physical re-location of cabling for new configurations. To aid switching, Clear-Com sells additional switching equipment (the SB-704 and RCS-2700 devices). The RS-702 (6-pin XLR) beltpack requires the YC-36 splitter / combiner to combine 2 channels into a 6-pin configuration, and multi-conductor cables. The RS-703 (3-pin XLR) beltpack requires a TWC-701 device to combine 2 Clear-Com channels in a single twisted pair.
<b>F</b>	Example analog partyline devices including HBP-2X Beltpacks. Digital beltpacks can support any two of the partyline channels (plus Program Feed), wherever they are physically located on the system. New configurations of beltpacks and channels can be deployed without the physical relocation of assets.

**Table 3-1: Key to analog and digital cabling comparison diagram**

**Note:** The capabilities of different cable types may impact how far away beltpacks can be placed from the main station, and the topologies you use. For more information about cabling, see **17 Cabling reference**.

### 3.1.2 Topologies

HelixNet Partyline can be deployed using a wide range of topologies, both complex and straightforward. The following table describes three standard types of topology:

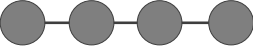
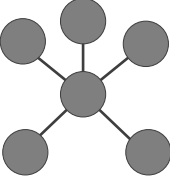
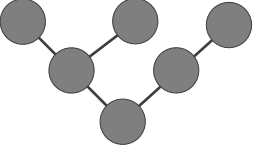
Topology	Description
<p>Daisy-chain</p> 	<p>In a daisy-chain topology, the main station is connected to the first unit. The units are then connected in a series, using the pass-through connector on the back / rear of the device to pass on the connection. No termination is required.</p> <p>Daisy-chains can be either linear or loop back to the main station to form a ring for redundancy.</p>
<p>Star</p> 	<p>In a star topology, the main station is connected to a passive (Y) splitter such as an XLR Bulkhead or Mult-box. The units are then connected to the splitter point-to-point.</p>
<p>Tree</p> 	<p>A tree topology is a more complex version of the star topology, using serially connected passive ( Y ) splitters. The units are connected to each splitter point-to-point (forming a branch of the tree).</p>

**Table 3-2: Topology types**

**Note:** If you change the network topology between any two stations, you must reboot the stations.

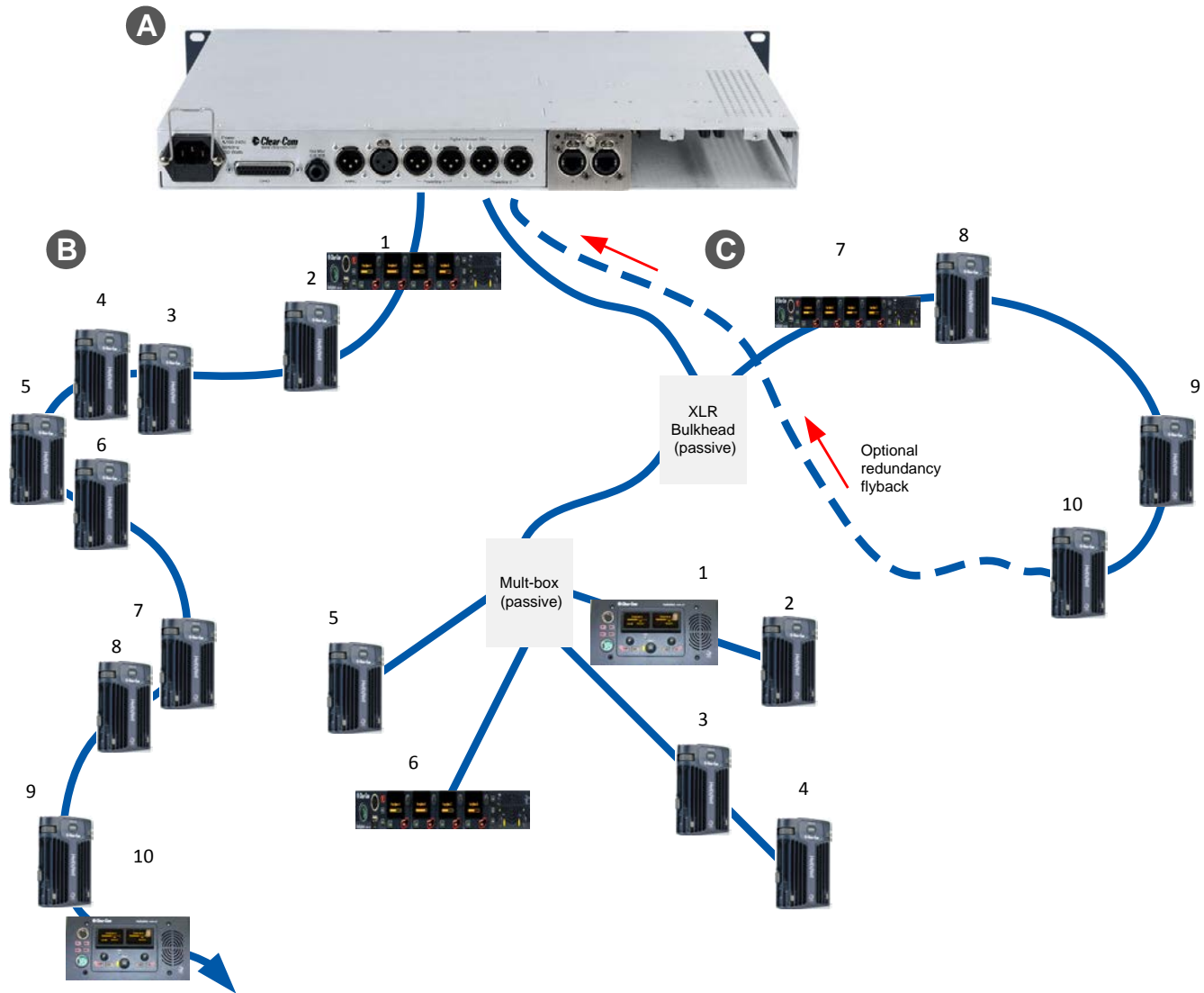

Figure 3-2: Example system topologies (layouts)

Key to example system topologies (layouts) diagram	
Feature	Description
<b>A</b>	<p>HMS-4X Main Station (digital main station) (rear panel).</p> <p>There are two lines (digital partylines) on the main station, each of which can support up to 10 digital HBP-2X beltacks. There are two connectors (3-pin XLR, male and female) for each line.</p>
<b>B</b>	<p>Daisy chained HBP-2X Beltacks. To create a 'daisy chain' of connected beltacks:</p> <p>Connect the first beltack to the main station, using either of the 3-pin XLR connectors (female or male) on the base of the beltack.</p> <p>Pass on the connection to the second beltack, using the remaining connector as the pass through.</p> <p>Repeat for all beltacks (up to 10) in the chain. No cable termination is required.</p>
<b>C</b>	<p>The second layout uses an XLR Bulkhead and a Mult-box (passive (Y) splitters) to combine:</p> <p>A daisy chain (with optional redundancy flyback).</p> <p>Point-to-point connected beltacks (using the Mult-box).</p> <p>The complexity and variety of layouts does not restrict physical access to channels.</p> <p>Because HelixNet Partyline is a digital system, the HelixNet Stations can access any of the available channels (plus a Program Feed), however they are connected to the main station (see <i>Figure 3-1: Analog and digital cabling comparison</i>).</p>

**Table 3-3: Key to example topologies (layouts)**

## 3.2 Installing the Main Station/Remote Station

The Main Station/Remote station is a **19" 1RU-height** device that you can install to either:

- A standard 19" rack.
- A shelf, cabinet or other flat surface.

### 3.2.1 Main Station power up

There is no power switch, button or key on the Main Station. To power up the unit:

- 1) Connect the power cord to the power supply connector on the Main Station.  
**Note:** The Main Station has a cable retaining clip to secure the power cord. The retaining clip is detached for shipping and must be refitted.  
**Note:** For the location of the power supply connector, see **A** in **Table 2-12: Key to HMS-4X Main Station rear panel diagram** and **Table 2-22: Key to Remote Station rear panel diagram**.
- 2) Connect the power cord to the power source. The unit requires an input voltage between 100 - 240 VAC / 50-60Hz/ 250 watts / T 3.15A H 250 V.



*Only connect power supply to earthed supply sockets. Ensure that the power supply is routed to avoid sharp bends, hot surfaces, pinches and abrasion.*

*For safety guidance, see the **Safety Instructions** at the front of this guide.*

### 3.2.2 Remote Station power up

The Remote Station is powered by an external power source. This can be:

- An external power supply (supplied)
- Power over Ethernet (PoE)  
**Note:** To use PoE, you must connect a third-party PoE switch between the Remote Station and the Main Station.
- From the Main Station power line

## 3.3 Installing the Speaker Station

The Speaker station can be installed either:

- Mounted in an S-Mount bracket for desktop use
- Mounted in an S-Mount bracket for installation on a wall
- Mounted inside a NEMA standard 4-gang wallbox.

**Note:** The S-Mount bracket is an optional item ordered separately.



### 3.3.1 Speaker Station in an S-Mount bracket



**Figure 3-3 Speaker Station in S-Mount bracket**

You can adjust the S-Mount bracket by pressing one of the release buttons on either side of the bracket. You can adjust the bracket in 10-degree steps from 80 degrees to horizontal. Indicators are present beside the release buttons that show the adjustment steps.

To install the Speaker Station:

- 1) Connect a powerline XLR-3 port on the Speaker Station to a powerline XLR-3 port on a Main Station.

**Or**

Connect an Ethernet port on the Speaker Station to an Ethernet port on an HMS-4X HLI-ET2 option module.

- 2) Connect a headset or microphone to the Speaker Station.
- 3) Connect power supply to the DC power port on the Speaker Station. (Not necessary if using Powerline or PoE.)

### 3.3.2 Speaker Station in an S-Mount bracket wall installation

When the Speaker Station is fully closed, you can mount it on a wall using the rear keyholes:

- 1) Space the wall screws to match the distance between the rear keyholes. See Figure 3-4.
- 2) If necessary, remove the Speaker Station from the S-Mount bracket.

- 3) Hang the S-Mount bracket on the wall screws.
- 4) Tighten the wall screws.
- 5) Install the Speaker Station.



Figure 3-4 S-Mount bracket with keyholes

### 3.3.3 Speaker Station mounted inside a NEMA standard 4-gang wallbox

To connect the Speaker Station:

- 1) Connect the Digital Intercom screw terminals on the Speaker Station to a powerline XLR-3 port on an HMS-4X.

**Or**

Connect an Ethernet port on the Speaker Station to an Ethernet port on an HMS-4X HLI-ET2 option module. External switches including PoE switches can be used.

- 2) Connect a headset or microphone to the Speaker Station.
- 3) If required, remove the connector from the optional power supply and connect the power supply to the Power screw terminals on the Speaker Station.

## 3.4 Installing the HBP-2X Beltpacks

The HBP-2X Beltpack is a device that you can:

- Wear at your belt using the beltclip.
- Install to a shelf or other flat surface.
- Attach to a pole or other fixed upright position.

For more information, see **2.5.3 HBP-2X beltclip, beltloops and feet (base view)**

### 3.4.1 Power up

The HBP-2X Beltpack is powered from the standard mic cable that connects the device with the HMS-4X Main Station (see below).

### 3.4.2 Connecting the HBP-2X Beltpack to the Main Station

To connect the HBP-2X Beltpack to the Main Station:

- 1) There are two partylines on the Main Station which can each support up to 10 digital HBP-2X beltpacks. There are two connectors (3-pin XLR, male and female) for each line.

Connect the cable to the selected connector on the Main Station.

**Note:** For the location of Lines 1 and 2 (the powerlines) on the Main Station, see **F** **G** in **Figure 2-3: HMS-4X Main Station: rear panel**

- 2) Connect the cable to the beltpack, using one of the two 3-pin XLR connectors (male and female) on the base / rear of the beltpack.

For example topologies, see **3.1.2 Topologies**.

## 4 Configuring and managing the Main Station

---

This chapter describes how to configure the settings and manage the Main Station using **Menu mode**. It also shows you how to monitor and diagnose performance issues, using the **Diagnostics** menus.

**Tip:** For a quick reference to the Main Station menus, see **16 Menu maps**.

### 4.1 Using the Menus

To place the main station in **Menu mode**, press the **Menu key** to the left of the first display screen.

In Menu mode, the display screens display the four levels of menu. The menu hierarchy proceeds left to right:

- The **top level** menu is presented in the first screen.
- The **lowest level** menu is presented in the fourth screen (furthest right on the front panel).

#### 4.1.1 Configuring settings

To configure settings:

- 1) For each menu, turn the **rotary control** clockwise to scroll down the menu items. Turn counter clockwise to scroll up the menu items.

Off-screen menu items are indicated by arrows at the top and/or bottom of the screen.

**Selected menu items** (which create your path through the four menus) are highlighted in solid yellow.

The fourth menu displays the settings that relate to your previous menu choices (system features or functionality).

The **current setting** is indicated by a dotted box around the menu item

- 2) When you have selected a setting by rotating the right hand rotary control, press that **rotary control** to enable the setting on the main station.

#### 4.1.2 Exiting Menu mode

To exit menu mode press the menu key.

**Note:** If no key is pressed for 20 seconds, the menu will time out and display screens will revert to their normal mode of operation

## 4.2 Configuring the Audio settings

### 4.2.1 Audio settings for the headset

To configure the audio settings for the headset:

- 1) In **Menu mode**, select **Audio Settings** and then **Headset**.
- 2) To adjust the level of sidetone on the headset:
  - a) In the third menu, select **Sidetone Gain**.
  - b) In the fourth menu, select one of the following:
    - 0dB
    - - 6dB
    - - 12dB (default)
    - - 18dB
  - c) To enable (confirm) the selected setting, press the **rotary control**.
- 3) To limit the audio level delivered to the headphones (or to disable headphone limiting):
  - a) In the third menu, select **Headphone Limit**.
  - b) In the fourth menu, select one of the following:
    - Off
    - +6dB
    - 0dB (default)
    - - 6dB
  - c) To confirm the selected setting, press the **rotary control**.

**Note:** When Headphone Limit is set to anything but Off, a LIM indication will be shown on the leftmost display.

- 4) To set (or disable) sidetone tracking on the headset:
  - a) In the third menu, select **Sidetone Control**.
  - b) In the fourth menu, select one of the following:
    - **Tracking** - The sidetone volume will follow (track) the Main volume level.
    - **Non-Tracking** - The sidetone volume is set to maximum.
    - **Disabled** - Sidetone is disabled.

**Note:** The default is **Tracking**.

- c) To confirm the selected setting, press the **rotary control**.

- 5) To select the type of microphone on the headset:
  - a) In the third menu, select **HS Mic Type**.

**Note:** **HS** = Headset.

  - b) In the fourth menu, select either of the following types of microphone:
    - Electret (-15dB)
    - Dynamic (0dB) (default)
    - Dynamic (-10 dB)
  - c) To confirm the selected setting, press the **rotary control**.

## 4.2.2 Audio settings for the microphone

To configure the audio settings for the microphone:

- 1) In Menu mode, select **Audio Settings** and then **Microphone**.
- 2) To select the Headroom:
  - a) From the third menu, select **Headroom**.
  - b) From the fourth menu, select one of the following:
    - Normal (default)
    - High - Reduces the analog input gain and increases the digital gain accordingly. That reduces digital clipping at the A/D converter but increases the noise floor. This setting is intended for use in environments with very high background noise.
- 3) To enable or disable the Contour Filter:
  - a) From the third menu, select **Contour Filter**
  - b) From the fourth menu, select one of the following:
    - **Enabled** - The Contour filter is a Clear-Com algorithm enhancing speech intelligibility, especially when whispering or talking at a low volume.
    - **Disabled**

**Note:** The default is **Enabled**.

## 4.2.3 Audio setting for the Program Input

To configure the audio setting for the Program Input (Program Feed) gain:

- 1) In **Menu mode**, select **Audio Settings** and then **Program Input**.
- 2) From the third menu, select **Gain**.

- 3) From the fourth menu, select one of the following:
  - + 12dB
  - + 6dB
  - 0dB (default)
  - - 6dB
  - - 12dB

- 4) To confirm the selected setting, press the **rotary control**.

The GPO trigger activates a relay when receiving a call or activating a talk on a partyline channel. You can enable or disable the GPO trigger. To configure the audio setting for the GPO trigger:

- 1) In **Menu mode**, select **Audio Settings** and then **Program Input**.
- 2) From the third menu, select **GPO Trigger**.
- 3) From the fourth menu, select one of the following:
  - Enabled (default)
  - Disabled
- 4) To confirm the selected setting, press the **rotary control**.

**Note:** You can also configure the GPO trigger using **Menu Mode > Modules Settings**.

To select the VOX:

- 1) From the third menu, select **VOX**.
  - a) From the fourth menu, select one of the following:
    - Enabled
    - Disabled (default)
- 2) To confirm the selected setting, press the **rotary control**.

To select the VOX Off Delay:

- 1) From the third menu, select **VOX Off Delay**.
- 2) From the fourth menus, select one of the following:
  - .5 sec (default)
  - 1 sec
  - 2 sec
  - 3 sec
  - 4 sec

- 3) To confirm the selected setting, press the **rotary control**.

#### 4.2.4 Audio settings for Program IFB [*Interruptible Foldback*]

IFB allows you to temporarily interrupt the continuous program listen (program feed) and speak to the channels connected to the program listen. See also **4.4.2 Assigning the Program Listen to a channel**.

To configure the audio settings for Program IFB [*Interruptible Foldback*]:

- 1) In **Menu mode**, select **Audio Settings** and then **Program IFB**.
- 2) From the third menu, select **IFB Dim Level**.  
**Note:** The IFB Dim Level determines the amount that the volume level of the Program Level is reduced by when it is interrupted by the IFB.
- 3) From the fourth menu (fourth display screen), select one of the following:
  - IFB Disabled (default)
  - - 6dB
  - -12dB
  - -18dB
  - -24dB
  - Full Cut
- 4) To confirm the selected setting, press the **rotary control**.

#### 4.2.5 Audio settings for the SA [*Stage Announce*] Output

To configure the audio settings for the SA [*Stage Announce*] Output:

- 1) In **Menu mode**, select **Audio Settings** and then **SA Output**.
- 2) From the third menu, select **Gain**.
- 3) From the fourth menu, select one of the following:
  - + 12dB
  - + 6dB
  - 0dB (default)
  - - 6dB
  - - 12dB
- 4) To confirm the selected setting, press the **rotary control**.



## 4.2.6 Audio settings for the Hot Mic Output

To configure the audio settings for the Hot Mic Output:

- 1) In **Menu mode**, select **Audio Settings** and then **Hot Mic Output**.
- 2) From the third menu, select **Gain**.
- 3) From the fourth menu, select one of the following:
  - + 12dB
  - + 6dB
  - 0dB (default)
  - - 6dB
  - -12dB
- 4) To confirm the selected setting, press the **rotary control**.

## 4.2.7 Audio settings for the Front Panel

To configure the audio settings for the Front Panel:

- 1) In **Menu mode**, select **Audio Settings** and then **Front Panel**.
- 2) From the third menu, select **Loudspeaker Dim**.
- 3) From the fourth menu, select one of the following:
  - 0 dB
  - -3 dB
  - -6 dB (default)
  - -12 dB
  - -24 dB
- 4) To confirm the selected setting, press the **rotary control**.

## 4.3 Selecting Station Settings

### 4.3.1 Setting Preferences

To set the **Preferences**:

- 1) In **Menu mode**, select **Station Settings** and then **Preferences**.
- 2) From the third menu, select **Station ID**, and enter a station ID with a maximum of 10 alphanumeric characters. For information about entering characters, see **4.4.1 Editing the channel label**.
- 3) To confirm the selected setting, press the **rotary control**.

### 4.3.2 Setting Keypad Assignments

To set the **Keypad Assignments**:

- 1) In Menu mode, select Station Settings and then **Keypad Assign**.
- 2) From the third menu, select **Keypad 1**.
- 3) From the fourth menu, select a name to assign to the Keypad.
- 4) Repeat this procedure for the remaining Keypads.
- 5) To confirm the selected setting, press the **rotary control**.

### 4.3.3 Setting key latching

To enable or disable front panel keys for latching:

- 1) In **Menu mode**, select **Station Settings** and then **Keypads**.
- 2) From the third menu, select either:

Key(s)	Description
Talk Latch #1	Talk keys for the four available channels.
Talk Latch #2	
Talk Latch #3	
Talk Latch #4	
SA Output key	Key used to talk to a connected public address or Stage Announce (SA) system.

**Table 4-1: Setting key latching**

**Note:** The **RMK (Remote Mic Kill)** key is also displayed in the list. This key **cannot** be latched. To find out how to enable or disable the RMK key, see **4.3.4 Setting the RMK (Remote Mic Kill) key**.

**Tip:** For a quick reference to the location of keys on the front panel, see **2.1 Main Station/Remote Station: Front panel**.

- 3) From the fourth menu, select **either** of the following:
  - Latching
  - Non-latching

**Note:** The default for Talk Latch for the four available channels is Latching. The default for the SA Output key is Non-latching.

- 4) To confirm the selected setting, press the **rotary control**.

#### 4.3.4 Setting the RMK (Remote Mic Kill) key

The RMK (Remote Mic Kill) key is used to:

- Deselect any latched keyset Talk routes.
- Turn off any latched Talk on connected analog partyline equipment.

To enable or disable the RMK (Remote Mic Kill) key:

- 1) In **Menu mode**, select **Station Settings** and then **Keysets**.
- 2) From the third menu, select **RMK**.

**Note:** *Talk Latch and the SA Output Key are also listed in this menu. See 4.3 Selecting Station Settings.*

- 3) From the fourth menu, select **either** of the following:
  - Enabled (default)
  - Disabled

- 4) To confirm the selected setting, press the **rotary control**.

#### 4.3.5 Setting display screen brightness

By default, the display screens are set for **medium** brightness. To set the brightness of the display screens:

- 1) In **Menu mode**, select **Station Settings** and then **Display**.
- 2) From the third menu, select **OLED Brightness**.
- 3) From the fourth menu, select one of the following brightness settings:
  - High
  - Medium (default)
  - Low

- 4) To confirm the selected setting, press the **rotary control**.

### 4.3.6 Setting key brightness

By default, the front panel keys are set to **High / Low**. To set the brightness of all front panel keys:

- 1) In **Menu mode**, select **Station Settings** and then **Display**.
- 2) From the third menu, select **Key Brightness**.
- 3) From the fourth menu, select one of the following brightness settings:

Key(s)	Description
High / Low	The default setting. Keys are lit bright when active and lit dim when inactive.
High / Off	Keys are lit bright when active and are unlit when inactive.
Low / Off	Keys are lit dim when active and are unlit when inactive.
Off / Off	Keys are unlit, whether or not they are active or inactive.

**Table 4-2: Setting key brightness**

- 4) To confirm the selected setting, press the **rotary control**.

### 4.3.7 Setting the screensaver

The screensaver features the channel label and is enabled by default. The display screens enter screensaver mode when the main station has been inactive for 10 minutes.

**Tip:** To exit screensaver mode, press any key on the front panel.

To enable or disable the screensaver:

- 1) In **Menu mode**, select **Station Settings** and then **Display**.
- 2) From the third menu, select **Screensaver**.
- 3) From the fourth menu, select either:
  - **Enabled** (default)
  - **Disabled**
- 4) To confirm the selected setting, press the **rotary control**.

## 4.4 Configuring the channel settings

### 4.4.1 Editing the channel label

The maximum length for a channel label is **10 characters**. See **8.1.6 Resource Sharing between Linked Stations** for an explanation of how identical labels are treated when Main Stations are linked. To edit the channel label:

- 1) In **Menu mode**, select **Channels** and then the name of the channel you want to edit.
- 2) From the third menu, select **Label**.
- 3) Select **Clear** and press the rotary control to clear the channel label.
- 4) In the fourth menu, the following prompt is displayed above the channel label:

[Press to edit]

Press the **rotary control**.

- 5) The first letter of the channel label is shown as selected. The following prompt is displayed above the channel label:

[Scroll / Press to Select]

Scroll to the character you want to edit by turning the **rotary control**. To begin editing, press the **rotary control**.

- 6) The character you have selected for editing is shown in a box with a dotted border. To display alternative characters in the box, turn the rotary control. The range of available characters comprises the following:

Characters	Description / range
Numbers (numeric)	0 to 9
Letters	Capital letters = A to Z Small letters = a to z
Symbols	# & * ( ) - _ = + / ! @ : <b>Note:</b> You can also select a space.

**Table 4-3: Channel label characters**

To select a character, press the **rotary control**.

- 7) When you have selected a replacement character, scroll to the next character you want to edit. When you have finished editing the channel label, scroll to **Save** (displayed beneath the channel label).

To save the channel label, press the **rotary control**.

## 4.4.2 Assigning the Program Listen to a channel

To assign (or unassign) the Program Listen (Program Feed) to a channel:

- 1) In **Menu mode**, select **Channels** and then the name of the channel.
- 2) From the third menu, select **Program Listen**.
- 3) From the fourth menu, select either **None**, or choose from the list of available programs.

**Note:** The default is **None**.

- 4) To confirm the selected setting, press the **rotary control**.

**Tip:** When you assign the Program Listen to a channel, **PGM** is displayed on the display screen (under the listen level bar, to the left) for that channel.

## 4.4.3 Assigning a GPO relay to a channel

You can assign a relay that is triggered on receiving a call or detecting a talk on a partyline channel. To assign (or unassign) a relay:

- 1) In **Menu mode**, select **Channels** and then the name of the channel.
- 2) From the third menu, select **GPO on Talk** or **GPO on Call**.
- 3) From the fourth menu, select either **None**, or choose from the list of available relays.

**Note:** The default is **None**.

- 4) To confirm the selected setting, press the **rotary control**.

## 4.5 Configuring the Control I/O

The Control I/O connector (25 way female D-type) on the rear panel allows you to connect up to 4 relay outputs or 4 opto inputs and control them through the main station keysets:

I/O type	Description
Opto inputs	Opto inputs enable you to connect a foot switch or other control device and use it to trigger Call or Talk functions.
Relay outputs	Relay outputs enable you to use Call or Talk keys to trigger any external device that accepts a standard contact closure (such as a theater curtain or an On Air light).

Table 4-4: Opto inputs and Relay outputs

### 4.5.1 Configuring Opto inputs

To configure the Control I/O for Opto inputs:

- 1) In **Menu mode**, select **Control I/O**.
- 2) From the second menu, select **Inputs**.
- 3) From the third menu, select one of the following:
  - Opto 1
  - Opto 2
  - Opto 3
  - Opto 4
- 4) From the fourth menu (fourth display screen), select one of the following:
  - None
  - Call Key 1
  - Talk Key 1
  - Call Key 2
  - Talk Key 2
  - Call Key 3
  - Talk Key 3
  - Call Key 4
  - Talk Key 4
- 5) To confirm the selected setting, press the **rotary control**.

## 4.5.2 Configuring Relay outputs

To configure the Control I/O for Relay outputs:

- 1) In **Menu mode**, select **Control I/O**.
- 2) From the second menu, select **Outputs**.
- 3) From the third menu, select one of the four available Relay outputs:
  - Relay 1
  - Relay 2
  - Relay 3
  - Relay 4

- 4) From the fourth menu, select one of the following:
  - None (default)
  - Call Key 1
  - Talk Key 1
  - Call Key 2
  - Talk Key 2
  - Call Key 3
  - Talk Key 3
  - Call Key 4
  - Talk Key 4
  - SA Key

**Note:** The number of the key relates to the keyset to which it belongs (for example, Call Key 1 is the Call key for the first keyset / display screen).

- 5) To confirm the selected setting, press the **rotary control**.



## 4.6 Configuring Module Settings

Up to three optional interface modules can be fitted to the expansion bay of the HMS-4X Main Station.

**Warning:** The interface modules are not hot pluggable. Ensure that the Main Station is powered down before inserting or removing modules.

The **Menu mode > Module Settings** are used to set up the interface modules.

**Tip:** For more detailed information about interface modules, including pin out information, see: **2.2.1 HMS-4X Main Station rear panel: Interface modules.**

### 4.6.1 Configuring a Four-wire interface module

The following procedure shows you how to configure the Module Settings for a **Four-wire interface module**.

To configure the Module Settings for a four-wire interface module:

- 1) In **Menu mode**, select **Module Settings**.
- 2) From the second menu, select one of the two available ports on the two-wire interface module:  
`Slot 2/Port A 4W`  
`Slot 2/Port B 4W`  
**Note:** In this example, the four-wire module has been fitted to slot 2 in the expansion bay. The expansion bay contains three slots.  
**4W** = four-wire.
- 3) To associate one of the four available channels with the selected port, or to disable channels associations:
  - a) From the third menu, select **Channel Assign**.
  - b) From the fourth menu, select one of the following:
    - Disabled (default)
    - Channel A.
    - Channel B.
    - Channel C.
    - Channel D.

**Note:** When linking is enabled, there will be more than four channels.

- c) To confirm the selected setting, press the **rotary control**.

- 4) The Program Output allows a program feed associated with the channel assigned to the four wire port to either be delivered to that 4 wire port alongside the other channel audio or not. To set the Program Output:
  - a) From the third menu, select **Program Output**.
  - b) From the fourth menu, select one of the following:
    - Unmute
    - Mute (default)
- 5) To confirm the selected setting, press the **rotary control**.
- 6) To set the input level for the four-wire port:
  - a) From the third menu (third display screen), select **Input Gain**.
  - b) From the fourth menu (fourth display screen), select one of the following:
    - +12dB
    - + 6dB.
    - 0dB (default)
    - -6dB.
    - -12dB
  - c) To confirm the selected setting, press the **rotary control**.
- 7) To set the output level for the four-wire port:
  - a) From the third menu, select **Output Gain**.
  - b) From the fourth menu, select one of the following:
    - +12dB
    - + 6dB.
    - 0dB (default)
    - -6dB.
    - -12dB
- 8) To confirm the selected setting, press the **rotary control**.

- 9) If you are setting up a continuous audio (program) feed using the four-wire interface module, then you may want to enable the **VOX functionality**. To help reduce redundant noise, the VOX functionality automatically deactivates and activates the continuous audio feed, at an automatically determined volume threshold.

**Note:** If you assign a program and a four-wire interface to the same channel, VOX is automatically enabled.

To enable or disable VOX:

- a) From the third menu, select **VOX**.
  - b) From the fourth menu, select one of the following:
    - Enabled.
    - Disabled (default)
  - c) To confirm the selected setting, press the **rotary control**.
- 10) The **VOX Delay OFF** setting determines the length of time to wait before deactivating the incoming audio. To set the VOX Delay OFF setting:
- a) From the third menu, select **VOX Delay OFF**.
  - b) From the fourth menu, select one of the following:
    - .5 sec (default)
    - 1 sec
    - 2 sec
    - 3 sec
    - 4 sec
  - c) To confirm the selected setting, press the **rotary control**.

## 4.6.2 Configuring a Two-wire interface module

The following procedure shows you how to configure the Module Settings for a **Two-wire interface module**.

**Note:** The Two-wire interface module must receive power from the partyline.

To configure the Module Settings for a Two-wire interface module:

- 1) In **Menu mode**, select **Module Settings**.

- 2) From the second menu, select one of the two available ports on the two-wire interface module:

Slot 1/Port A 2W

Slot 1/Port B 2W

**Note:** In this example, the two-wire module has been fitted to slot 1 in the expansion bay. The expansion bay contains three slots.

**2W** = Two-wire.

- a) To associate one of the four available channels (or to disable channels associations) with the selected port:

From the third menu (third display screen), select **Channel Assign**.

- b) From the fourth menu, select one of the following:

- Disabled (default)
- Channel A
- Channel B
- Channel C
- Channel D

**Note:** When linking is enabled, there will be more than four channels.

- c) To confirm the selected setting, press the **rotary control**.

- 3) The Program Output allows a program feed associated with the channel assigned to the four wire port to either be delivered to that 4 wire port alongside the other channel audio or not. To set the Program Output:

- a) From the third menu, select **Program Output**.

- b) From the fourth menu, select one of the following:

- Unmute (default)
- Mute

- 4) To confirm the selected setting, press the **rotary control**.

- 5) **Auto-nulling** helps to reduce echo while talking on a two-wire audio system. To start Auto-nulling on the selected port:

- a) From the third menu, select **Auto-Nulling**.

- b) From the fourth menu, select **Start**.

**Note:** Auto-nulling is only applicable to two-wire audio. **All** Talk routes/keys must be **disabled** before Auto-nulling can commence. If an echo persists, ensure all Talk routes are disabled and re-null the system.

- 6) The Two-wire interface module is set for Clear-Com systems by default. However, you can also set the two-wire ports for use with RTS analog partyline systems. If you are connecting to an **RTS** system, you also have a choice of two different pinouts:

RTS pinout option	Description
RTS Audio Pin 2	Pin 2 is used for both power and audio.
RTS Audio Pin 3	Pin 3 is used for audio (Pin 2 is used for power only).

**Table 4-5: Configuring Module Settings: RTS pinout options**

**Note:** For detailed pinout information, see **2.2.1 HMS-4X Main Station rear panel: Interface modules**.

To configure the port for either Clear-Com or RTS systems:

- a) From the third menu, select **Mode**.
  - b) From the fourth menu, select one of the following:
    - Clear-Com
    - RTS Audio Pin 2
    - RTS Audio Pin 3
  - c) To confirm the selected setting, press the **rotary control**.
- 7) To set the **Input Gain**:
- From the third menu, select **Input Gain**.
- From the fourth menu, select one of the following:
- +3 dB
  - +2 dB
  - +1 dB
  - 0 dB (default)
  - -1 dB
  - -2 dB
  - -3 dB

- 8) To set the **Output Gain**:
- a) From the third menu, select **Output Gain**.
  - b) From the fourth menu, select one of the following:
    - +3 dB
    - +2 dB
    - +1 dB
    - 0 dB (default)
    - -1 dB
    - -2 dB
    - -3 dB

- 9) Enabling **RMK [Remote Mic Kill] Input** allows an external source such as the main (base) station of the connected two-wire system to send an RMK signal to the analog beltpacks attached to the HelixNet main station.

**Note:** If this is enabled and the analog party line system is powered down, it will be interpreted by the HelixNet Main Station as an RMK input and all talk routes will be switched off.

To enable RMK Input:

- a) From the third menu (third display screen), select **RMK Input**.
  - b) From the fourth menu (fourth display screen), select one of the following:
    - Enabled
    - Disabled (default)
  - c) To confirm the selected setting, press the **rotary control**.
- 10) Enabling **RMK [Remote Mic Kill] Output** allows you to send an RMK signal from the HelixNet main station to the connected analog beltpacks.

To enable RMK Output:

- a) From the third menu, select **RMK Output**.
- b) From the fourth menu, select one of the following:
  - Enabled
  - Disabled (default)

To confirm the selected setting, press the **rotary control**.

- 11) If you are setting up a continuous audio (program) feed using the two-wire interface module, then you may want to enable the **VOX functionality**. To help reduce redundant noise, the VOX functionality automatically deactivates and activates the continuous audio feed, at an automatically determined volume threshold.

**Note:** If you assign a program and a two-wire interface to the same channel, VOX is automatically enabled.

To enable or disable VOX:

- a) From the third menu, select **VOX**.
  - b) From the fourth menu, select one of the following:
    - Enabled
    - Disabled (default)
  - c) To confirm the selected setting, press the **rotary control**.
- 12) The **VOX Delay OFF** setting determines the length of time to wait before deactivating the incoming audio. To set the VOX Delay OFF setting:
- a) From the third menu, select **VOX Delay OFF**.
  - b) From the fourth menu, select one of the following:
    - .5 sec (default)
    - 1 sec
    - 2 sec
    - 3 sec
    - 4 sec
  - c) To confirm the selected setting, press the **rotary control**.

### 4.6.3 Configuring an Ethernet or Fiber interface module

The following procedure shows you how to configure the Module Settings for an **Ethernet interface module**.

To configure the Module Settings for an Ethernet interface module:

- 1) To view status information about Main Stations:
  - a) In **Menu mode**, select **Networking**.

**Note:** The Networking menu only appears if at least one Ethernet or Fiber interface module is detected.

  - b) From the second menu, select **Stations**. A list of station IDs is given for each Main Station in the network. Each station ID in the list is preceded by the letter L- for the Local station itself and R- for all remote stations.
  - c) From the third menu select the required station ID.
  - d) From the fourth menu you can view the following:
    - **Status** – Enabled or Disabled
    - **IP** – The IP address.
- 2) To enable or disable linking:
  - a) In **Menu mode**, select **Networking**.

**Note:** The Networking menu only appears if an Ethernet or Fiber interface module is detected.

  - b) From the second menu, select **Linking**.

- c) From the third menu, select **Link Station**.
  - d) From the fourth display screen, select one of the following:
    - Disabled (default)
    - Enabled
- 3) To enable or disable DHCP:
- a) In **Menu mode**, select **Networking**.
- Note:** The Networking menu only appears if an Ethernet or Fiber interface module is detected.
- b) From the second menu, select **Preferences**.
  - c) From the third menu, select **DHCP**.
  - d) From the fourth display screen, select one of the following:
    - Disabled
    - Enabled (default)
- 4) To edit the IP address:
- a) In **Menu mode**, select **Networking**.
- Note:** The Networking menu only appears if an Ethernet or Fiber interface module is detected.
- b) From the second menu, select **Preferences**.
  - c) From the third menu, select **IP Address**.
  - d) From the fourth display screen, edit the IPv4 address.
- Note:** You can only edit the IPv4 address if DHCP is disabled.
- Note:** The HelixNet system uses a 10.0.0.x IP address range internally between the Main Station and the Beltpacks, and therefore will not allow setting the external IP address to anything in that range.
- Note:** If you change the IP address (either manually or through DHCP), the link between stations will be broken and you have to reboot the Main Station to link again. The following message will appear as a banner (inverted text) at the bottom across the four displays on the Main Station  
IP address | changed, | reboot | to link  
If that message appears, pressing the Menu key will bring you directly to:  
**Administration->Reset->Reboot->Reboot Now**
- 5) To edit the Gateway:
- a) In **Menu mode**, select **Networking**.
- Note:** The Networking menu only appears if an Ethernet or Fiber interface module is detected.
- b) From the second menu, select **Preferences**.
  - c) From the third menu, select **Gateway**.



d) From the fourth display screen, edit the gateway.

**Note:** You can only edit the gateway if DHCP is disabled.

6) To edit the Subnet Mask:

a) In **Menu mode**, select **Networking**.

**Note:** The Networking menu only appears if an Ethernet or Fiber interface module is detected.

b) From the second menu, select **Preferences**.

c) From the third menu, select **Subnet Mask**.

d) From the fourth display screen, edit the Subnet Mask.

**Note:** You can only edit the Subnet Mask if DHCP is disabled.

#### 4.6.4 Configuring the Module Settings: Version information

The software (firmware) for the ports on the interface module must match that on the HelixNet Main Station itself.

**Note:** Ethernet and fiber option modules do not contain software.

To check the software version for the Main Station and each port on the interface module:

1) In Menu mode, select **Administration > Software > Current**.

2) In the fourth menu, use the **rotary control** to scroll the displayed software versions.

3) The software versions for each port are listed under **Snx**, where **n** indicates the slot number, and **x** indicates port A or port B.

The software versions for the two processors in the Main Station (Main Station and IV-Router) are listed under MS and IVR respectively.

## 4.7 Administration

In **Menu mode > Administration**, you can:

- View the current versions of the software for the system.
- Update the software (firmware).
- Lock or unlock the menus on HBP-2X beltpacks, Remote Stations and Speaker Stations connected to the main station.
- Reset the Main Station to the default settings.
- Manually reboot the Main Station.
- Save and Restore the settings.

### 4.7.1 Viewing the current versions of the software

To view the current versions of the software on the Main Station, see **4.6.4 Configuring the Module Settings: Version information**.

## 4.7.2 Updating the software

Any HBP-2X beltpacks, Remote Stations and Speaker Stations that are connected to the Main Station are automatically updated. The units remain non-functional for approximately 5 minutes while they are updated.

To update the software:

- 1) After downloading the software update, copy the update to a USB memory stick.
- 2) Insert the memory stick into the USB 2.0 (A) connector. See **Table 2-3 Key to Main Station/Remote Station front panel** diagram.
- 3) In **Menu mode**, select **Administration** and then **Software**.
- 4) From the third menu, select **Update**.
- 5) The fourth menu displays the new software version information on the USB memory stick. To start updating the Main Station with the new software, press the rotary control.

The process of updating the software takes several minutes. The following system messages are displayed during the process:

```
Loading image
Erasing flash
Writing to flash
Verifying flash
Successful
```

**Note:** Do not remove the USB memory stick from the Main Station until the software update is completed, including the update to any connected devices.



Do **not** turn off the power to the Main Station during the software (firmware) update. Turning off the power can damage the device.

**Note:** The Main Station resets **automatically**. You are **not** required to restart the Main Station. To check that the software upgrade was performed successfully, see **4.7.1 Viewing the current versions of the software**.

### 4.7.3 Locking and unlocking the HBP-2X beltpack menus

You can prevent beltpack users from changing the menu settings on connected HBP-2X beltpacks by locking the menus. Unlock the beltpack menus to allow users to change the beltpack menu settings.

To lock (or unlock) the HBP-2X beltpack menus from the Main Station:

- 1) In **Menu mode**, select **Administration** and then **Beltpacks**.
- 2) The third menu displays a single, selected menu item: **Menu Lock**. In the fourth menu (fourth display screen), select either of the following:
  - Unlock All
  - Lock All
- 3) To confirm the selected setting, press the **rotary control**.

### 4.7.4 Resetting the Main Station to default (factory mode) settings.

To reset the Main Station to its default (factory mode) settings:

- 1) In **Menu mode**, select **Administration** and then **Reset**.
- 2) The third menu displays a selected menu item: **Reset to Default**.
- 3) In the fourth menu, select between:
  - Reset HMS
  - Reset HBPs
  - Reset All

*The beltpacks will receive updated (default) channel label information. All other local beltpack settings will **not** be reset if the Main Station is reset to default settings.*

## 4.7.5 Manually rebooting the Main Station

To manually reboot the Main Station:

- 1) In **Menu mode**, select **Administration** and then **Reset**.
- 2) The third menu select **Reboot**.
- 3) In the fourth menu, select **Reboot Now**.

When the **rotary control** is pressed, the display changes to **Rebooting ...** for 2 seconds, and then the Main Station reboots.

## 4.7.6 Saving and restoring the software settings.

To save or restore the software settings:

- 1) Insert a memory stick into the USB 2.0 (A) connector. See **Table 2-3 Key to Main Station/Remote Station front panel** diagram.
- 2) In **Menu mode**, select **Administration** and then **Settings**.
- 3) To save, in the third menu, select **Save**. Once you select **Save** you should not remove the USB stick right away. Depending on the USB stick it might take up to 5 seconds to complete.
  - a) In the fourth menu, select between saving to a USB or saving locally.
- 4) To restore, in the third menu, select **Restore**.
  - a) In the fourth menu, select between restoring from a USB or restoring from a list of files.

## 4.8 Diagnostics

The **Diagnostics** menus help you to monitor the performance of the Main Station and diagnose possible system issues.

### 4.8.1 Viewing hardware information

To view information about the hardware (PCBs) on the Main Station:

- 1) In **Menu mode**, select **Diagnostics** and then **Hardware**.

2) From the third menu, select one of the following:

- Main PCB
- Slot 1 PCB
- Slot 2 PCB
- Slot 3 PCB

**Note:** **Slot 1**, **Slot 2** and **Slot 3** refer to the interface module slots in the Main Station extension bay. When looking at the rear of the module, **slot 1** is the left-hand slot, **slot 2** is the middle slot, and **slot 3** is the right-hand slot.

The fourth menu displays the **Part number**, **Revision** and **Serial numbers** for the PCB. The format is similar to the following:

```
Part xxxxxx  
Revision: x  
Serial: x
```

Where **x** is a numerical value.

## 4.8.2 Viewing temperature information

To view the temperature of the Main Station:

- 1) In **Menu mode**, select **Diagnostics** and then **Hardware**.
- 2) From the third menu, select one of the following temperature sensors:
  - Sensor 1
  - Sensor 2
  - Sensor 3

The fourth menu displays the temperature, for example:

```
+30°C
```

### **Environmental note:**

The recommended operating temperature range for the HelixNet HMS-4X Main Station is **0 to +40°C**. The storage temperature range for the Main Station is **-30 to +70°C**.

For more environmental information, see **3 Installing HelixNet Partyline**.

## 4.8.3 Viewing powerline information and status

There are two digital partylines (**Line 1** and **Line 2**) on the HMS-4X Main Station. Line 1 and Line 2 are also referred to as **powerlines**.

Each line can support up to 10 HBP-2X beltpacks, Remote Stations or Speaker Stations.

**Note:** See also **F**, **G** and **I** in **Table 2-3 Key to Main Station/Remote Station front panel diagram**.

To view line information and status:

- 1) In **Menu mode**, select **Diagnostics** and then **Powerlines**.
- 2) From the third menu, select one of the following:
  - Powerline 1 (refers to Line 1)
  - Powerline 2 (refers to Line 2)
- 3) The fourth menu displays the status and other measures / information for the powerline. The status of the powerline is either **Ok** [operating normally], **Busy** or **Error**.

For more details of the information displayed, see **16 Menu maps**.

**Note:** Powerline status is also indicated by the powerline LEDS on the front panel.

**Green** LED = **OK**

**Amber** LED = **Busy**

**Red** LED = **Error**

For more information about powerline diagnostics, see **18 Troubleshooting**.

#### 4.8.4 Viewing keysets information

To view information about the keysets:

- 1) In **Menu mode**, select **Diagnostics** and then **Keysets**.
- 2) From the third menu (third display screen), select a keyset from 1 to 4.
- 3) The fourth menu (fourth display screen) displays the following status information:
  - **Name** – The channel name
  - **Talkers** – The number of talkers on the partyline
  - **Main Stations** – The number of Main Stations listening
  - **Beltpacks** – The number of beltpacks listening on the partyline
  - **Remote** – The number of Remote Stations listening
  - **Speaker** – The number of Speaker Stations listening.
  - **2-Wire** – The number of 2-wire ports listening
  - **4-Wire** – The number of 4-wire ports listening

## 5 Configuring and managing the Remote Station

---

This chapter describes how to configure the settings and manage the Remote Station using **Menu mode**. It also shows you how to monitor and diagnose performance issues, using the **Diagnostics** menus.

**Tip:** For a quick reference to the Remote Station menus, see **16 Menu maps**.

For general information about using the menus and configuring settings, see **4.1 Using the Menus**.

**Note:** Some of the configuration information for the Remote Station is the same as for the Main Station. In these case, you are referred to the relevant sections of chapter 5.

### 5.1 Configuring the audio settings

#### 5.1.1 Audio settings for the headset

To configure the audio settings for the headset, see **4.2.1 Audio settings for the headset**.

**Note:** This does not apply to the Remote Station in expansion mode.

#### 5.1.2 Audio settings for the microphone

To configure the audio settings for the microphone, see **4.2.2 Audio settings for the microphone**.

**Note:** This does not apply to the Remote Station in expansion panel mode.

#### 5.1.3 Settings for program/audio in

To configure the audio settings for the program/audio in:

- 1) In **Menu mode**, select **Audio Settings** and then **PGM/Audio In**.
- 2) To select the gain:
  - a) From the third menu, select **Gain**.
  - b) From the fourth menu, select one of the following:
    - + 12dB
    - + 6dB
    - 0dB (default)
    - - 6dB
    - - 12dB
  - c) To confirm the selected setting, press the **rotary control**.

- 3) To select the IFB dim level:
  - a) From the third menu, select **IFB Dim Level**.

**Note:** The IFB Dim Level determines the volume level the Program Level is reduced to when it is interrupted by the IFB.

  - b) From the fourth menu, select one of the following:
    - IFB Disabled (default)
    - - 6dB
    - -12dB
    - -18dB
    - -24dB
    - Full Cut
  - c) To confirm the selected setting, press the **rotary control**.
- 4) The GPO trigger activates a relay when receiving a call or activating a talk on a partyline channel. You can enable or disable the GPO trigger.
  - a) In Menu mode, select Audio Settings and then Program Input.
  - b) From the third menu, select **GPO Trigger**.
  - c) From the fourth menu, select one of the following:
    - Enabled (default)
    - Disabled
  - d) To confirm the selected setting, press the **rotary control**.

**Note:** You can also configure the GPO trigger using **Menu Mode > Modules Settings**.
- 5) To select the VOX:
  - e) From the third menu, select **VOX**.
  - f) From the fourth menu, select one of the following:
    - Enabled
    - Disabled (default)
  - g) To confirm the selected setting, press the **rotary control**.
- 6) To select the VOX Off Delay:
  - a) From the third menu, select **VOX Off Delay**.



- b) From the fourth menus, select one of the following:
  - .5 sec (default)
  - 1 sec
  - 2 sec
  - 3 sec
  - 4 sec
- c) To confirm the selected setting, press the **rotary control**.

#### 5.1.4 Audio settings for the SA (Stage Announce) output

To configure the settings for the SA output:

- 1) In **Menu mode**, select **Audio Settings** and then **SA/Audio out**.
- 2) To select the mode:
  - a) From the third menu, select **Mode**.
  - b) From the fourth menu, select one of the following:
    - Channel Assigned (default)
    - SA
  - c) To confirm the selected setting, press the **rotary control**.
- 3) To select the gain:
  - a) From the third menu, select **Gain**.
  - b) From the fourth menu, select one of the following:
    - +12dB
    - +6dB
    - 0dB (default)
    - -6dB
    - -12dB
  - c) To confirm the selected setting, press the **rotary control**.
- 4) The Program Output setting enables the program to be delivered to this output if it is assigned to a channel that also has a program feed assigned. To select the program output:
  - a) From the third menu, select **Program Output**.

- b) From the fourth menu, select one of the following:
    - Unmute (default)
    - Mute
    - [SA Mode]
  - c) To confirm the selected setting, press the **rotary control**.
- 5) To associate one of the four available channels (or to disable channels associations) with the selected port:
- a) From the third menu, select **Channel Assign**.
  - b) From the fourth menu, select one of the following:
    - Disabled (default)
    - Channel A
    - Channel B
    - Channel C
    - Channel D
- Note:** When linking is enabled on the Main Station, there will be more than four channels.
- c) To confirm the selected setting, press the **rotary control**.

### 5.1.5 Audio settings for Hot Mic Output

To configure the audio settings for the Hot Mic Output, see **4.2.6 Audio settings for the Hot Mic Output**.

**Note:** This does not apply to the Remote Station in expansion mode.

### 5.1.6 Audio settings for the Front Panel

To configure the audio settings for the Front Panel, see **4.2.7 Audio settings for the Front Panel**.

**Note:** This does not apply to the Remote Station in expansion panel mode.

## 5.2 Selecting Station Settings

### 5.2.1 Setting Preferences

To set the **Preferences**:

- 1) In **Menu mode**, select **Station Settings** and then **Preferences**.
- 2) To give the station a name:
  - a) From the third menu, select **Station ID**, and enter a station ID with a maximum of 10 alphanumeric characters:
  - b) To confirm the selected setting, press the **rotary control**.

- 3) To select the Mode:
  - a) From the third menu, select **Mode**.
  - b) From the fourth menu, select one of the following:
    - Intercom
    - Expansion panel. This allows a Remote Station to be co-located with another Remote Station and used as an additional four keysets. In that mode, the expansion panel's other connectors and controls will not operate.

## 5.2.2 Setting Keypad Assignments

To configure the Keypad Assignments settings, see [4.3.2 Setting Keypad Assignments](#).

## 5.2.3 Setting key latching

To configure the key latching settings, see [4.3.3 Setting key latching](#).

## 5.2.4 Settings the RMK (Remote Mic Kill) key

To configure the RMK settings, see [4.3.4 Setting the RMK \(Remote Mic Kill\) key](#).

**Note:** This does not apply to the Remote Station in expansion panel mode.

## 5.2.5 Setting display screen brightness

To configure the display screen brightness, see [4.3.5 Setting display screen brightness](#)

## 5.2.6 Setting key brightness

To configure the key brightness settings, see [4.3.6 Setting key brightness](#).

## 5.2.7 Setting the screensaver

To configure the screensaver settings, see [4.3.7 Setting the screensaver](#).

## 5.3 Configuring the channel settings

### 5.3.1 Editing the channel label

To edit the channel label, see [4.4.1 Editing the channel label](#).

### 5.3.2 Assigning the Program Listen to a channel

To assign the program listen to a channel, see [4.4.2 Assigning the Program Listen to a channel](#).

### 5.3.3 Assigning a GPO relay to a channel

You can assign a relay that is triggered on receiving a call or detecting a talk on a partyline channel. See [4.4.3 Assigning a GPO relay to a channel](#).

## 5.4 Configuring the Control I/O

The Control I/O connector on the rear panel allows you to connect one relay output or one opto input and control them through the Remote Station keysets:

I/O type	Description
Opto inputs	Opto inputs enable you to connect a foot switch or other control device and use it to trigger Call or Talk functions.
Relay outputs	Relay outputs enable you to use Call or Talk keys to trigger any external device that accepts a standard contact closure (such as a theater curtain or an On Air light).

Table 5-1: Opto inputs and Relay outputs

### 5.4.1 Configuring Opto inputs

To configure the Control I/O for the Opto input:

- 1) In **Menu mode**, select **Control I/O**.
- 2) From the second menu, select **Inputs**.
- 3) From the third menu, select **Opto 1**
- 4) From the fourth menu, select one of the following:
  - None (default)
  - Call Key 1
  - Talk Key 1
  - Call Key 2
  - Talk Key 2
  - Call Key 3
  - Talk Key 3
  - Call Key 4
  - Talk Key 4

**Note:** The number of the key relates to the keyset to which it belongs (for example, Call Key 1 is the Call key for the first keyset / display screen).

- 5) To confirm the selected setting, press the **rotary control**.

## 5.4.2 Configuring the Relay output

To configure the Control I/O for the Relay output:

- 1) In **Menu mode**, select **Control I/O**.
- 2) From the second menu, select **Outputs**.
- 3) From the third menu, select **Relay 1**
- 4) From the fourth menu, select one of the following:
  - None (default)
  - Call Key 1
  - Talk Key 1
  - Call Key 2
  - Talk Key 2
  - Call Key 3
  - Talk Key 3
  - Call Key 4
  - Talk Key 4
  - SA Key

**Note:** The number of the key relates to the keyset to which it belongs (for example, Call Key 1 is the Call key for the first keyset / display screen).

- 5) To confirm the selected setting, press the **rotary control**.

## 5.5 Connecting the Remote Station to a Main Station using Ethernet

To connect the Remote Station to a Main Station:

- 1) Ensure that the Remote Station is physically connected to the Main Station.
- 2) In **Menu mode**, select **Networking**, and then **Connect to Station**.
- 3) From the third menu, select the **Station ID** to connect to.

To set the preferences:

- 1) In **Menu mode**, select **Networking**, and then **Preferences**.

- 2) From the third menu, select **DHCP**.
  - a) Select one of the following:
    - Enabled (default)
    - Disabled
- 3) From the third menu, select **IP Address**, and enter the correct IP address.
- 4) From the third menu, select **Gateway**, and enter the correct gateway address.
- 5) From the third menu, select **Subnet Mask**, and enter the correct subnet mask

## 5.6 Administration

In **Menu mode > Administration**, you can:

- View the current versions of the software for the system.
- Update the software (firmware).
- Reset the Remote Station to the default (factory mode) settings.
- Manually reboot the Remote Station.
- Save and Restore the software settings.

### 5.6.1 Viewing the current versions of the software

To view the current versions of the software on the Remote Station:

- 1) In **Menu mode**, select **Administration** and then **Software**.
- 2) From the third menu, select **Current**.
- 3) In the fourth menu, use the **rotary control** to scroll the displayed software versions. The software versions for the HelixNet system and Remote Station are shown.

### 5.6.2 Updating the software

Software can be updated from a Main Station or locally in the USB connector on the front of a Remote Station. Updating from the Main Station is recommended when possible.

To update the software:

- 1) After downloading the software update, copy the update to a USB memory stick.
- 2) Insert the memory stick into the USB connector.
- 3) In **Menu mode**, select **Administration** and then **Software**.
- 4) From the third menu, select **Update**.

- 5) The fourth menu displays the new software version information on the USB memory stick. To start updating the Main Station with the new software, press the rotary control.

The process of updating the software takes several minutes. The following system messages are displayed during the process:

Loading image  
Erasing flash  
Writing to flash  
Verifying flash  
Successful



*Do **not** turn off the power to the Remote Station during the software (firmware) update. Turning off the power can damage the device.*

**Note:** Do not remove the USB memory stick from the Main Station or Remote Station until the software update is completed.

**Note:** The Remote Station resets **automatically**. You are **not** required to restart the Remote Station. To check that the software upgrade was performed successfully, see **5.6.1 Viewing the current versions of the software**.

### 5.6.3 Resetting the Remote Station to default settings.

To reset the Remote Station to its default (factory mode) settings:

- 1) In **Menu mode**, select **Administration** and then **Reset**.
- 2) The third menu displays a selected menu item: **Reset to Default**.
- 3) In the fourth menu, select **Reset Now**.

### 5.6.4 Manually rebooting the Remote Station

To manually reboot the Remote Station:

- 1) In **Menu mode**, select **Administration** and then **Reset**.
- 2) The third menu select **Reboot**.
- 3) In the fourth menu, select **Reboot Now**.

When the **rotary control** is pressed, the display changes to **Rebooting ...** for 2 seconds, and then the Remote Station reboots.

## 5.6.5 Saving and restoring the software settings.

To save or restore the software settings:

- 1) In **Menu mode**, select **Administration** and then **Settings**.
- 2) To save, in the third menu, select **Save**. Once you select **Save** you should not remove the USB stick right away. Depending on the USB stick it might take up to 5 seconds to complete.
  - a) In the fourth menu, select between saving to a USB stick or saving locally.
- 3) To restore, in the third menu, select **Restore**.
  - a) In the fourth menu, select between restoring from a USB stick or restoring from a list of files.

## 5.7 Diagnostics

The **Diagnostics** menus help you to monitor the performance of the Remote Station and diagnose possible system issues.

### 5.7.1 Viewing powerline information and status

To view line information and status:

- 1) In **Menu mode**, select **Diagnostics** and then **Powerlines**.
- 2) From the third menu, select Powerline 1.
- 3) The fourth menu displays the status and other measures / information for the powerline. The status of the powerline is either **Ok** [operating normally], **Busy** or **Error**.

For more details of the information displayed, see **16 Menu maps**.

**Note:** Powerline status is also indicated by the powerline LEDs on the front panel.

**Green** LED = **Ok**

**Amber** LED = **Busy**

**Red** LED = **Error**

For more information about powerline diagnostics, see **18 Troubleshooting**.

### 5.7.2 Viewing network information

To view network status information:

- 1) In **Menu mode**, select **Diagnostics** and then **Network**.
- 2) To view status information about the powerline:
  - a) From the third menu, select **Powerline**.
  - b) On the fourth menu, the IP address is given.



- 3) To view status information about the Ethernet:
  - a) From the third menu, select **Ethernet**.
  - b) On the fourth menu, the IP address is given.

### 5.7.3 Viewing keyset information

To view information about the keysets:

- 1) In **Menu mode**, select **Diagnostics** and then **Keysets**.
- 2) From the third menu, select a keyset from 1 to 4.
- 3) The fourth menu displays the following status information:
  - **Name** – The channel name
  - **Talkers** – The number of talkers on the partyline
  - **Main Stations** – The number of Main Stations listening
  - **Beltpacks** – The number of beltpacks listening on the partyline
  - **Remote** – The number of Remote Stations listening
  - **Speaker** – The number of Speaker Stations listening.
  - **2-Wire** – The number of 2-wire ports listening
  - **4-Wire** – The number of 4-wire ports listening

## 6 Configuring and managing the Speaker Station

---

This chapter describes how to configure the settings and manage the Speaker Station using **Menu mode**. It also shows you how to monitor and diagnose performance issues, using the **Diagnostics** menus.

**Tip:** For a quick reference to the Speaker Station menus, see **16 Menu maps**.

For general information about using the menus and configuring settings, see **4.1 Using the Menus**.

There is a next and a back activated by pressing the rotary encoders (right one for next, left one for back). There are two levels of the menu, one on the left screen and one on the right. Next and back shifts the menu by one level down or up.

### 6.1 Using the Menus

To place the Speaker Station in **Menu mode**, press the **Menu key**. The Speaker Station menus appear in the display screens.

#### 6.1.1 Configuring settings

To configure settings:

- 1) For each menu, turn the **rotary control** to scroll the menu items. Turn the rotary control:
  - Counter-clockwise to scroll up the menu items.
  - Clockwise to scroll down the menu items.

To return to the previous level of menu, press the **left-hand rotary key**.

To go to the next level of menu, press the **right-hand rotary key**.

**Selected menu items** are highlighted in solid yellow.

- 2) When you have selected a setting, press the **right-hand rotary key** to enable the setting on the Speaker Station.

#### 6.1.2 Exiting Menu mode

To exit **Menu mode** do either of the following:

- Press the **Menu key**.
- Wait until Menu mode times out. If you fail to press any key on the Speaker Station for 20 seconds, the display screen reverts to showing the standard channel information.

### 6.2 Configuring the Audio settings

#### 6.2.1 Audio settings for the headset

To configure the audio settings for the headset, see **4.2.1 Audio settings for the headset**.

## 6.2.2 Audio settings for the microphone

To configure the audio settings for the microphone, see **4.2.2 Audio settings for the microphone**.

## 6.2.3 Audio settings for the Front Panel

To configure the audio settings for the front panel, see **4.2.7 Audio settings for the Front Panel**.

## 6.3 Station Settings

### 6.3.1 Setting Preferences

To set the Preferences, see **5.2.1 Setting Preferences**

### 6.3.2 Setting Keypad Assignments

To configure the Keypad Assignments settings, see **4.3.2 Setting Keypad Assignments**.

### 6.3.3 Setting key latching

To configure key latching, see **4.3.3 Setting key latching**.

You can also configure key latching so that the Talk keys automatically unlatch whenever the Shift key is pressed. To do so:

- 1) In Menu mode, select **Station Settings** and then **Keypads**.
- 2) From the third menu, select **Unlatch on Shift**.
- 3) From the fourth menu select:
  - Enabled (default)
  - Disabled

### 6.3.4 Setting display screen brightness

To configure display screen brightness, see **4.3.5 Setting display screen brightness**.

### 6.3.5 Setting key brightness

To configure key brightness, see **4.3.6 Setting key brightness**.

### 6.3.6 Setting the screensaver

To configure the screensaver, see **4.3.7 Setting the screensaver**.

## 6.4 Connecting the Speaker Station to a Main Station

To connect the Speaker Station to a Main Station, see **5.5 Connecting the Remote Station to a Main Station using Ethernet**.

## 6.5 Administration

### 6.5.1 Viewing the current versions of the software

To view the current version of the software, see **5.6.1 Viewing the current versions of the software**.

### 6.5.2 Updating the software

To update the software, see **5.6.2 Updating the software**.

**Note:** You can only update the Speaker Station software from the Main Station.

### 6.5.3 Resetting the Speaker Station to default (factory mode) settings.

To reset the Speaker Station to its default (factory mode) settings see :

- 1) In **Menu mode**, select **Administration** and then **Reset**.
- 2) The third menu displays a selected menu item: **Reset to Default**.
- 3) In the fourth menu, select **Reset Now**.

### 6.5.4 Manually rebooting the Speaker Station

To manually reboot the Speaker Station:

- 1) In **Menu mode**, select **Administration** and then **Reset**.
- 2) The third menu select **Reboot**.
- 3) In the fourth menu, select **Reboot Now**.

When the **rotary control** is pressed, the display changes to **Rebooting ...** for 2 seconds, and then the Speaker Station reboots.

## 6.6 Diagnostics

### 6.6.1 Viewing powerline information and status

To view powerline information and status, see **5.7.1 Viewing powerline information and status**.

### 6.6.2 Viewing network information

To view network information, see **5.7.2 Viewing network information**.

### 6.6.3 Viewing keysets information

To view key sets information, see **5.7.3 Viewing keyset information**.

## 7 Configuring and managing the HBP-2X Beltpack

---

This chapter describes how to configure the settings and manage the HBP-2X Beltpack using **Menu mode**. It also shows you how to monitor and diagnose performance issues, using the **Diagnostics** menus.

**Tip:** For a quick reference to the Main Station menus, see **16 Menu maps**.

### 7.1 Using the Menus

To place the beltpack in **Menu mode**, press the **Menu key** on the top of the beltpack.

**Note:** The **Beltpack** menu comes up in the **Beltpack Settings** menu by default.

**Note:** If Menu mode is **locked** on the beltpack, you must unlock the menus (for all beltpacks) on the HMS-4X Main Station before you can enter the menu. See **4.7 Administration**.

#### 7.1.1 Configuring settings

To configure settings:

- 1) For each menu, turn either of the side-mounted **rotary controls** to scroll the menu items. Turn the rotary control:
  - Counter-clockwise to scroll up the menu items.
  - Clockwise to scroll down the menu items.

Off-screen menu items are indicated with arrows at the top and / or bottom of the display screen.

**Back** (with an arrow pointing **left**) indicates a previous level of menu.

To return to the previous level of menu, press the **left-hand Call key**.

An arrow pointing **right** indicates another level of menu under that menu item.

To go to the next level of menu, press the **right-hand Call key**.

**Selected menu items** are highlighted in solid yellow.

- 2) The final level of menu (the second or third display screen) displays the settings that relate to your previous menu choices (system features or functionality).

The **current setting** is indicated by a dotted box around the menu item

When you have selected a setting, press the **right-hand Call key** to enable the setting on the Main Station.

#### 7.1.2 Exiting Menu mode

To exit **Menu mode** on the beltpack, do either of the following:

- Press the Menu key.
- Wait until Menu mode times out. If you fail to press any key on the beltpack for 20 seconds, the display screen reverts to showing the standard channel information.

## 7.2 Configuring the Audio settings

To configure the audio settings for the headset:

- 1) In **Menu mode** press the left-hand Call Key and then select **Audio Settings**.
- 2) To adjust sidetone gain on the headset:
  - a) Select Sidetone Gain.
  - b) Select one of the following:
    - 0dB
    - -6dB
    - -12dB (default)
    - -18dB
  - c) To confirm the selected setting, press the **right-hand Call key**.

Go back to the previous menu level by pressing the **left-hand Call key**.

- 3) To limit the maximum audio level that can be delivered to the headphones:
  - a) Select Headphone Limit.
  - b) Select one of the following:
    - Off
    - +6dB
    - 0dB (default)
    - -6dB
  - c) To confirm the selected setting, press the **right-hand Call key**.

**Note:** When Headphone Limit is set to anything except **Off**, a LIM indication will show up at the top right of the display

Go back to the previous menu level by pressing the **left-hand Call key**.

- 4) Sidetone tracking means that the sidetone level varies according to the main volume level. To set (or disable) sidetone tracking on the headset:
  - a) Select Sidetone Control.
  - b) Select one of the following:
    - Tracking (default)
    - Non-Tracking
    - Disabled
  - c) To confirm the selected setting, press the **right-hand Call key**.

Go back to the previous menu level by pressing the **left-hand Call key**.

- 5) To set the type of mic on the headset:
  - a) Select **HS Mic Type**.
  - b) Select either of the following types of mic.
    - Electret (-15 dB)
    - Dynamic (0 dB) (default)
    - Dynamic (-10 dB)

**Note:** In electret mode, phantom power is provided for an electret mic. In dynamic mode, no phantom power is provided. Mic input levels are also adjusted between the different modes to suit the different mic types.

- c) To confirm the selected setting, press the **right-hand Call key**.

## 7.3 Audio settings for the microphone

To configure the audio settings for the microphone:

- 1) In Menu mode, select **Audio Settings** and then **Microphone**.
- 2) To select the Headroom:
  - a) From the third menu, select **Headroom**.
  - b) From the fourth menu, select one of the following:
    - Normal (default)
    - High
- 3) To enable or disable the Contour Filter:
  - a) From the third menu, select **Contour Filter**
  - b) From the fourth menu, select one of the following:
    - Enabled (default)
    - Disabled

## 7.4 Configuring the Beltpack Settings

In **Menu mode > Beltpack Settings**, you can:

- Assign channels to the left and right beltpack keysets (set of controls).
- Enable (or disable) **Talk key** latching.
- Enable (or disable) beltpack vibration when a call signal is received.

**Tip:** For a quick reference to the keysets on the HBP-2X Beltpack, see **2.5.1 HBP-2X user controls (front and side view)**.

## 7.4.1 Assigning channels

You can assign any two available channels to the beltpack (including the same channel to both keysets).

To assign a channel:

- 1) In Beltpack Settings select Left Channel or Right Channel.
- 2) Select one of the available channels (or none):
- 3) To confirm the selected setting, press the **right-hand Call key**.

## 7.4.2 Setting Talk key latching

To enable (or disable) **Talk key** latching:

- 1) In Beltpack Settings select Right Talk Latch or Left Talk Latch
- 2) Select one of the following:
  - Latching (default)
  - Non-Latching

**Note:** The setting applies to both channels on the beltpack.

- 3) To confirm the selected setting, press the **right-hand Call key**.

## 7.4.3 Setting the beltpack to vibrate when called

To enable (or disable) vibration when a **Call signal** is received:

- 1) In Beltpack Settings select Vibrate on Call.
- 2) Select one of the following:
  - On
  - Off (default)
- 3) To confirm the selected setting, press the **right-hand Call key**.



## 7.5 Configuring the Display Settings

In **Menu mode > Display Settings**, you can:

- Set the brightness of the display screen.
- Set the brightness of the **Talk** and **Call** keys.
- Enable (or disable) the screensaver.
- Rotate the display.

### 7.5.1 Setting display screen brightness

By default, the display screen is set to **medium** brightness. To set the brightness of the display screen:

- 1) In **Menu mode**, press the left-hand Call Key and then select **Display Settings**.
- 2) Select OLED Brightness.
- 3) Select one of the following:
  - High
  - Medium (default)
  - Low
- 4) To confirm the selected setting, press the **right-hand Call key**.

### 7.5.2 Setting the brightness of the Talk and Call keys

By default, the **Talk** and **Call keys** are lit when **active (on)** and dim when **inactive (off)** (**High / Low**).

To set the brightness of the Talk and Call keys:

- 1) In **Menu mode**, press the left-hand Call Key and then select **Display Settings**.
- 2) Select Key Brightness.
- 3) Select one of the following brightness settings:

Key(s)	Description
High / Low (default)	Keys are brightly lit when active (on) and dim when inactive (off).
High / Off	Keys are lit when active (on) and are unlit when inactive (off).
Low / Off	Keys are lit dim when active (on) and are unlit when inactive (off).
Off / Off	Keys are unlit, whether or not they are active (on) or inactive (off).

**Table 7-1: Setting the brightness of the Talk, Call and Menu keys**

- 4) To confirm the selected setting, press the **right-hand Call key**.

### 7.5.3 Setting the screensaver

The screensaver is displayed on screen after 10 minutes of inactivity on the beltpack. To enable (or disable) the screensaver:

- 1) In **Menu mode**, press the left-hand Call Key and then select **Display Settings**.
- 2) Select **Screensaver**.
- 3) Select one of the following:
  - Enabled (default)
  - Disabled
- 4) To confirm the selected setting, press the **right-hand Call key**.

## 7.6 Administration

In **Menu mode > Administration**, you can:

- View the IP address for the network.
- View the current version of the software on the beltpack.
- Reset the beltpack to default (factory mode) settings.

*The beltpacks receive updated (default) channel label information. Other local beltpack settings will **not** be reset if the Main Station is reset to default settings.*

### 7.6.1 Viewing the IP address

To view the IP address for the network:

- 1) In **Menu mode**, press the left-hand Call Key and then select **Administration**.
- 2) Select **IP Address**.
- 3) The IP address for the network is displayed. The IP address appears similar to the following example:

10.0.0.1

To view the current version of the software on the beltpack:

- 1) In **Menu mode**, press the left-hand Call Key and then select **Administration**.
- 2) Select Software Version.
- 3) The current version of the software is displayed. The software version information will appear similar to the following example:

npl-**x.x.xx.xxxx**, uboot

Where **x** is a numerical value.

## 7.6.2 Resetting the beltpack to default (factory mode) settings

To reset the beltpack to default (factory mode) settings:

- 1) In **Menu mode**, press the left-hand Call Key and then select **Administration**.
- 2) Select Reset to Default.
- 3) **Reset Now** is displayed (shown as selected). To reset the beltpack, press the **right-hand Call key**.

## 7.7 Diagnostics

The **Diagnostics** menus help you to monitor the performance of the beltpack and diagnose possible system issues.

### 7.7.1 Viewing information about the hardware (main PCB) on the beltpack

To view information about the **Part**, **Revision** and **Serial number** of the main PCB on the beltpack:

- 1) In **Menu mode**, press the left-hand Call Key and then select **Diagnostics**.
- 2) Select Hardware > Main PCB.

The **Part**, **Revision** and **Serial number** for the PCB are displayed. The format is similar to the following:

```
Part xxxxxxxx  
Revision: x  
Serial: x
```

Where **x** is a numerical value.

### 7.7.2 Viewing powerline information and status

To view powerline information and status:

- 1) In **Menu mode**, press the left-hand Call Key and then select **Diagnostics**.
- 2) Select **Powerline**.

The status and other powerline information are displayed. For more information, see **16 Menu maps**.

## 8 Linking Main Stations

---

This chapter describes how to link Main Stations. You can connect Main Stations directly using Ethernet or Fiber, or connect them over a LAN via Ethernet.

Main Station linking is achieved using interface modules fitted to the extension bay of the Main Station. There are two modules:

- Ethernet interface module (HLI-ET2). This module provides an Ethernet connection between Main Stations.
- Fiber interface module (HLI-FBS). This module provides a Fiber connection between Main Stations.

Each Main Station has four channels, and can connect up to 20 beltpacks.

**Note:** If you change the network topology between any two stations, you must reboot the stations.



**Warning:** Both ports are configured to bridge traffic from one port to the other in order to work in daisy-chain. Spanning Tree Protocol is not enabled on those ports, therefore do not connect them both to the same network.

### 8.1 Linking scenarios

Main Stations are connected together using CAT, CAT5e or CAT6 shielded cable. They can also be connected using fiber. There are various topologies that you can create. Some of these are illustrated below.

## 8.1.1 Linking two Main Stations with Ethernet

- 1) Insert an HLI-ET2 Ethernet interface module in each station. Use any of the three slots available.  
**Note:** Ensure that the Main Station is powered down before inserting modules.
- 2) Connect a regular Ethernet cable (for example, CAT5, CAT5e, CAT6, CAT6e) from one HLI-ET2 port on one station to one HLI-ET2 port on the other station.
- 3) Power up both stations. Verify that the green LED on each HLI-ET2 port is flashing.
- 4) Go to **Networking->Stations** menu on each station. You should see two entries on each screen indicating that each station properly sees itself and the other station.
- 5) Go to **Networking->Linking->Link Station** menu on each station and select **Enabled**. You now have an 8 channel system and can start assigning channels to Main Stations and Beltpacks.

**Note:** You should see a Link icon  on the Main Station display.

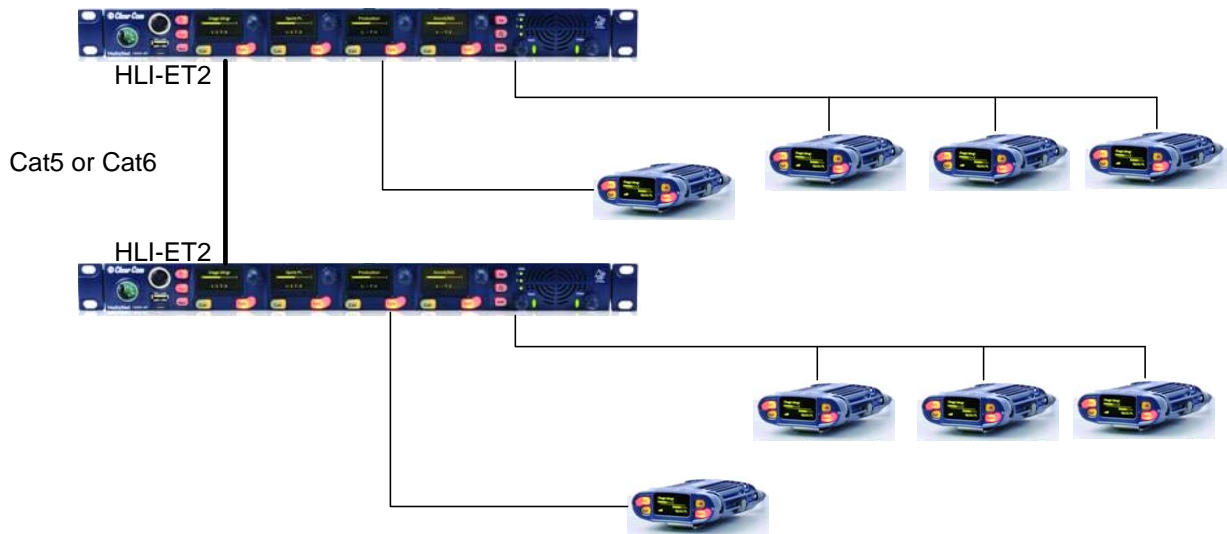

Figure 8-1: Linking two stations with Ethernet

## 8.1.2 Linking two Main Stations with Fiber

- 1) Insert an HLI-FBS Fiber interface module in each station. Use any of the three slots available.  
**Note:** Ensure that the Main Station is powered down before inserting modules.
- 2) Ensure that an SFP Transceiver is connected into one HLI-FBS module port on each station.
- 3) Connect Two Fibers from one HLI-FBS port on one station to one HLI-FBS port on the other station. If using Single connector fiber, make sure that Tx on one goes to Rx on the other.
- 4) Power up both stations. Verify that the green LED on each HLI- FBS port is flashing.
- 5) Go to **Networking->Stations** menu on each station. You should see two entries on each screen indicating that each station properly sees itself and the other station.
- 6) Go to **Networking->Linking->Link Station** menu on each station and select **Enabled**. You now have an 8 channels system and can start assigning channels to Main Stations and Beltpacks.

**Note:** You should see a Link icon  on the Main Station display.

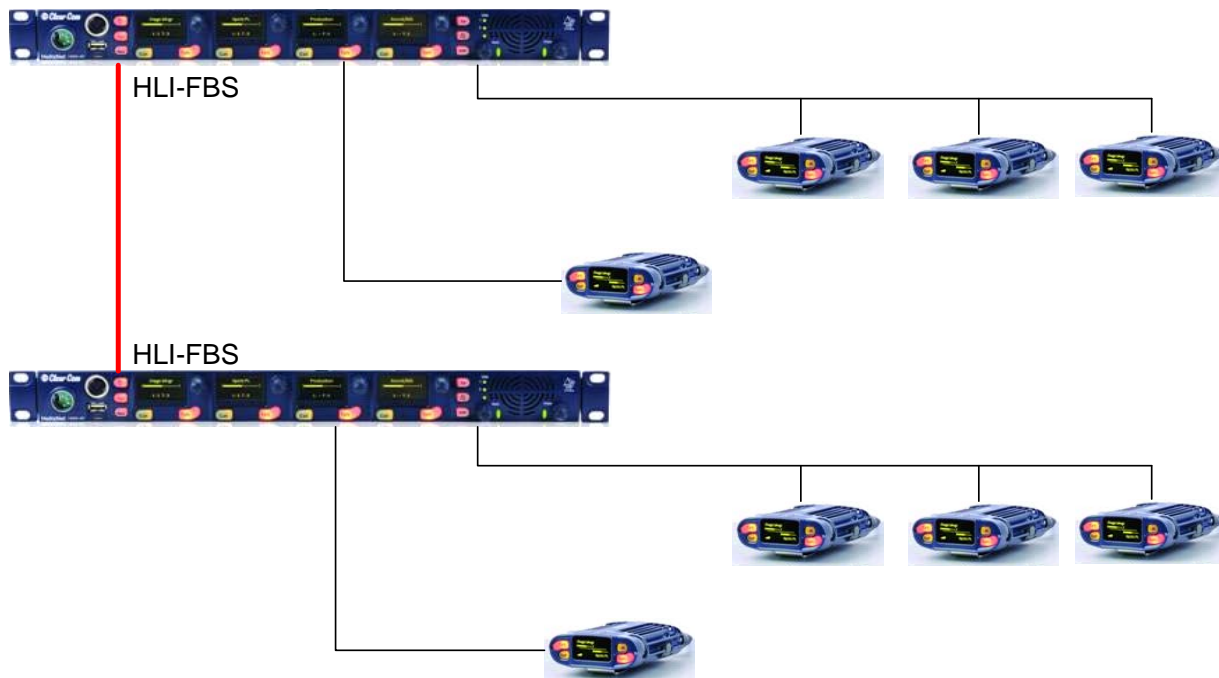

Figure 8-2: Linking two stations with Fiber

### 8.1.3 Linking three Main Stations in a daisy chain

You can daisy chain stations following all the instructions of the previous sections using the second port on one of the HLI-ET2 or HLI-FBS module to connect to a third station. Then enable linking on the third station. The advantage of daisy chain is that it does not require any additional equipment for interconnection. The disadvantage is that if you disconnect or power down a station in the middle it will break the chain and prevent audio from passing between the units either side of the break.

You can also mix Ethernet and Fiber in the chain using an additional slot in a station in the middle of the chain.

Alternatively, you can save a slot by using an HLI-FBS module in the middle station, populating one port with a fiber SFP transceiver and one port with a 10/100Base-T electrical SFP transceiver.

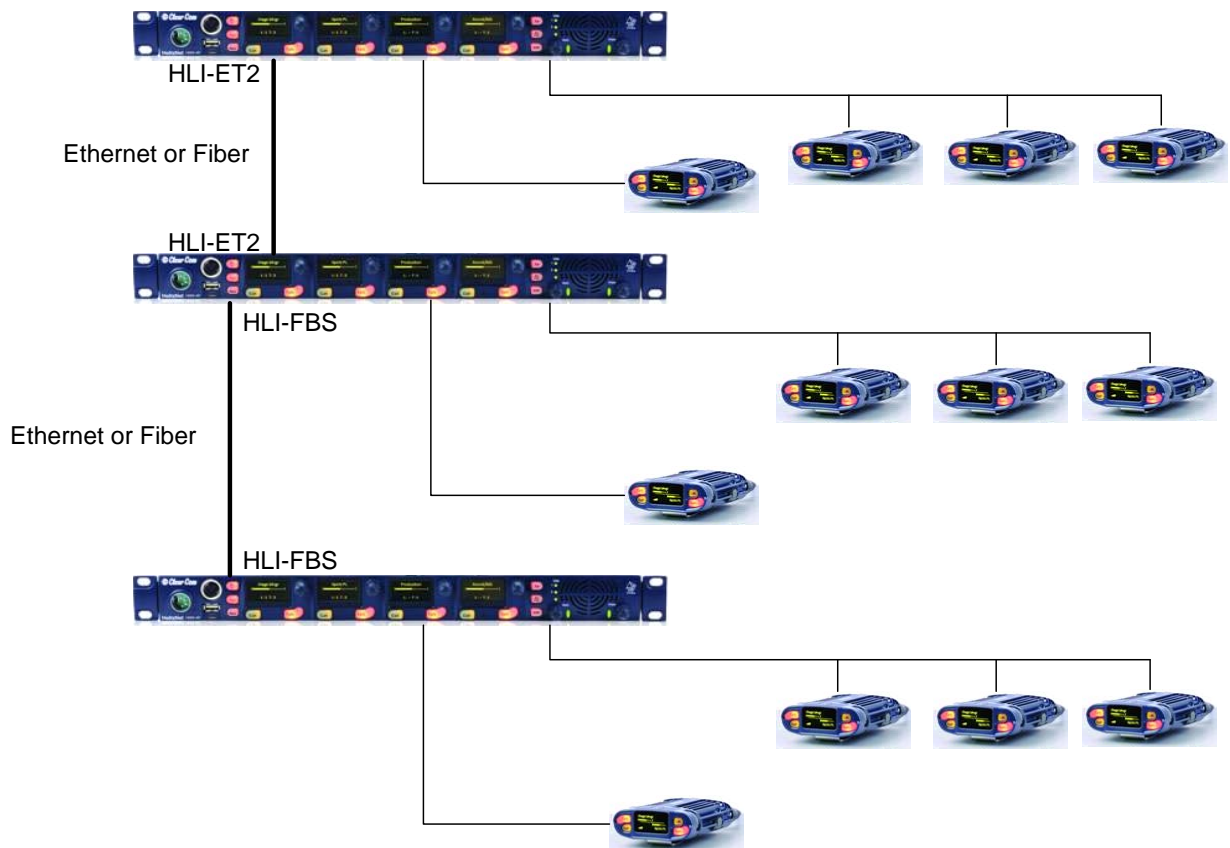

Figure 8-3: Linking three Main Stations in a daisy chain

## 8.1.4 Network connections

Connecting in an existing IP network requires planning with your IT department in order to plan the IP addressing scheme. By default HelixNet Main Station uses automatic IP addressing (DHCP) enabled. In order for that to work properly in an existing IP network there must be a DHCP server handing out IP addresses. If no DHCP server is found, a Main Station will revert to an unused link-local address in the 169.254.0.0/16 block.

Through the Networking menu you can disable DHCP and set static IP addresses. When you assign static IP addresses you need to make sure that the Main Stations you want to link together are part of the same subnet. The following figure shows an example of Static IP addresses and Subnet Mask that would work. For more information on IP addresses and subnets see <http://en.wikipedia.org/wiki/Subnetwork>.

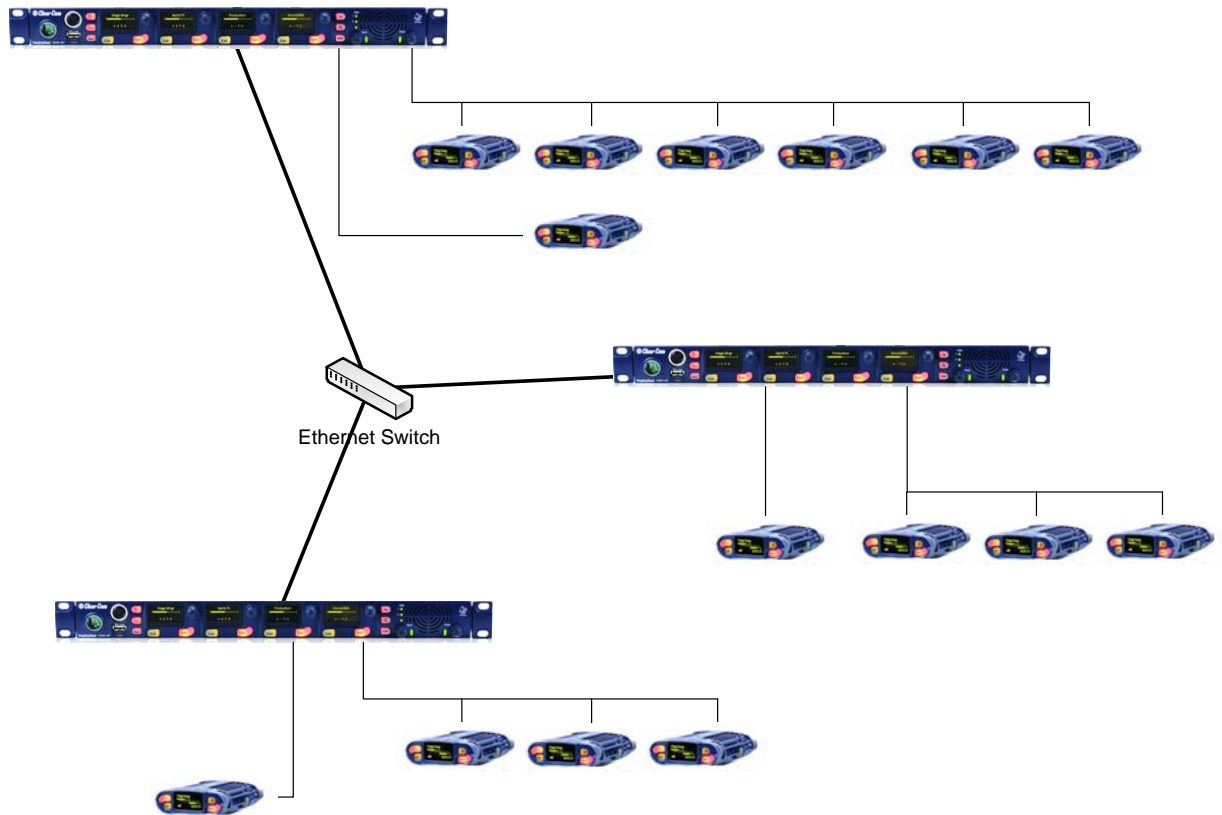
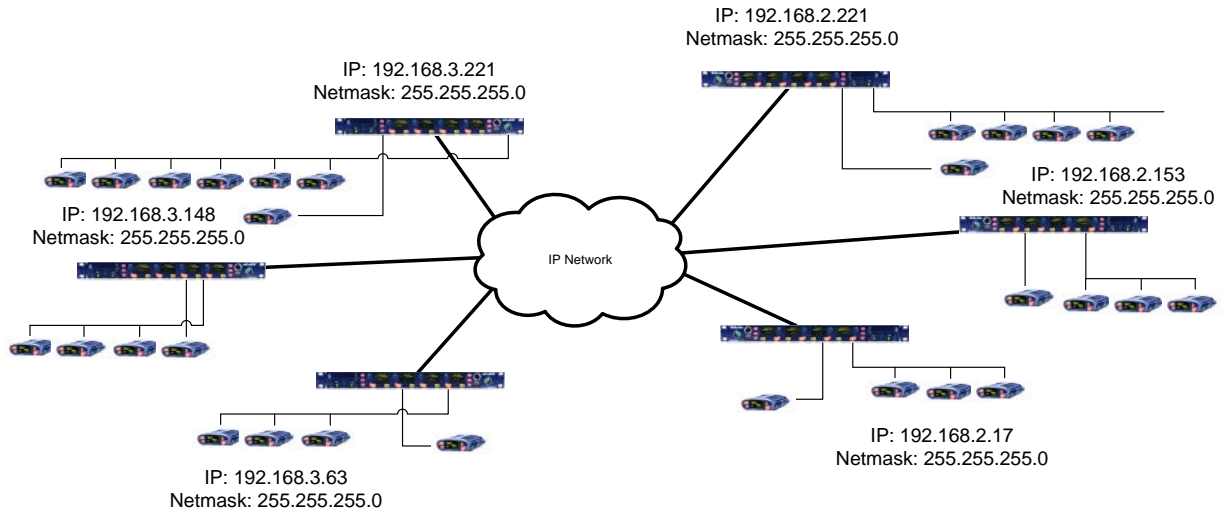

Figure 8-4: Network connections



## 8.1.5 Multiple Groups in the same IP Network

You can have multiple groups of Main Stations linked together. Each group must be part of a different subnet. Here is an example of IP addresses and subnets that would allow two independent groups of Main Stations in the same IP network.



**Figure 8-5: Multiple Groups in the same IP Network**

Here the Subnet Mask is set to 255.255.255.0 indicating that a Subnet is identified by the first three numbers of the IP address. The three Main Stations on the left share the same 192.168.3.0 subnet prefix the three on the right share the same 192.168.2.0 subnet prefix. When powered up the three on the left would see each other (in the Networking->Stations menu), the three on the right see each other but one group cannot see the other. When linking is enabled on all, you would end up with two 12-channels systems, one in the 192.168.2.0 subnet and one in the 192.168.3.0 subnet all working on the same IP infrastructure.

## 8.1.6 Resource Sharing between Linked Stations

The number of partyline channels available in your system will increase by 4 for each Main Station linked together. At the moment of linking, channels with exactly the same name will merge their audio together then only one will remain. When that happens, an additional channel name will be automatically generated (Ch 98798E-b in the following example).

Once linked, each Main Station still “owns” 4 channels. When a station is disconnected or powered down, a broken link icon  will appear on the remaining Main Station displays. The names of the channels owned by that station will go *Italic*.

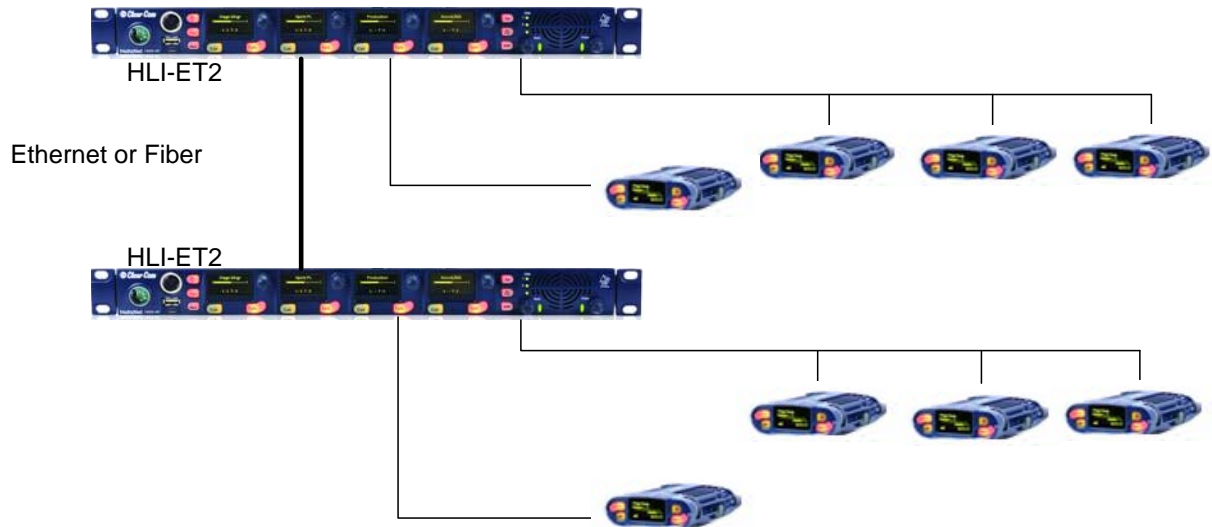

Figure 8-6: Resource sharing between linked stations

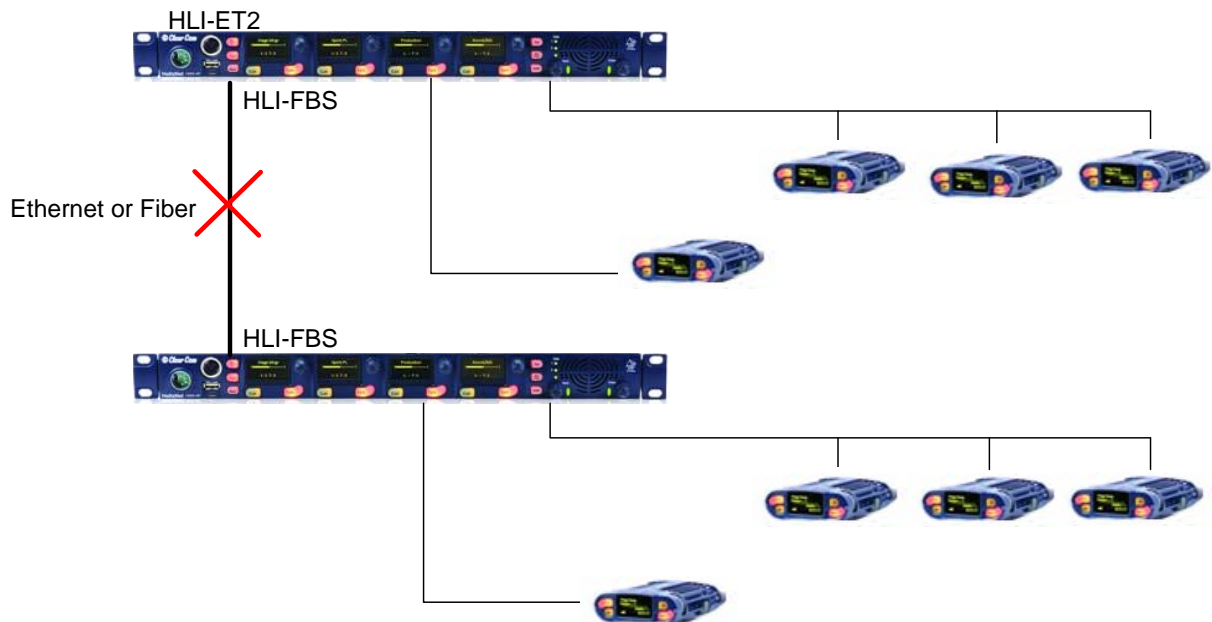

Figure 8-7: Resource sharing between unlinked stations

The following tables show how the labels appear before and after linking.

Channel number	Station 1 Labels	Station 2 Labels
1	Sound	Lighting
2	Stage	Stage
3	LD Private	Director
4	Spots	SPOTS

**Table 8-1 Labels before enabling linking**

Channel number	Station 1 Labels	Station 2 Labels	Linked Network Label	
1	Sound		Sound	"Owned" by Station 1
2	Stage	Stage	Stage	
3	LD Private		LD Private	
4	Spots		Spots	
5		Lighting	Lighting	"Owned" by Station 2
6			Ch 98798E-b	
7		Director	Director	
8		SPOTS	SPOTS	

**Table 8-2 Labels after enabling linking**

Labels after link is severed

Channel number	Station 1 Labels	Station 2 Labels	Linked Network Label
1	Sound	Sound	"Owned" by Station 1
2	Stage	Stage	
3	LD Private	LD Private	
4	Spots	Spots	
5	<i>Lighting</i>	<i>Lighting</i>	"Owned" by Station 2
6	<i>Channel 6</i>	<i>Channel 6</i>	
7	<i>Director</i>	<i>Director</i>	
8	<i>SPOTS</i>	<i>SPOTS</i>	

**Table 8-3 Labels after link is severed**

## 8.2 Networking Specifications

Specification	Value
Latency on Powerline	40-80ms (Depends on cable type and length, and how many devices are connected. The greater the number of devices, the greater the latency.)
Latency over IP Network	30ms + Network Latency (Main Station to Main Station)
Bandwidth used	300 kbps per active Talker, for a maximum of 1 talker per device in the system Each Beltpack and Speaker Station counts as 1 device Each Main Station and Remote Station counts as 2 devices
IP version	IPv4

**Table 8-4 Networking specifications**

## 9 Linking Remote Stations and Speaker Stations

---

This chapter describes how to pair Remote and Speaker Stations to Main Stations. You can connect Remote and Speaker Stations on one of the Digital Intercom Lines, point-to-point to a Main Station Ethernet interface module (HLI-ET2) or over an IP network.

Pairing to a Main Station over an IP network requires an Ethernet interface module fitted to the extension bay of the Main Station (HLI-ET2).

**Note:** If you change the network topology between any two stations, you must reboot the stations.

**Note:** If the IP address on a Remote Station or Speaker Station changes, you must either reboot the Remote Station or disable and then re-enable the DHCP on the Remote Station.



**Warning:** Digital intercom lines and the Ethernet connections are mutually exclusive on Remote and Speaker Stations. If both are connected it will be detected as a fault, communication over both ports will stop and both status LEDs will blink RED. This requires a reboot of the station using **Administration > Reset > Reboot**



**Warning:** When changing the connection from digital intercom line to Ethernet or vice-versa, you must disconnect one cable and then wait until the unit has detected a loss of connection before connecting the other cable. Otherwise, they will briefly be detected as both connected.



**Warning:** When changing the power connections to a Remote Station, a network storm error message may appear. If so, disconnect the power cable, and reboot the Remote Station.

## 9.1 Pairing scenarios

There are various topologies that you can create. Some of these are illustrated below.

### 9.1.1 Digital Intercom

Remote and Speaker Stations have Digital Intercom 3-pin XLR connectors (female and male) and can connect to Main Stations along with Beltpacks.

**Note:** A Remote or a Speaker Station draws current equivalent to three Beltpacks when the loudspeaker is in use. If the Remote or Speaker Station is locally powered using a power supply, it does not draw current from the digital intercom line.

- 1) Connect an XLR cable from a Main Station to the Remote or Speaker Station.
- 2) Power up the Main Station and verify that the Line 1 and Line 2 status LED are green on Main Station.
- 3) On a Remote Station you can verify that the Line status LED is steady green.

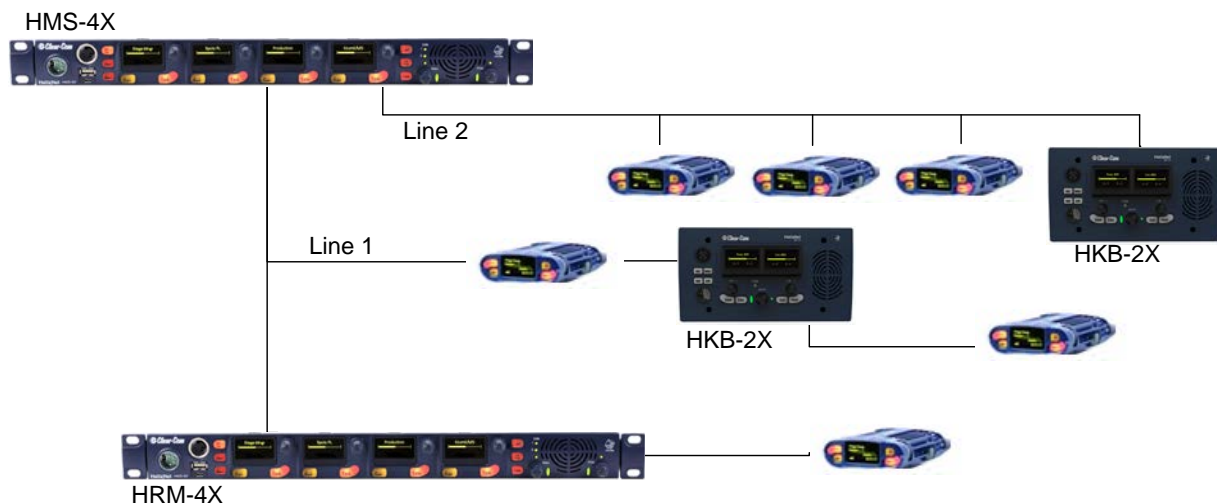

## 9.1.2 Ethernet point-to-point link

Remote and Speaker Stations have RJ45 Ethernet connectors and can connect to Main Stations over Ethernet.

- 1) Insert an HLI-ET2 Ethernet interface module in the Main Station. Use any of the three slots available.  
**Note: Ensure that the Main Station is powered down before inserting modules.**
- 2) Connect a regular Ethernet cable (for example, CAT5, CAT5e, CAT6, CAT6e) from one HLI-ET2 port on one station to the Remote or Speaker Station.
- 3) Connect an external AC/DC power adapter to the Remote or Speaker Station
- 4) Power up both Stations. Verify that the green LEDs on the HLI-ET2 port and on the Remote or Speaker Station are on.
- 5) Go to **Networking->Pair to Station->By Name** on the Remote or Speaker Station. You should see one entry indicating that the Remote or Speaker Station has properly detected the Main Station. Select this entry.
- 6) Go to **Station Settings->Keyset Assign** and assign channels to any keyset.

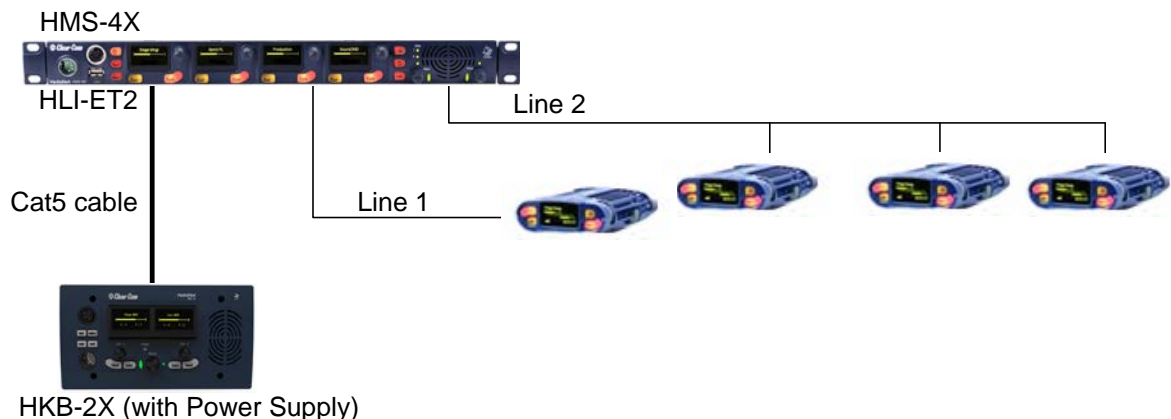
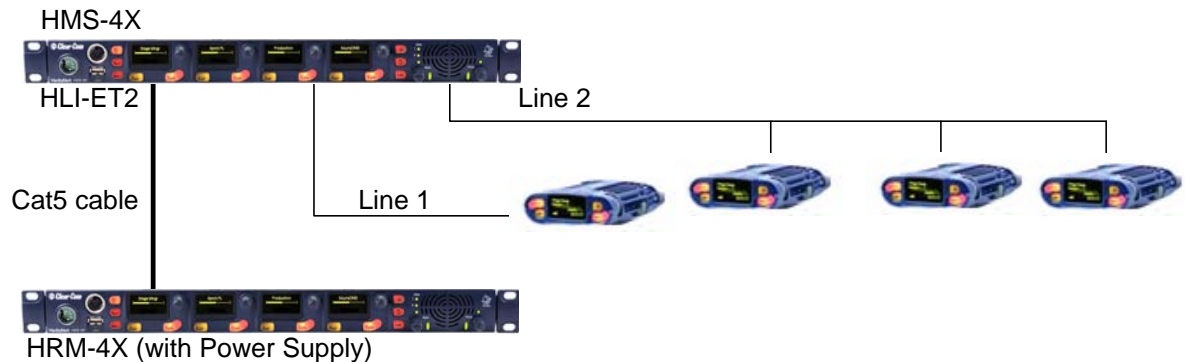

### 9.1.3 Local IP Network

- 1) Insert an HLI-ET2 Ethernet interface module into the Main Station. Use any of the three slots available.  
**Note: Ensure that the Main Station is powered down before inserting modules.**
- 2) Connect a regular Ethernet cable (for example, CAT5, CAT5e, CAT6, CAT6e) from one HLI-ET2 port to an Ethernet Switch and connect Remote or Speaker Stations to Ethernet Switch as well.
- 3) Connect an external AC/DC power adapter to the Remote or Speaker Station or connect them on a Power over Ethernet (PoE) port on the Ethernet Switch.
- 4) Power up all Stations. Verify that the green LED on the HLI-ET2 port and on the Remote or Speaker Station is on.
- 5) Go to **Networking->Link to Station->By Name** on each Remote and Speaker Station. You should see one entry indicating that the Remote or Speaker Station has properly detected the Main Station. Select this entry.
- 6) Go to **Station Settings->Keyset Assign** and assign channels to any keyset.

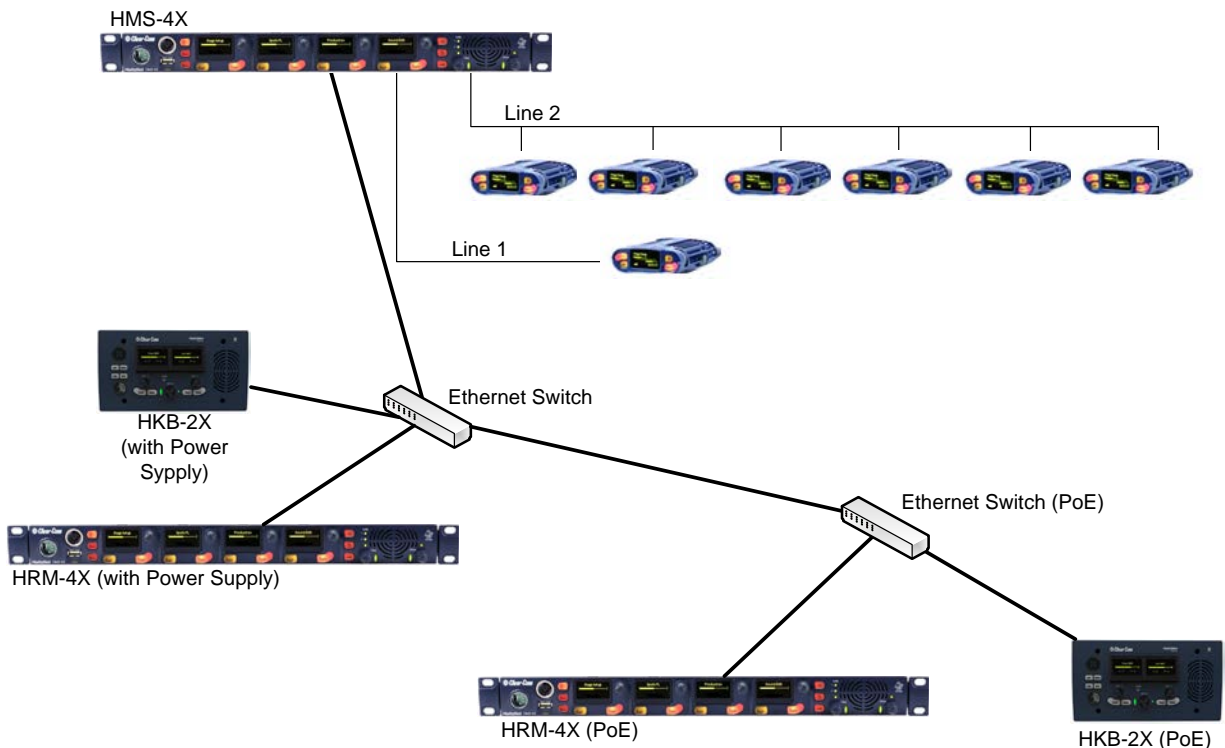



## 9.1.4 Remote IP Network

Remote and Speaker Stations can connect to a Main Station that is not within the same network Broadcast Domain.

- 1) Insert an HLI-ET2 Ethernet interface module in the Main Station. Use any of the three slots available.  
**Note: Ensure that the Main Station is powered down before inserting modules.**
- 2) Connect a regular Ethernet cable (for example, CAT5, CAT5e, CAT6, CAT6e) from one HLI-ET2 port to a Router/Gateway. Make sure you know the Gateway IP address for that first subnet.
- 3) Connect Remote or Speaker Stations to a Router/Gateway. Make sure you know the Gateway IP address for that second subnet.
- 4) Connect an external AC/DC power adapter to the Remote or Speaker Station or connect them on a Power over Ethernet (PoE) port on the Ethernet Switch.
- 5) Power up all Stations. Verify that the green LED on the HLI-ET2 port and on the Remote or Speaker Station is on.
- 6) On the Main Station, go to **Networking->Preferences->IP Address** and note the IP address of the Main Station. Make sure that **Networking->Preferences->Gateway** and **Networking->Preferences->Netmask** match that of your subnet.
- 7) On each Remote and Speaker Station make sure that all **Networking->Preferences** match that of your subnet.
- 8) On each Remote and Speaker Station go to **Networking->Link to Station->By Address** and enter the IP address of the Main Station.
- 9) Go to **Station Settings->Keyset Assign** and assign channels to any keyset.

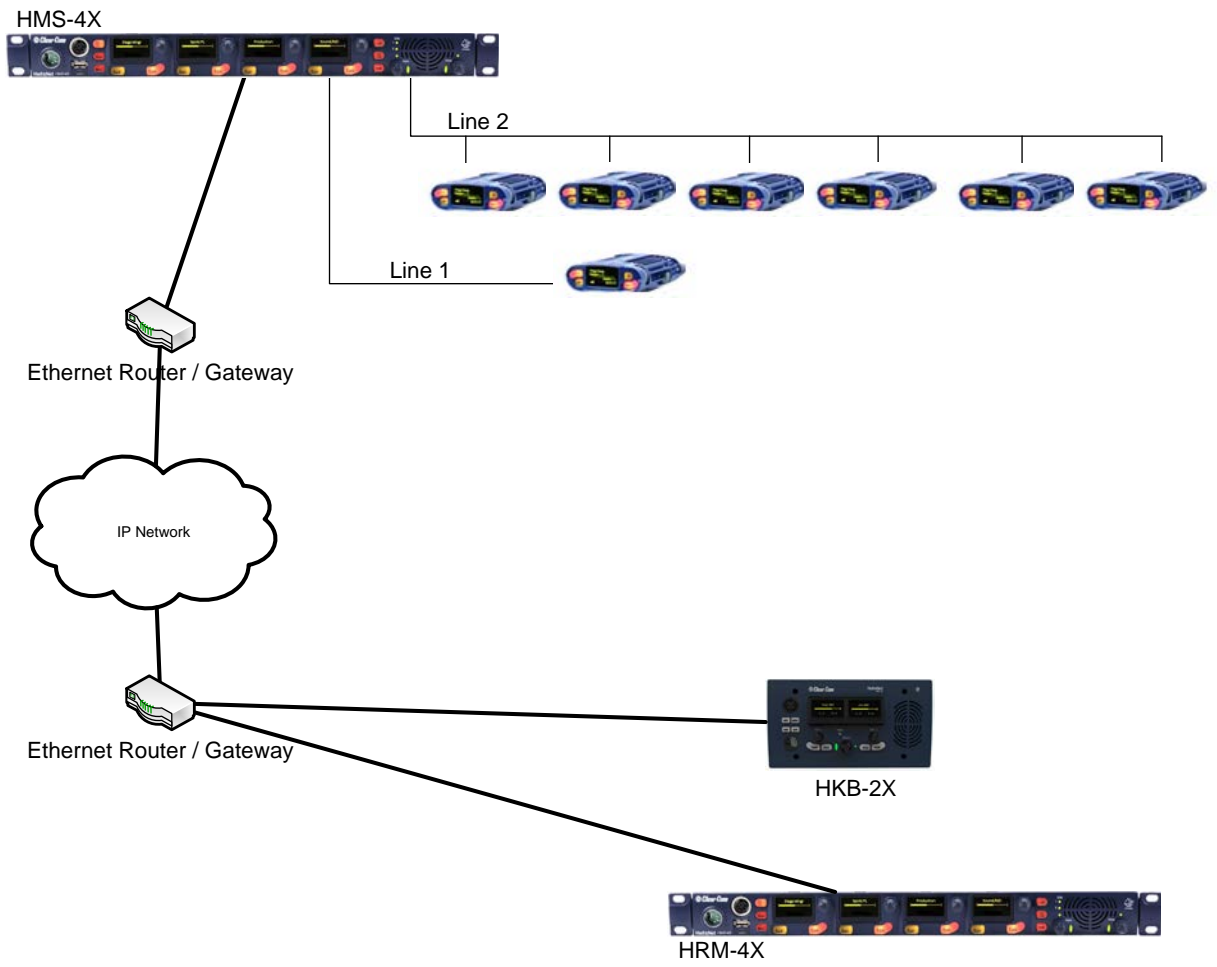

## 9.1.5 Mixed Pairs

Here is one example of how all the previous pairings could be mixed with Main Station Linking.

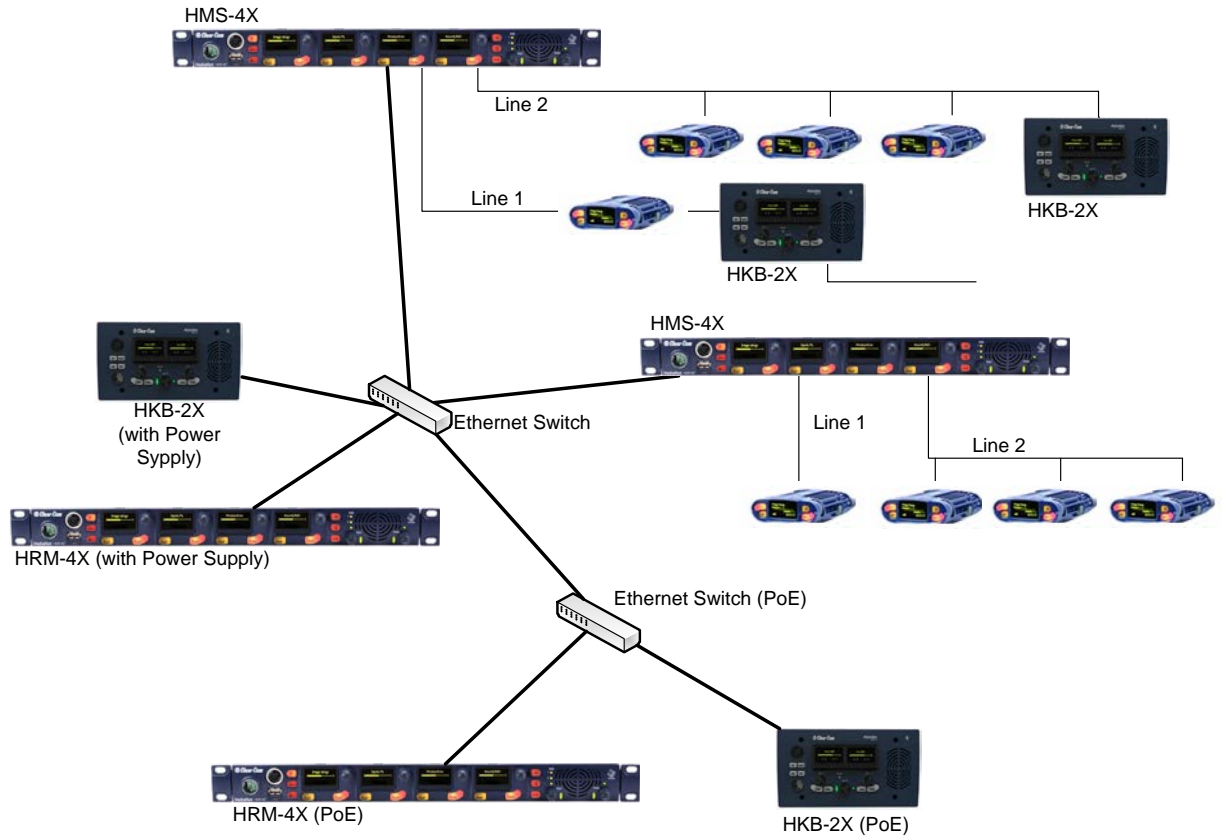

## 9.2 Networking Specifications

Specification	Value
Latency on Powerline	40-80ms (depends on the distance and the number of Devices (HBP, HRM, HKB) on the line. More distance or more Devices means more latency)
Latency over IP Network	30ms + Network Latency
Bandwidth used	HRM-4X: 600 kbps to the Main Station, 2.5 Mbps from the Main Station. HKB-2X: 300 kbps to the Main Station, 1.5 Mbps from the Main Station.
IPv4	UDP Port 6001 (Digital Intercom) TCP Port 6001 (Digital Intercom) UDP Port 5353 (mDNS)

## 10 Using the Main Station/Remote Station

---

This chapter describes how to use the Main Station/Remote Station, after your HelixNet Partyline system has been installed and configured.

For more information about integrating and using HelixNet Partyline with your existing intercom infrastructure, see **3 Installing HelixNet Partyline**.

**Tip:** For a quick reference to the functionality of the HMS-4X Main Station, the optional interface modules and the HBP-2X Beltpack, see **2 Panels and Interfaces**.

### 10.1 Using the gooseneck mic, loudspeaker and headset

To use a **gooseneck mic** to talk to connected intercom users, devices (including HBP-2X beltpacks) and systems:

- 1) Connect the gooseneck mic, using the gooseneck mic connector (3-pin female Tuchel connector) on the left of the front panel.

**Note:** For the location of the gooseneck mic connector, see  in **Table 2-3 Key to Main Station/Remote Station front panel** diagram.

- 2) To talk to other intercom users and devices:
  - a) Press the appropriate **Talk key**

When the mic (gooseneck or headset) is live, the **Mic On key** is activated automatically.

- b) Speak into the mic.

Use the front panel **loudspeaker** to listen to connected intercom users, devices and the Program Feed.

To adjust the volume level:

- 3) Adjust the volume of all incoming audio by turning the loudspeaker rotary control **[Main]**, located to the left of the loudspeaker.

Adjust the volume of the Program Feed in **relation to** the overall volume level by turning the auxiliary loudspeaker rotary control **[Prog]**, located to the right of the loudspeaker. The **Prog** volume control is subordinate to the **Main** volume control.

To increase the volume level, turn the **rotary control(s)** clockwise. To decrease the volume level, turn the **rotary control(s)** counter-clockwise.

**Note:** When you connect a headset, incoming audio is routed to the headset instead of the loudspeaker.

As you increase or decrease the volume, the level control LEDs pass through a range of indicator colors:



LED color	Volume level
Green	Low
Amber / Green	Low / Medium
Amber	Medium
Red / Amber	Medium / High
Red	High

**Table 10-1: Loudspeaker volume indicator colors**

To use a **headset** to talk and listen to connected intercom users, devices and systems:

- 1) Connect the headset, using the headset connector (4-pin XLR-M) on the far left of the front panel.

The **Headset key** is automatically activated. Incoming audio is routed to the headset instead of the loudspeaker.

**Note:** For the location of the headset connector and the headset key, see   in **Table 2-3 Key to Main Station/Remote Station front panel** diagram.

To configure audio settings for the headset, see **4.2.1 Audio settings for the headset**.

- 2) To talk to other intercom users and devices:
  - a) Press the appropriate **Talk key**.

When the microphone (gooseneck or headset) is live, the **Mic On key** is activated automatically.

- b) Speak into the microphone.

- 3) To adjust the volume level of incoming audio to the headset:
  - a) Adjust the volume of all incoming audio by turning the loudspeaker rotary control **[Main]**. The control is located to the left of the loudspeaker.
  - b) Adjust the volume of the Program Feed in **relation to** the overall volume level by turning the auxiliary loudspeaker rotary control **[Prog]**. The control is located to the right of the loudspeaker.

The **Prog** volume control is subordinate to the **Main** volume control.

### 10.1.1 Switching between the headset mic and the gooseneck mic

When both a Headset microphone and a gooseneck microphone are connected, press the **Headset key** to activate the headset mic.

Press the **Headset key** again to switch to the gooseneck mic (and deactivate the headset mic).

**Tip:** *To find out more about Clear-Com accessories, including headsets and gooseneck microphones, see <http://www.clearcom.com/product/accessories>.*

## 10.2 Entering and exiting Menu mode

Use **Menu mode** to:

- Configure the settings for the Main Station, including channel and audio settings.
- Administrate the system, monitor system performance and diagnose system issues.
- Perform software updates.

In **Menu mode**, the display screens display the four levels of menu. The menu hierarchy proceeds left to right:

- The **top level** menu is presented in the first screen (furthest left on the front panel).
- The **lowest level** menu is presented in the fourth screen (furthest right on the front panel).

To place the Main Station in **Menu mode**, press the **Menu key** to the left of the first (left) display screen. To exit Menu mode, do either of the following:

- Press the **Menu key** again.
- Wait until Menu mode times out. If you fail to press any key on the front panel for 20 seconds, the display screens revert to showing the standard channel information, see **Table 2-5 MainStation/Remote Station display icons and indicators**.

**Tip:** For more detailed information about using the Main Station menus, see **4 Configuring and managing the Main Station**.

## 10.3 Using the channel keysets

A keyset (set of controls) is located next to each of the four display screens. In operating mode, each keyset is dedicated to the control of one of the four supported intercom channels. For details of the standard on screen information for each channel, see **Table 2-5 MainStation/Remote Station display icons and indicators**.

**Note:** *To change (edit) the channel label (name), see **4.4.1 Editing the channel label**.*

*The display screens enters screensaver mode (if enabled) if the Main Station remains inactive for 10 minutes. Press any key to leave screensaver mode.*

To send a **call signal** to all the connected devices on that channel, press the **Call key**.

To **talk** to the all the devices on that channel:

- 1) Press the **Talk key**. When the gooseneck or headset mic is live, the **Mic On key** is activated automatically.

- 2) Speak into the headset or gooseneck mic (see also **10.1 Using the gooseneck mic, loudspeaker and headset**).

To **adjust the volume** of incoming audio, turn the **rotary control**. Turn the rotary control clockwise to increase the volume, and counter-clockwise to decrease volume. The current volume level is shown on screen.

To **mute** incoming audio, press the **rotary control**. The display screen displays the muted volume bar.

To **unmute** incoming audio (restoring the audio to its previous volume level), press the **rotary control** again.

**Note:** In **Menu mode**, the **rotary control** for each channel keyset is used to scroll and select menu items. For more information, see **4.1 Using the Menus**.

## 10.4 Using the All Talk key

To talk to all connected intercom users, devices and systems, **excluding** the SA (*Stage Announce*) facility:

- 1) Press the **All Talk key** to the right of the fourth (last) display screen.  
**Talk keys** for all channels are activated automatically.  
When the mic (gooseneck or headset) is live, the **Mic On key** is also activated automatically.
- 2) Speak into the headset or gooseneck mic (see also **10.1 Using the gooseneck mic, loudspeaker and headset**).

## 10.5 Using the SA [Stage Announce] key

Use the **SA [Stage Announce] key** to speak to an attached SA or Public Address system (sometimes simply a loudspeaker within the studio, theater or event area). To make a studio / public announcement:

- 1) Press the **SA key** to the right of the fourth (last) display screen.  
When the mic (gooseneck or headset) is live, the **Mic On key** is also activated automatically.
- 2) Speak into the headset or gooseneck mic (see also **10.1 Using the gooseneck mic, loudspeaker and headset**).

## 10.6 Using the RMK [Remote Mic Kill] key

**Note:** The RMK key is only present on the HelixNet Main Station. The Remote Station has instead an OPT key which is non-functional.

Use the RMK [*Remote Mic Kill*] key to:

- Send a message to all connected HelixNet Partyline devices to deselect any latched (active) **Talk keys**.
- Turn off any latched **Talk keys** on connected analog partyline beltpacks and stations.

## 10.7 Line 1 and 2 LEDs

**Note:** This section only applies to the HelixNet Main Station.

The HBP-2X beltpacks, Remote Stations and Speaker Stations are connected by one of the two lines to the Main Station.

The color of the **Line 1 and Line 2 LEDs** to the left of the front panel loudspeaker indicate the service status of each powerline:

- **Green** LED = **Ok**.
- **Amber** LED = **Busy**.
- **Red** LED = **Error**.

For more information:

- About the service status of Lines 1 and 2, see **4.8.3 Viewing powerline information and status**.
- About monitoring system performance and diagnosing system issues on the Main Station, see **4.8 Diagnostics**.

## 10.8 Line and LAN LEDs

**Note:** This section only applies to the HelixNet Remote Station and Speaker Station.

The Remote Station has a line LED that indicates the status of a powerline connection to the Main Station. The LAN LED indicates the status of the Ethernet connection, if present.

The color of the **Line and LAN LEDs** to the left of the front panel loudspeaker indicate the service status of each powerline:

- **Green** LED = **Ok**.
- **Amber** LED = **Busy**.
- **Red** LED = **Error**.



## 11 Using the HBP-2X Beltpack

---

This chapter describes how to use the **HBP-2X Beltpack**, after your HelixNet Partyline system has been installed and configured.

For more information about integrating and using HelixNet Partyline with your existing intercom infrastructure, see **13 Connecting to Other Intercom Systems**.

**Tip:** For a quick reference to the functionality of the HBP-2X Beltpack, the HMS-4X Main Station, and the optional interface modules, see **2 Panels and Interfaces**.

### 11.1 Using the beltpack keysets

The HBP-2X Beltpack supports two Partyline channels, with a separate keyset (set of controls) dedicated to the control of each channel:

- The **left-hand keyset** controls the first (top) channel displayed on screen.
- The **right-hand keyset** controls the second (bottom) channel displayed on screen.

For details of the standard on screen information for each channel, see **Table 2-5 MainStation/Remote Station display icons and indicators**.

**Note:** For more information about:

- Using the beltpack in Menu mode, see **7 Configuring and managing the HBP-2X Beltpack**.
- Changing (editing) the channel label (name), see **4.4.1 Editing the channel label**.

The display screens enters screensaver mode (if enabled) if the beltpack remains inactive for a period of time. Press any key to exit screensaver mode.

To send a **call signal** to all the connected devices (beltpacks and Main Station) on that channel, press the **Call key**.

To **talk** to all the devices connected to the channel:

- 1) Connect a headset, using the 4-pin XLR–M connector on the base / rear of the beltpack.

**Note:** For the location of the headset connector and the headset key, see **Table 2-34: Key to HBP-2X Beltpack connectors and controls (base view)**. E

- 2) Press the **Talk key**.
- 3) Speak into the headset mic.

To adjust the volume of incoming audio for a channel, turn the appropriate side-mounted **rotary control**.

Turn the rotary control clockwise to increase the volume, and counter-clockwise to decrease volume. The current volume level for the channel is shown on screen.

## 11.2 Entering and exiting Menu mode

Use **Menu mode** to:

- Configure the settings for the Main Station, including channel and audio settings.
- Monitor beltpack performance and diagnose issues.

To enter Menu mode, press the **Menu key**. To exit Menu mode, press the Menu key again.

For more information about using Menu mode on the beltpack, see **7 Configuring and managing the HBP-2X Beltpack**.

## 11.3 Adjusting the Program Feed volume level.

To adjust the listen level (volume) of the **Program Feed** to the beltpack, turn the rear / base rotary control.

Turn upwards to increase the listen level (volume), and downwards to decrease the listen level (volume).

While the listen level is adjusted, the listen level for the Program Feed replaces the standard channel information on screen.

The Main Station is used to assign the **Program Feed** to channels. For more information, see **4.4.2 Assigning the Program Listen to a channel**.

## 12 Using the Speaker Station

This chapter describes how to use the Speaker Station, after your HelixNet Partyline system has been installed and configured.

For more information about integrating and using HelixNet Partyline with your existing intercom infrastructure, see **3 Installing HelixNet Partyline**.

### 12.1 Using the gooseneck mic, loudspeaker and headset

To use a **gooseneck mic** to talk to connected intercom users, devices (including HBP-2X backpacks) and systems:

- 1) Connect the gooseneck mic, using the gooseneck mic connector (3-pin female Tuchel connector) on the left of the front panel.

**Note:** For the location of the gooseneck mic connector, see **Table 2-24 Key to Speaker Station front panel**

- 2) To talk to other intercom users and devices:

- a) Press the **Talk key**.

When the mic (gooseneck or headset) is live, the **Mic** key is activated automatically.

- b) Speak into the microphone.

Use the front panel **loudspeaker** to listen to connected intercom users, devices and the Program Feed.

To adjust the volume level:

- 3) Adjust the volume of all incoming audio by turning the loudspeaker rotary control **[Main]**, located in the center of the panel.

To increase the volume level, turn the **rotary control(s)** clockwise. To decrease the volume level, turn the **rotary control(s)** counter-clockwise.

**Note:** When you connect a headset, incoming audio is routed to the headset instead of the loudspeaker.

As you increase or decrease the volume, the level control LED passes through a range of indicator colors:

LED color	Volume level
Green	Low
Amber / Green	Low / Medium
Amber	Medium
Red / Amber	Medium / High
Red	High

Table 12-1: Loudspeaker volume indicator colors

To use a **headset** to talk and listen to connected intercom users, devices and systems:

- 4) Connect the headset, using the headset connector (4-pin XLR–M) on the far left of the front panel.

The **Headset key** is automatically activated. Incoming audio is routed to the headset instead of the loudspeaker.

**Note:** For the location of the headset connector and the headset key, see **Table 2-24 Key to Speaker Station front panel** Table 2-3 Key to Main Station/Remote Station front panel diagram.

To configure audio settings for the headset, see **6.2.1 Audio settings for the headset**

- 5) To talk to other intercom users and devices:

- a) Press the appropriate **Talk key**.

When the microphone (gooseneck or headset) is live, the **Mic key** is activated automatically.

- b) Speak into the microphone.

- 6) To adjust the volume level of incoming audio to the headset:

- a) Adjust the volume of all incoming audio by turning the loudspeaker rotary control **[Main]**. The control is located to the left of the loudspeaker.

- b) Adjust the volume of the Program Feed using the **PGM** rotary control.

### 12.1.1 Switching between the headset mic and the gooseneck mic

When both a Headset microphone and a gooseneck microphone are connected, press the **Headset key** to activate the headset microphone, and press the **Mic** key to activate the microphone.

**Tip:** *To find out more about Clear-Com accessories, including headsets and gooseneck microphones, see <http://www.clearcom.com/product/accessories>.*

## 12.2 Entering and exiting Menu mode

Use **Menu mode** to:

- Configure the settings for the Speaker Station, including channel and audio settings.
- Administrate the system, monitor system performance and diagnose system issues.

In **Menu mode**, the display screens display the four levels of menu. The menu hierarchy proceeds left to right:

- The **top level** menu is presented in the first screen (left on the front panel).
- The **second level** menu is presented in the second screen (right on the front panel).

To place the Speaker Station in **Menu mode**, press the **Menu key** to the left of the first (left) display screen. To exit Menu mode, do either of the following:

- Press the **Menu key** again.
- Wait until Menu mode times out. If you fail to press any key on the front panel for 20 seconds, the display screens revert to showing the standard channel information:
  - Channel label (name).
  - Listen (volume) level.

**Tip:** For more detailed information about using the Main Station menus, see **6 Configuring and managing the Speaker Station**.

## 12.3 Using the channel keysets

A keyset (set of controls) is located beneath each of the display screens. In operating mode, each keyset is dedicated to the control of one of the four supported intercom channels. Use the **Shift** key to toggle between channels 1-2 and channels 3-4. For details of the standard on screen information for each channel, see **Table 2-5 MainStation/Remote Station display icons and indicators**.

*The display screens enters screensaver mode (if enabled) if the Speaker Station remains inactive for 10 minutes. Press any key to leave screensaver mode.*

To send a **call signal** to all the connected devices (beltpacks) on that channel, press the **Call key**.

To **talk** to all the devices on that channel:

- 1) Press the **Talk key**. When the mic (gooseneck or headset) is live, the **Mic** is activated automatically.
- 2) Speak into the headset or gooseneck mic (see also **10.1 Using the gooseneck mic, loudspeaker and headset**).

To **adjust the volume** of incoming audio, turn the **rotary control**. Turn the rotary control clockwise to increase the volume, and counter-clockwise to decrease volume. The current volume level is shown on screen.

To **mute** incoming audio, press the **rotary control**. The display screen displays the muted volume bar.

To **unmute** incoming audio (restoring the audio to its previous volume level), press the **rotary control** again.

**Note:** In **Menu mode**, the **rotary control**] for each channel keyset is used to scroll and select menu items. For more information, see **4.1 Using the Menus**.

## 12.4 Line and LAN LEDs

The Speaker Station has a line LED that indicates the status of a powerline connection to the Main Station. The LAN LED indicates the status of the Ethernet connection, if present.

The color of the **Line and LAN LEDs** to the left of the front panel loudspeaker indicate the service status of each powerline:

- **Green** LED = **Ok**.
- **Amber** LED = **Busy**.
- **Red** LED = **Error**.

## 13 Connecting to Other Intercom Systems

---

This chapter provides basic guidance on connecting your HelixNet Partyline system to a range of other intercom systems, including:

- Two-wire cabled partyline systems (RTS and Clear-Com Encore®).
- Two-wire / four-wire wireless systems (Tempest, CellCom® / FreeSpeak®, and the DX210).
- Digital matrix systems (Eclipse® MVX four-wire).
- Two way radio systems.

The HMX-4X Main Station is connected to these systems using the optional Two-wire and Four-wire interface modules.

### 13.1 Connecting HelixNet Partyline to Encore®

#### 13.1.1 About Encore

Encore is the plug-and-play analog two-wire partyline system from Clear-Com.

Clear-Com Encore is widely used in theaters, schools, local broadcast stations, churches and other small to mid-size live productions.

Two and four channel versions of the Encore Main Stations and Remote Stations are available.

**Tip:** For more information about Encore, see your **Encore documentation** or visit the **Analog Partyline Intercom** pages on the Clear-Com website:  
<http://www.clearcom.com/product/partyline>.

### 13.1.2 Quick reference: Connecting to Encore

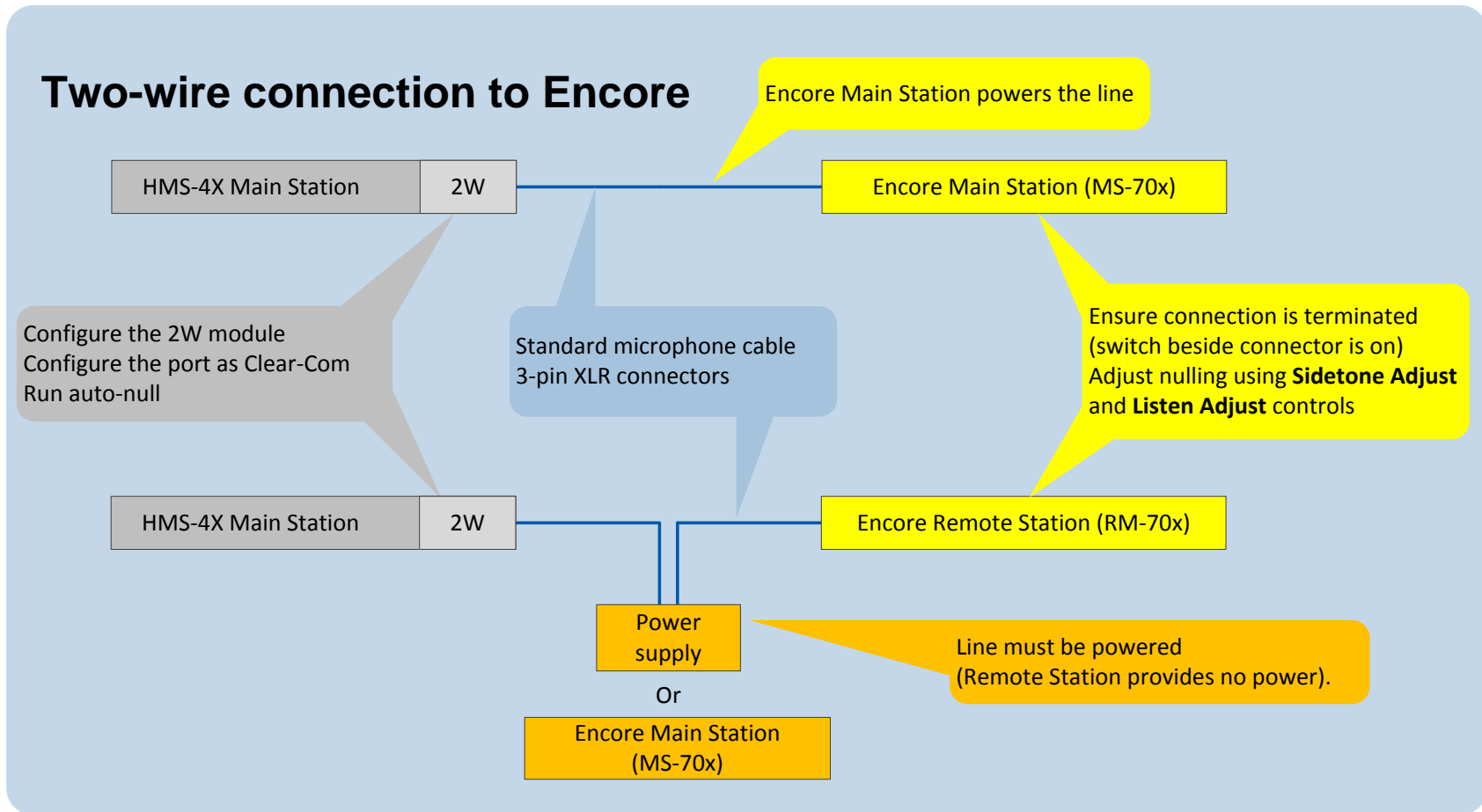

Figure 13-1: Two-wire connection to Encore



### 13.1.3 Connecting to an Encore Main Station

**Note:** The following procedure assumes that a two-wire interface module has been fitted to the HMS-4X Main Station. For more information about interface modules, see **2.2.1 HMS-4X Main Station rear panel: Interface modules**.

**Note:** A HelixNet system with HLI-2W2 must be able to receive power from an analog partyline.

To connect your HelixNet Partyline system to an Encore Main Station (for example, the four channel **MS-704**):

- 1) On the HMS-4X Main Station, configure the **Module Settings** for the two-wire interface module (**Menu mode > Module Settings**). For the full procedure, see **4.6.2 Configuring a Two-wire interface module**.

**Note:** Check that the two-wire module is configured for **Clear-Com systems** (the default) and run the **Auto-null**. Auto-nulling helps to reduce echo while talking on a two-wire audio system. You must run auto-null every time you change the cabling.

- 2) Physically connect the HMS-4X Main Station to the Encore Main Station, using the 3-pin XLR connectors:

- On the HMS-4X Main Station two-wire interface module.
- On the back panel (rear) of the Encore Main Station.

There are four channels (A, B, C and D), comprising two 3-pin XLR connectors, on the MS-704.

Connect to the selected channel using standard microphone cabling.

**Note:** The Two-wire module will not function without an attached power supply on the analog side of the interface.

Ensure that the connection is terminated (using the termination switch beside the connectors). The default position for the switch is **on**.

- 3) On the Encore (MS-704) Main Station, adjust nulling for the selected channel (either channel A, B, C or D on the MS-704). Nulling helps to reduce echo while talking on a two-wire audio system.

**Tip:** The amount of null that is required changes when you add or remove devices, or alter the length of the cabling. For optimum performance, Clear-Com recommends that you adjust the nulling every time you make a change to the system configuration.

**Note:** Ensure that **all** Talk keys/routes are disabled before auto-nulling commences.

To adjust nulling on a channel on the Encore Main Station (MS-704):

- a) Turn the screwdriver-adjustable **Sidetone Adjust** control (just below the headset connector) to the appropriate level.
- b) Turn the screwdriver-adjustable **Listen level** control (the null control, located just below the channel **Talk** button and **Call** LED) for the channel to the appropriate level.

**Tip:** If the headset microphone is being used, hum or gently scratch the mic for a continuous signal source to null on. If a good null is not attainable, switch the **Long / Short DIP switch** for the channel to its opposite setting. Use the setting that produces the best audio quality.

To optimize audio quality, you may also want to adjust the **Audio Settings** on the HMS-4X Main Station. For more information, see **4.2 Configuring the Audio settings**.

### 13.1.4 Connecting to Encore remote stations

Connecting to an Encore remote station (for example, the RM-704) is similar to connecting to an Encore Main Station (see **13.1.2 Quick reference: Connecting to Encore**).

You will require a **separate power supply**, for example, the PS-702 (two channel) or PS-704 (four channel) power supply, to power the remote station which is unpowered and any connected wired beltpacks.

## 13.2 Connecting HelixNet Partyline to RTS (Telex) two-wire systems

### 13.2.1 About RTS two-wire systems

HelixNet Partyline is also designed for interoperability with RTS (Telex) TW (two-wire) analog partyline systems from Telex.

RTS two-wire systems include fully programmable intercom (main) stations, remote speaker stations, two-wire beltpacks, and two-wire power supplies.

## 13.2.2 Quick reference: Two-wire connection to RTS 2W system

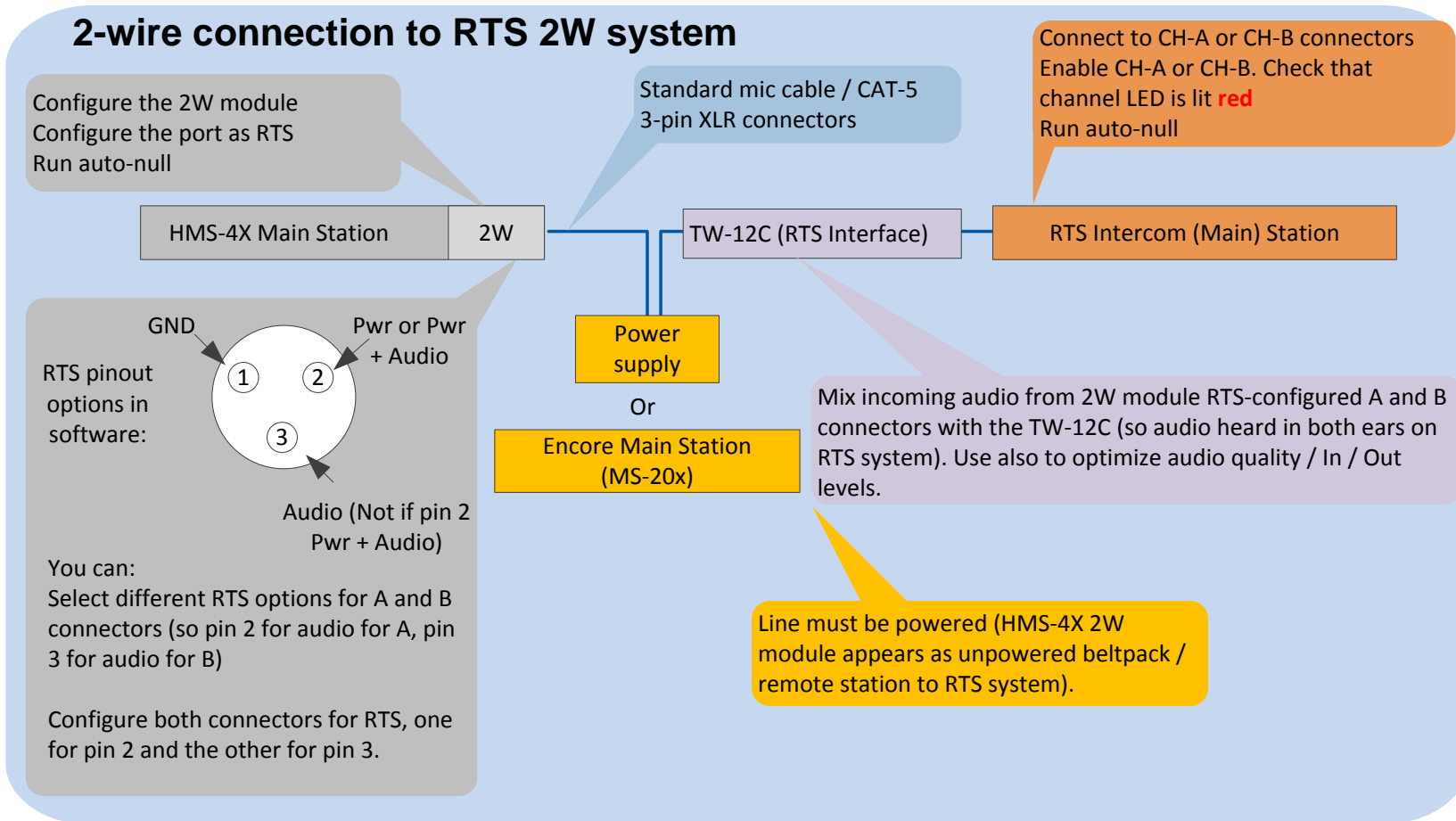

Figure 13-2: Two-wire connection to RTS 2W system

### 13.2.3 Connecting to an RTS (Telex) intercom station

To connect your HelixNet Partyline system to an RTS intercom station (in this case, the 2 channel MCE325 user station):

- 1) On the HMS-4X Main Station, configure the **Module Settings** for the two-wire interface module.

For the full procedure, see **4.6.2 Configuring a Two-wire interface module**.

Ensure that you:

- **Configure port(s) for RTS systems.** You can select from two different pinouts when connecting to an RTS two-wire system:

RTS pinout option	Description
RTS Audio Pin 2	Pin 2 is used for both power and audio.
RTS Audio Pin 3	Pin 3 is used for audio (Pin 2 is used for power only).

**Table 13-1: Configuring Module Settings: RTS pinout options**

- **Run auto-null.** Auto-nulling helps to reduce echo while talking on a two-wire audio system. You must run auto-null every time you change the cabling.
- 2) Physically connect the HMS-4X Main Station to the RTS intercom station (MCE325). The two channels of RTS TW intercom must be split prior to connection with either of the Two-wire module ports. RTS Audio Pin 2 carries the power that is required for the Two-wire module.

Powering the connection:

You must power the connection between the systems using either a dedicated power supply (such as the PK-7, PS-702, or PS-704), or a powered Encore Main Station (such as the MS-702 or MS-704) or an RTS power supply.

**Tip:** For more information about the PK-7 or PS-70x power supply devices from Clear-Com, see <http://www.clearcom.com/product/partyline/power-supplies>

Connecting to the MCE325 device:

There are three 3-pin XLR connectors on the rear panel of the MCE325 device. In two-wire mode:

- The left and right-hand connectors are used for intercom channels 1 and 2 input/ output.
- The center connector is used for channels 3 and 4 input / output.
- Connect to the selected channel using standard microphone cabling.

**Note:** The MCE325 is designed for use with intercom lines with a 200-ohm line terminating impedance. A 200 ohm termination plug is connected to the center 3-pin XLR connector to prevent channels 3 and 4 from oscillating when the MCE325 is in two-channel mode.

- 3) On the RTS device (in this case, the MCE325), adjust the nulling (if necessary) on the channel to which the HMS-4X Main Station is connected.

Nulling helps to reduce echo while talking on a two-wire audio system. A **sidetone nulling trimmer** (control) is provided for each of the four channels on the device.

To adjust a sidetone nulling trimmer:

- a) Turn the speaker switch on (even if an external speaker is not connected). This turns off the internal sidetone trimmer, which controls the sidetone level in headsets.
- b) Turn on the microphone. Activate the relevant **Talk** button and speak into the microphone.
- c) To minimize echo, adjust the **sidetone nulling trimmer** (located under the **CH1** and **CH2** rotary controls).

**Note:** The default setting for each trimmer is for maximum nulling of the microphone signal when a 200-ohm resistance terminates the channel. However, you may have to adjust the nulling according to the system configuration.

## 13.3 Connecting HelixNet Partyline to Tempest®

### 13.3.1 About Tempest

Tempest is a digital wireless intercom system, comprising a basestation (Main Station) and beltstations (beltpacks). There are two-wire and four-wire versions of Tempest available. The system operates in either:

- The 2.4GHz ISM band (Tempest 2400 models).
- The 900 MHz ISM band (Tempest 900 models).

**Tip:** For more information about Tempest, see your Tempest documentation or visit the wireless intercom pages on the Clear-Com website: <http://www.clearcom.com/product/wireless>.

### 13.3.2 Quick reference: Two-wire connection to Tempest

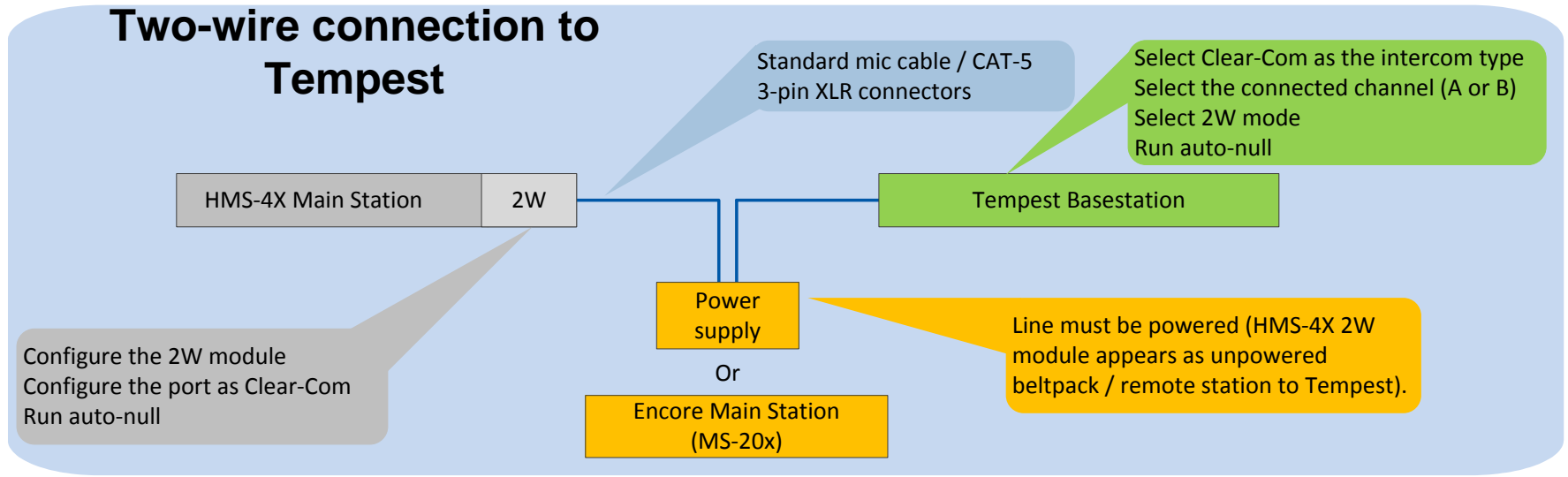

Figure 13-3: Two-wire connection to Tempest

### 13.3.3 Two-wire connection to Tempest

To connect your HelixNet Partyline system to Tempest, using a two-wire connection:

- 1) On the HMS-4X Main Station, configure the **Module Settings** for the two-wire interface module.

For the full procedure, see **4.6.2 Configuring a Two-wire interface module**.

**Note:** Check that the Two-wire module is configured for **Clear-Com systems** (the default) and run **Auto-null**. Auto-nulling helps to reduce echo while talking on a two-wire audio system. You must run auto-null every time you change the cabling.

- 2) On the Tempest base station:
  - a) Select **Clear-Com** as the intercom type, using the slide switch on the front panel.
  - b) Configure an intercom channel for two-wire connection:
    - i. Select the intercom channel (A or B), using the **CHAN** selection button on the front panel.
    - ii. Select two-wire connection for the intercom channel, using the **two-wire / four-wire** selection button on the front panel.
  - c) Enable **Auto-null**, using the Tempest menu screens. Enable **Manual Null** to remove any residual echo, where desired.

For more detailed information about setting up a two-wire connection on the Tempest basestation, see your **Tempest reference manual**.



**Always** set the intercom type before you connect a two-wire intercom system to the Tempest Basestation.

**Never** change the setting while the systems are connected. Changing the setting while the systems are connected can damage the Tempest Basestation and / or the other system (in this case, HelixNet Partyline).

- 3) Physically connect the HelixNet Partyline and Tempest systems.

**Powering the connection:**

Tempest has a Master Mode setting that supplies power to the two-wire connection. In this case, no external power supply is required. Otherwise, you must power the connection between the systems using either a dedicated power supply (such as the PK-7, PS-702, or PS-704), or a powered Encore Main Station (such as the MS-702 or MS-704).

**Tip:** For more information about the PK-7 or PS-70x power supply devices from Clear-Com, see <http://www.clearcom.com/product/partyline/power-supplies>

**Connecting to Tempest:**

You can use standard microphone cable or CAT5 cable types to connect the HMS-4X Main Station to the Tempest Basestation. 3-pin XLR connectors are located:

- On the HMS-4X Main Station two-wire interface module.
- On the back panel (rear) of the Tempest Basestation.

**Tip:** Tempest provides two-wire input/output gain adjustments, and can be utilized to either balance the gains between HelixNet and Tempest or connect two-wire system interfaces through a Tempest base station.

- 4) Adjust the **In / Out** volume level controls on the Tempest Basestation. The **In / Out** volume levels have the following ranges:

Volume level	Range
In	-18dB to +4dB
Out	-18dB to +4dB

**Table 13-2: Tempest Basestation In / Out volume levels**

For more information, see your *Tempest reference manual*.

**Tip:** To optimize audio quality, you may also want to adjust the **Audio Settings** on the HMS-4X Main Station. For more information, see **4.2 Configuring the Audio settings**.



### 13.3.4 Quick reference: Four-wire connection to Tempest

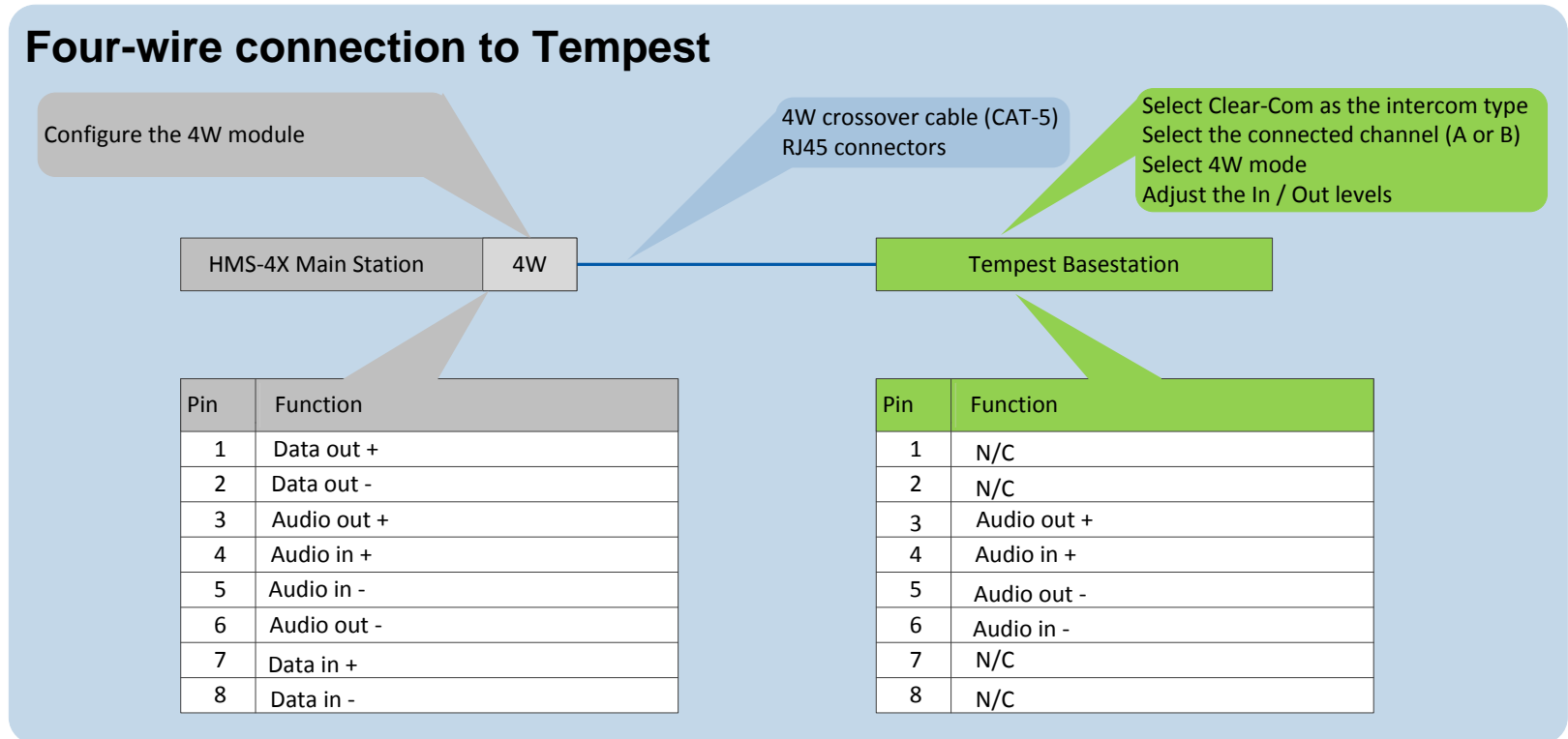

Figure 13-4: Four-wire connection to Tempest

### 13.3.5 Four-wire connection with Tempest

To connect your HelixNet Partyline system with Tempest, using a four-wire connection:

- 1) On the HMS-4X Main Station, configure the **Module Settings** for the Four-wire interface module, see **4.6.1 Configuring a Four-wire interface module**.
- 2) On the Tempest Basestation, configure an intercom channel for four-wire connection:
  - a) Select the intercom channel (**A** or **B**), using the **CHAN** selection button on the front panel.
  - b) Select four-wire connection for the intercom channel, using the **two-wire / four-wire** selection button on the front panel.
- 3) Connect the HMS-4X Main Station and the Tempest Basestation, using four-wire crossover CAT5 cabling.

**Note:** For pinout information for the two systems, see the **quick reference diagram** in **13.3.4. Quick reference: Four-wire connection to Tempest**.

RJ45 connectors are located:

- On the HMS-4X Main Station four-wire interface module.
  - On the back panel (rear) of the Tempest Basestation (the top RJ45 connector is for **intercom channel A** and the bottom RJ45 connector for **intercom channel B**).
- 4) Adjust the **In / Out** levels controls on the Tempest Basestation, where necessary.

For more information, see your **Tempest reference manual**.

**Tip:** To optimize audio quality, you may also want to adjust the **Audio Settings** on the HMS-4X Main Station. For more information, see **4.2 Configuring the Audio settings**.

## 13.4 Connecting HelixNet Partyline to CellCom<sup>®</sup> / FreeSpeak<sup>®</sup>

### 13.4.1 About CellCom / FreeSpeak

CellCom / FreeSpeak is a wireless intercom system from Clear-Com, operating within the license-free 1.92-1.93GHz frequency band. The system is branded as CellCom in North America and as FreeSpeak in the rest of the world.

CellCom /FreeSpeak combines DECT and wireless auto-roaming technologies to allow users to move freely without losing communication connection. Active Antennas enable a beltpack-to-basestation distance range of up to 3200ft (1000m).

You can connect up to 20 full-duplex wireless beltpacks (which operate as fully programmable mobile panels) to one CellCom / FreeSpeak basestation (Main Station).

**Note:** CellCom / FreeSpeak can also operate as an integrated solution, with up to 35 beltpacks connected to a Clear-Com digital Matrix frame.

**Tip:** For more information about CellCom / FreeSpeak, see your CellCom / FreeSpeak documentation or visit the wireless intercom pages on the Clear-Com website: <http://www.clearcom.com/product/wireless>.

## 13.4.2 Quick reference: Two-wire connection to CellCom / FreeSpeak

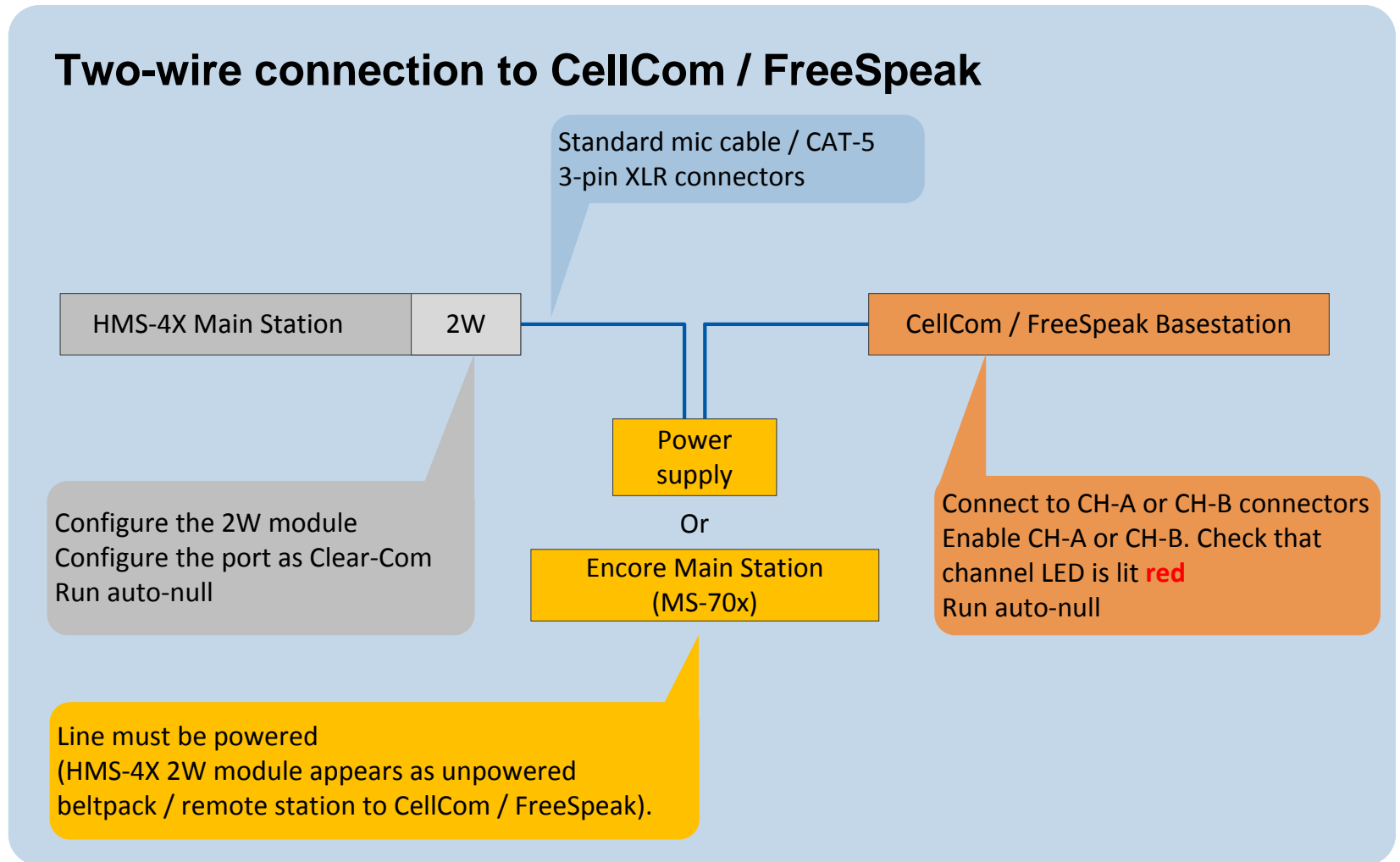

Figure 13-5: Two-wire connection to CellCom / FreeSpeak

### 13.4.3 Two-wire connection to CellCom / FreeSpeak

To connect your HelixNet Partyline system to a CellCom / FreeSpeak basestation (Main Station), using a two-wire connection:

- 1) On the HMS-4X Main Station, configure the **Module Settings** for the two-wire interface module. See **4.6.2 Configuring a Two-wire interface module**.  
**Note:** Check that the two-wire module is configured for **Clear-Com systems** (the default) and enable **Auto-nulling**. Auto-nulling helps to reduce echo while talking on a two-wire audio system.
- 2) There are two partyline channels on the CellCom / FreeSpeak basestation (**CH-A** and **CH-B**). Before connecting the HMS-4X Main Station to the basestation, ensure that the partyline LED on the front panel for the selected channel is **off**.

**Off** indicates that the partyline connection is currently disabled from the basestation.

**Note:** If the channel is currently enabled, the partyline LED is lit **red**.

- 3) Physically connect the HMS-4X Main Station to one of the two partyline channels on the CellCom / FreeSpeak basestation (Main Station).

#### Powering the connection:

You must power the connection between the systems using either a dedicated power supply (such as the PK-7, PS-702, or PS-704), or a powered Encore Main Station (such as the MS-702 or MS-704).

**Tip:** For more information about the PK-7 or PS-70x power supply devices from Clear-Com, see <http://www.clearcom.com/product/partyline/power-supplies>

#### Connecting the systems:

Use standard microphone cable to connect the two systems. There are 3-pin XLR connectors:

- On the HMS-4X Main Station two-wire interface module.
  - On the back panel of the CellCom / FreeSpeak Basestation. Two 3-pin XLR connectors, one male, one female, are provided for each of the two partyline channels (**CH-A** and **CH-B**).
- 4) On the CellCom / FreeSpeak basestation, press **Enable** on the front panel (located directly beneath the LED for the connected channel (**CH-A** or **CH-B**)). The LED for the channel is lit **red**.  
The basestation automatically detects and configures the appropriate power and termination settings when the channel is enabled. The basestation also remembers that the channel is enabled the next time the basestation is powered up.
  - 5) On the CellCom / FreeSpeak basestation, press **Enable** again and **hold**. The basestation activates auto-nulling on the connected channel. Auto-nulling helps to reduce echo while talking on a two-wire audio system.

### 13.4.4 Quick reference: Four-wire connection to CellCom / FreeSpeak

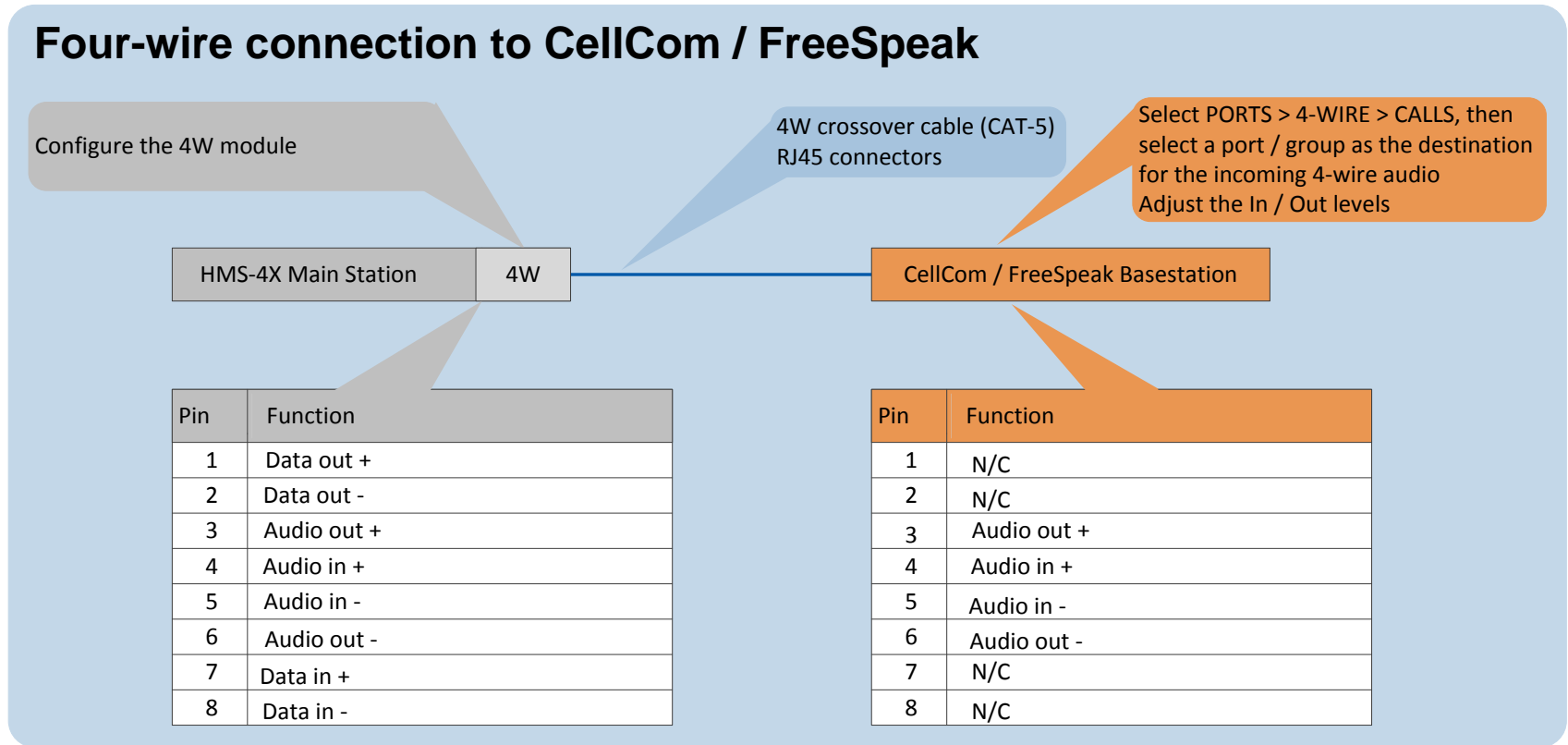

Figure 13-6: Four-wire connection to CellCom / FreeSpeak

## 13.4.5 Four-wire connection to CellCom / FreeSpeak

To connect your HelixNet Partyline system with a CellCom / FreeSpeak basestation (Main Station), using a four-wire connection:

- 1) On the HMS-4X Main Station, configure the **Module Settings** for the four-wire interface module. For the procedure, see **4.6.1 Configuring a Four-wire interface module**.
- 2) Connect the HMS-4X Main Station and the CellCom / FreeSpeak basestation, using four-wire crossover CAT5 cabling.

**Note:** For pinout information for the two systems, see the **quick reference diagram** in **13.4.4 Quick reference: Four-wire connection to CellCom / FreeSpeak**.

RJ-45 connectors are located:

- On the HMS-4X Main Station four-wire interface module.
  - On the back panel (rear) of the CellCom / FreeSpeak basestation. There are four RJ45 connectors for four-wire connections on the basestation.
- 3) Adjust the **In / Out** volume levels, using the CellCom / FreeSpeak front panel display. For more information, see your **CellCom / FreeSpeak documentation**.

**Tip:** To optimize audio quality, you may also want to adjust the **Audio Settings** on the HMS-4X Main Station. For more information, see **4.2 Configuring the Audio settings**.

## 13.5 Connecting HelixNet Partyline to the DX210

### 13.5.1 About the DX210

The Clear-Com HME DX210 is a 2 channel wireless intercom system. The basestation (Main Station) supports up to 15 beltacks or all-in-one headsets (headsets operating as beltacks).

The DX210 supports Clear-Com and RTS cabled two-wire intercom systems, and also has four-wire and auxiliary audio connections.

The DX210 operates in the license-free 2.4GHz band, and has provisions for spectrum-friendly co-existence with other devices in the same band.

**Tip:** For more information about the DX210, see your DX210 documentation or visit the wireless intercom pages on the Clear-Com website: <http://www.clearcom.com/product/wireless>.

## 13.5.2 Quick reference: Two-wire connection to DX210

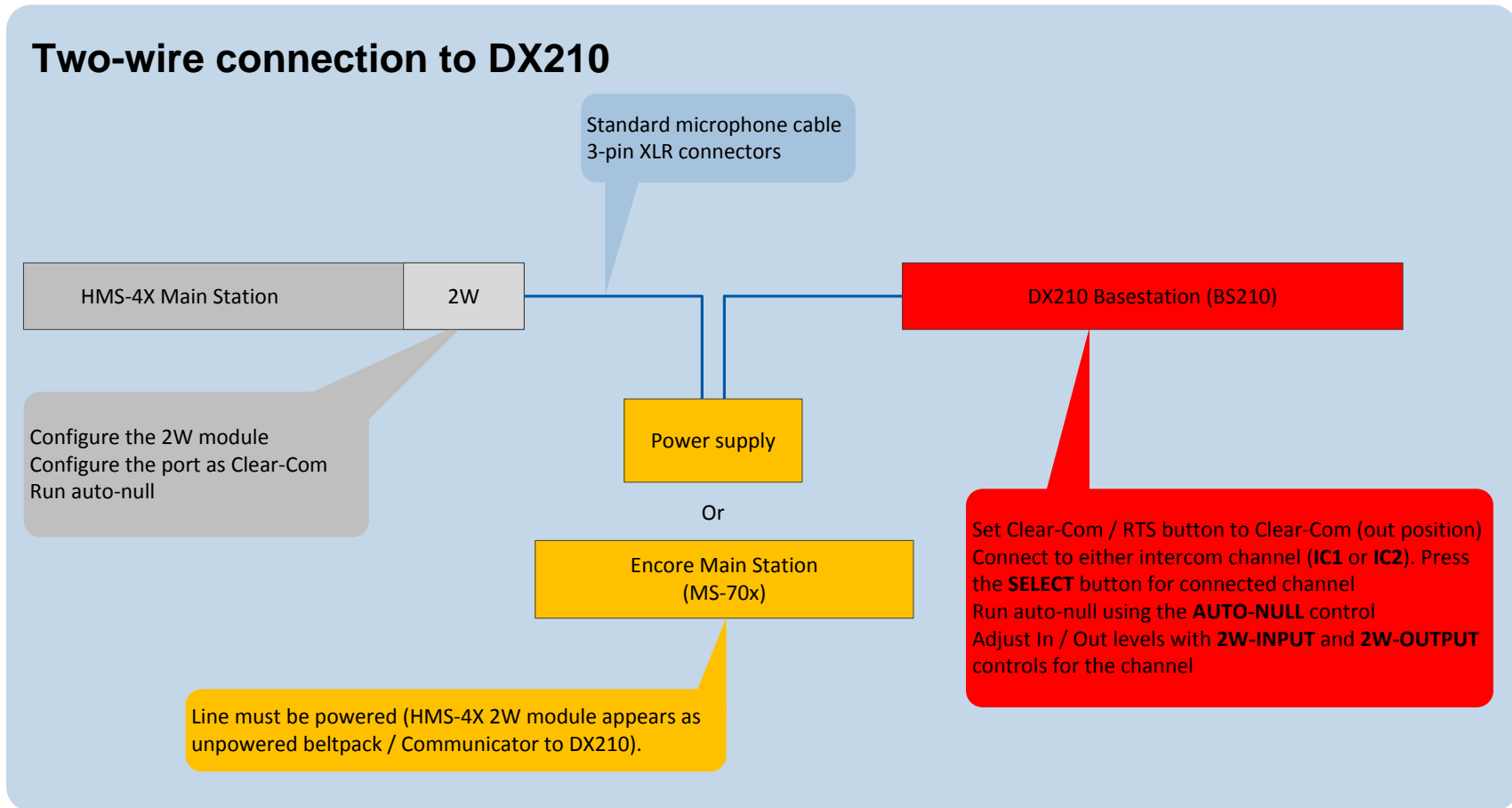

Figure 13-7: two-wire connection to DX210



### 13.5.3 Two-wire connection to the DX210

To connect your HelixNet Party-line system to the DX210 basestation (Main Station), using a two-wire connection:

- 1) On the HMS-4X Main Station, configure the **Module Settings** for the Two-wire interface module. For the procedure, see **4.6.2 Configuring a Two-wire interface module**.  
**Note:** Check that the two-wire module is configured for **Clear-Com systems** (the default) and run **Auto-null**. Auto-nulling helps to reduce echo while talking on a two-wire audio system. You must run auto-null every time you change the cabling.
- 2) On the rear panel of the DX210 basestation, ensure that the **Clear-Com / RTS** button is set to **Clear-Com** mode (the **out position**).
- 3) Physically connect the HMS-4X Main Station to one of the two intercom channels on the DX210 basestation (Main Station).

#### Powering the connection:

You must power the connection between the systems using either a dedicated power supply (such as the PK-7, PS-702, or PS-704), or a powered Encore Main Station (such as the MS-702 or MS-704).

**Tip:** For more information about the dedicated power supply devices (PK-7 or PS-70x devices) from Clear-Com, see <http://www.clearcom.com/product/partyline/power-supplies>

#### Connecting the systems:

Use standard microphone cable to connect the two systems. 3-pin XLR connectors are located:

- On the HMS-4X Main Station two-wire interface module.
- On the back panel (rear) of the DX210 basestation.

Two 3-pin XLR connectors (one male, one female) are provided for each of the two intercom channels (**IC1** and **IC2**) on the basestation.

- 4) On the front panel of the DX210 basestation, press the **SELECT** button for the connected intercom channel (either **IC1** or **IC2**).

The **2-W** (two-wire) LED next to the **SELECT** button is lit **green**.

**Note:** If power is **not** detected at the connector, the **2-W** LED is lit **red**. No audio can be transmitted between the systems. When the HMS-4X Main Station is powered, power is supplied to the connection and the **2-W** LED is lit **green**.

- 5) Apply auto-nulling to the connected channel (either IC1 or IC2) on the DX210 basestation. Auto-nulling helps to reduce echo while talking on a two-wire audio system. To apply auto-nulling:
  - a) Insert a pen or similar pointed object into the **AUTO-NULL** hole on the front panel.
  - b) Press and hold **AUTO-NULL** for 2 seconds.

**Note:** Before applying auto-nulling, ensure that there are no open microphones on the wired intercom. If users are wearing headsets, you must notify them of the audio-sweep that precedes the application of auto-nulling.

- 6) Adjust the two-wire intercom receive and send levels (in / out levels), using the **2-W INPUT** and **2-W OUTPUT** controls for the connected channel (**IC1** or **IC2**) on the DX210 basestation front panel. For more information, see your **DX210 documentation**.

**Tip:** To optimize audio quality, you may also want to adjust the **Audio Settings** on the HMS-4X Main Station. For more information, see **4.2 Configuring the Audio settings**.

## 13.5.4 Quick reference: Four-wire connection to DX210

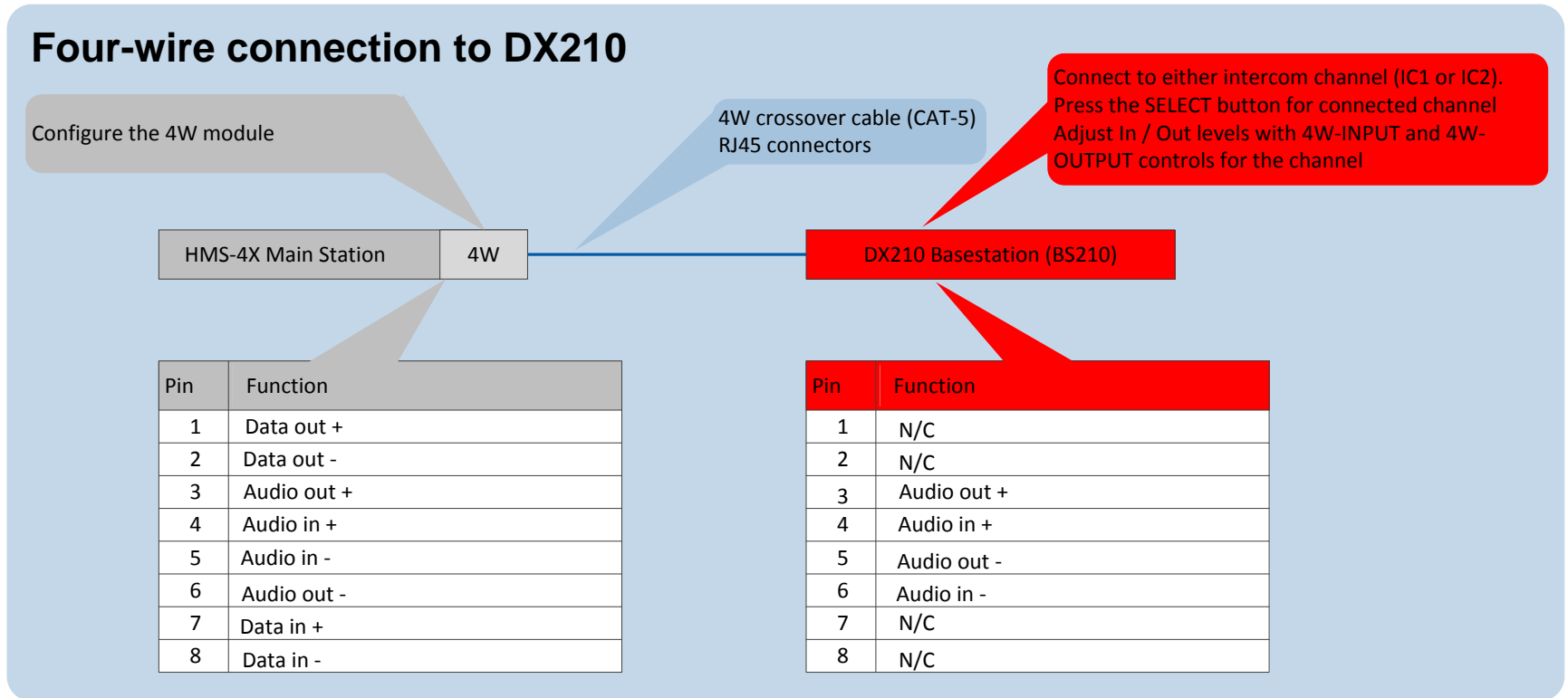

Figure 13-8: Four-wire connection to DX210

## 13.5.5 Four-wire connection to the DX210

To connect your HelixNet Partyline system with a DX210 basestation (BS210), using a four-wire connection:

- 1) On the HMS-4X Main Station, configure the **Module Settings** for the Four-wire interface module. See **4.6.1 Configuring a Four-wire interface module**.
- 2) Connect the HMS-4X Main Station and the DX210 basestation (BS210), using four-wire crossover CAT5 cabling.

**Note:** For pinout information for the two systems, see the **quick reference diagram** in **13.5.4 Quick reference: Four-wire connection to DX210**.

RJ45 connectors are located:

- On the HMS-4X Main Station Four-wire interface module.
- On the back panel (rear) of the DX210 basestation (BS210).

There is an RJ45 (four-wire) connector for each of the intercom channels on the DX210 base station (**IC1** and **IC2**). Connect the systems with a four-wire crossover CAT5 cable.

- 3) Adjust the **In / Out** volume levels, using the CellCom / FreeSpeak front panel display. For more information, see your **CellCom / FreeSpeak documentation**.

**Tip:** To optimize audio quality, you may also want to adjust the **Audio Settings** on the HMS-4X Main Station. For more information, see **4.2 Configuring the Audio settings**

## 13.6 Connecting HelixNet Partyline to Eclipse®

### 13.6.1 About Eclipse

Eclipse is the digital matrix system from Clear-Com. A wide choice of system frames, system cards and modules enables the unification of multiple intercom systems (digital, analog, wired and wireless) in a single intercoms infrastructure.

Eclipse is configured, managed and maintained using the intuitive Eclipse Configuration Software (EHX). The Production Maestro® software provides a centralized routing tool, to assist with four-wire configurations. Logic Maestro is a graphical programming tool for ECS, simplifying the design and programming of complex logical functions.

The following procedures reference the following Eclipse devices:

- **The Eclipse or Eclipse-HX system frame.** For example, the Eclipse Median is a 6RU frame that houses 2 CPU and 7 matrix slots with 8 built-in interface module slots.
- **The CCI-22 interface module.** The CCI-22 is the two-wire party-line interface (Clear-Com and / or RTS) to Eclipse. ECS views a direct, four-wire HelixNet Party-line connection with the system frame as a 'virtual' CCI-22 connection.

**Tip:** For more information about Eclipse, see your Eclipse / EHX documentation or visit the digital matrix pages on the Clear-Com website: <http://www.clearcom.com/product/digital-matrix>.

## 13.6.2 Quick reference: Two-wire connection to Eclipse

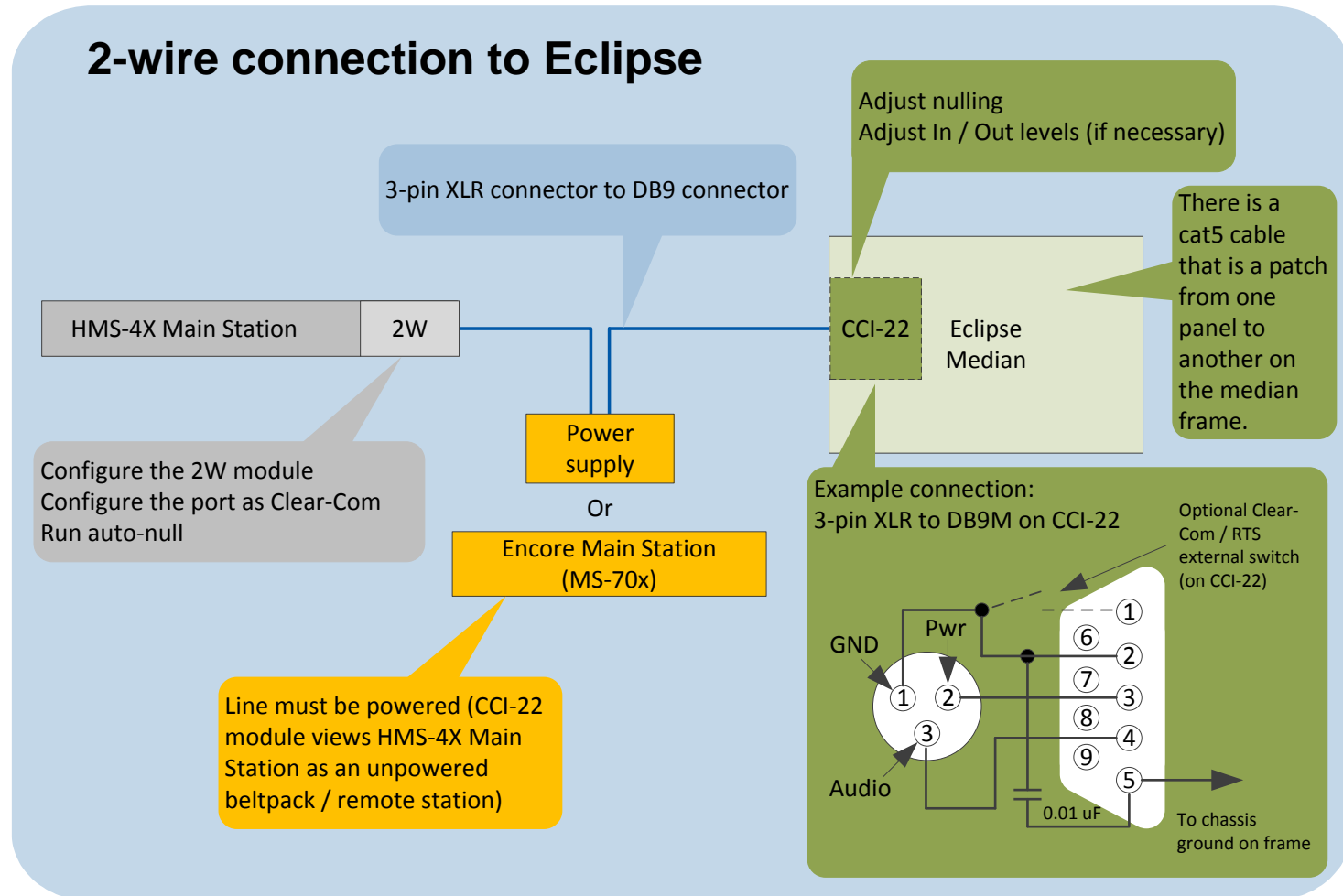

Figure 13-9: Two-wire connection to an Eclipse Matrix

### 13.6.3 Two-wire connection to an Eclipse or Eclipse-HX system frame

To connect your HelixNet Partyline system to an Eclipse or Eclipse-HX System, using a two-wire connection:

- 1) On the HMS-4X Main Station, configure the **Module Settings** for the Two-wire interface module. For the procedure, see **4.6.2 Configuring a Two-wire interface module**.

**Note:** Check that the two-wire module is configured for **Clear-Com systems** (the default) and run **Auto-null**. Auto-nulling helps to reduce echo while talking on a two-wire audio system. You must run auto-null every time you change the cabling.

- 2) Physically connect the HMS-4X Main Station to the CCI-22 dual-channel party-line interface module.

The CCI-22 may be fitted:

- Directly to an Eclipse or Eclipse-HX System.
- An interface frame (such as the IMF-3 or IMF-102), connected to the Eclipse matrix.

**Tip:** For more information about installing and using the CCI-22, see the CCI-22 Manual, or go to: <http://www.clearcom.com/product/digital-matrix/interface-modules/cci-22>

#### Powering the connection:

You must power the connection between the HMS-4X Main Station and the CCI-22 using either a dedicated power supply (such as the PK-7, PS-702, or PS-704), or a powered Encore Main Station (such as the MS-702 or MS-704).

**Tip:** For more information about the PK-7 or PS-70x power supply devices from Clear-Com, see <http://www.clearcom.com/product/partyline/power-supplies>

#### Connecting the systems:

There are two parallel DB-9M Interface I/O connectors on the CCI-22. The two-wire module on the HMS-4X Main Station features two 3-pin XLR connectors. For more information about wiring the connection, see:

- 13.6.2 Quick reference: Two-wire connection to Eclipse.
- The CCI-22 Manual.

- 3) Apply nulling to the connected channel on the CCI-22. To null the channel:
  - a) Insert the accessory earphone into the front-panel **Test** jack. A test tone, for all frequencies, is produced every 0.5s.
  - b) While listening to the test tone, adjust the **R** (Resistance) control until the tone is at a minimum.
  - c) Repeat Step b. for the **L** (Inductance) and **C** (Capacitance) controls. These controls compensate for each component of the line's impedance, providing the best possible null.

Because the **R**, **L** and **C** controls interact, you may have to adjust these controls several times to minimize the test tone / achieve a deep null.

**Note:** The null circuit on the CCI-22 is effective on line lengths between 0 - 4000 feet (1200m) with impedances in the range of 120 to 350 ohms. Nulling can reduce local audio in the received signal by < 30 dB over the 200 Hz - 8 kHz frequency range.

**Tip:** For more information on the CCI-22 nulling circuit, see the **CCI-22 Manual**.

- 4) If necessary, adjust the **In / Out** level controls on the CCI-22 (**Send** and **Recv**, located on the front panel next to the **R**, **L** and **C** nulling controls).

**Note:** The **Send** level control affects the level of the audio signals from the Eclipse Matrix to the external party-line, and the **Recv** control affects the level of the audio from the party-line into the matrix. The Send and Receive controls have a range of  $\pm 13$  dB.

**Tip:** For more information about managing the HelixNet to Eclipse connection in EHX, see your EHX documentation (including **Help**).

### 13.6.4 Quick reference: Four-wire connection to Eclipse

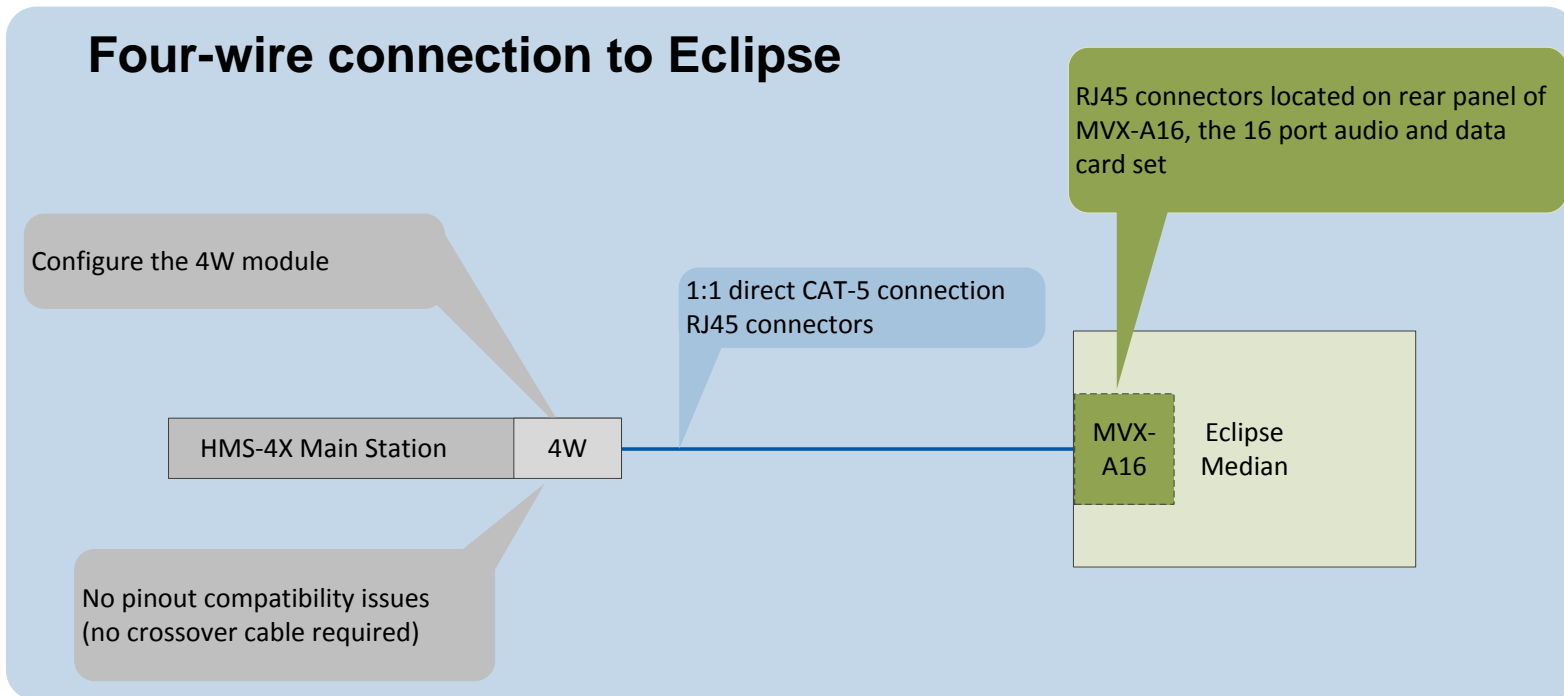

Figure 13-10: Four-wire connection to Eclipse Matrix



## 13.6.5 Four-wire connection to Eclipse

To connect your HelixNet Partyline system to an Eclipse or Eclipse-HX System, using a four-wire connection:

- 1) On the HMS-4X Main Station, configure the **Module Settings** for the four-wire interface module. For the procedure, see **4.6.1 Configuring a Four-wire interface module**.
- 2) Connect the HMS-4X Main Station directly to the MVX-A16 card (the 16 port audio and data card set) with **standard** CAT5 cable.

**Note:** For pinout information for the two systems, see the **quick reference diagram** in **13.6.4 Quick reference: Four-wire connection to Eclipse**.

RJ45 connectors are located:

- On the HMS-4X Main Station four-wire interface module.
- On the rear panel of the MVX-A16 card.

**Tip:** To optimize audio quality, you may want to adjust the **Audio Settings** on the HMS-4X Main Station. For more information, see **4.2 Configuring the Audio settings**

**Tip:** For more information about managing the HelixNet to Eclipse connection in ECS, see your ECS documentation (including ECS Help).

## 13.7 Connecting HelixNet Partyline to two-way radio systems

Two-way radio systems (also known as walkie-talkies) are widely used for wireless communication where quick deployment is a required.

HelixNet can interface to a two-way radio system audio along with transmit key control.

The following examples show how you can setup HelixNet to activate a relay on a Main Station or a Remote Station every time someone activates a Talk key on the selected Partyline Channel.

**Note:** HelixNet provides and expects 4W audio at line level (0dBu).

### 13.7.1 Quick Reference: four-wire and control connection to radio system

#### Four-wire connection to radio system

Configure the 4W module



Pin	Function
1	Data out +
2	Data out -
3	Audio out +
4	Audio in +
5	Audio in -
6	Audio out -
7	Data in +
8	Data in -

Pin	Function	Pin	Function
1	Relay 1 NC	14	Relay 1 Pole
2	Relay 1 NO	15	Relay 2 NC
3	Relay 2 Pole	16	Relay 2 NO
4	Relay 3 NC	17	Relay 3 Pole
5	Relay 3 NO	18	Relay 4 NC
6	Relay 4 Pole	19	Relay 4 NO
7		20	+5V
8	GND	21	+5V
9	GND	22	Opto 1-
10	Opto 1+	23	Opto 2-
11	Opto 2+	24	Opto 3-
12	Opto 3+	25	Opto 4-
13	Opto 4+		

Figure 13-11 Four-wire and control connection to radio system

## 13.7.2 Four-wire and control connection to radio system

To connect the HelixNet Partyline to a radio system using four-wire:

- 1) In the **Modules Settings** menu, select **Slot n/Port A/B 4W > Channel Assign > Channel #** to assign the 4W port to a **Channel**, for example Channel A.
- 2) In the **Modules Settings** menu, select **Slot n/Port A/B 4W > GPO Trigger > Disable** to set **GPO Trigger** to **Disable** for that 4W port.
- 3) In the **Channels** menu, select **Channel # > GPO on Talk > Relay #** to select a Relay.
- 4) Connect the 4W audio and the configured Relay to the radio base station.

### 13.7.3 Quick reference: two-wire and control connection to radio system

## Two-wire connection to radio system

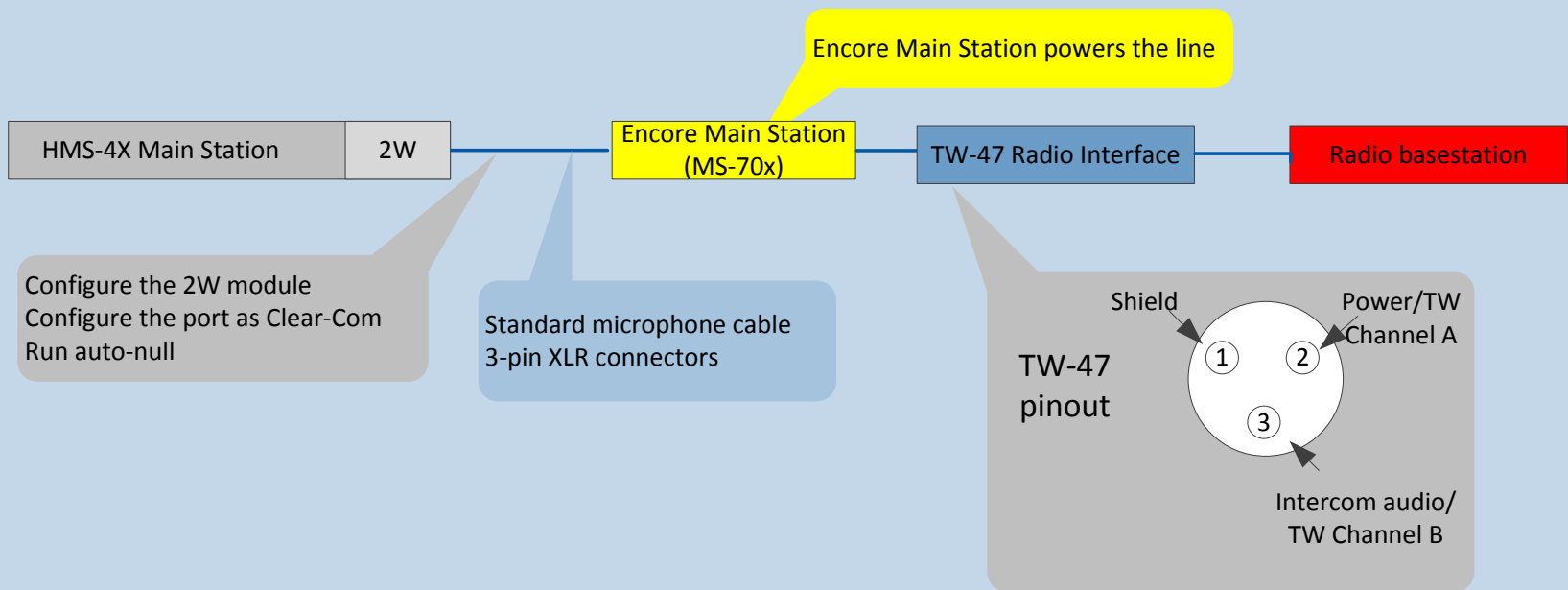

Figure 13-12 Two-wire and control connection to radio system

## 13.7.4 Two-wire and control connection to radio system

The two-wire connection uses a TW-47 radio interface. Because this has no power supply, you must use an Encore Main Station to supply power. You can also use an alternative source of power, such as a PK-7, PS-702 or PS-704.

The diagram in Figure 13-12 shows a system using an Encore Main Station.

To connect the HelixNet Partyline to a radio system using two-wire:

- 1) Connect the HelixNet Partyline to the Encore Main Station. For details, see **13.1 Connecting HelixNet Partyline to Encore®**.
- 2) In the **Modules Settings** menu, select **Slot n/Port A/B 2W > Channel Assign > Channel #** to assign the 2W port to a **Channel**, for example Channel A.
- 3) Connect the Encore Main Station to the TW-47 radio interface.
- 4) Connect the TW-47 radio interface to the radio basestation.

### 13.7.5 Quick reference: Main Station connection to radio system

#### Four-wire connection to radio system

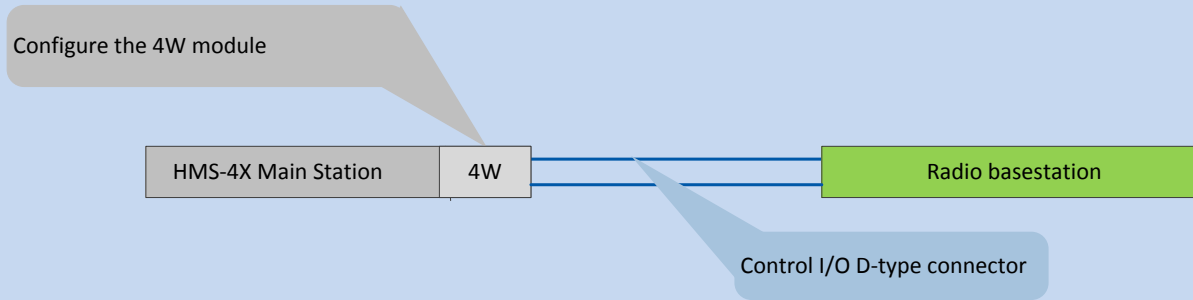

Pin	Function	Pin	Function
1	Relay 1 NC	14	Relay 1 Pole
2	Relay 1 NO	15	Relay 2 NC
3	Relay 2 Pole	16	Relay 2 NO
4	Relay 3 NC	17	Relay 3 Pole
5	Relay 3 NO	18	Relay 4 NC
6	Relay 4 Pole	19	Relay 4 NO
7		20	+5V
8	GND	21	+5V
9	GND	22	Opto 1-
10	Opto 1+	23	Opto 2-
11	Opto 2+	24	Opto 3-
12	Opto 3+	25	Opto 4-
13	Opto 4+		

Figure 13-13 Main Station connection to radio system

To connect the HelixNet Main Station to a radio system using four-wire:

- 1) In the **Audio Settings** menu, select **PGM/Audio In > GPO Trigger > Disable**.
- 2) In the **Audio Settings** menu, select **SA/Audio Out Mode > Channel Assign**.
- 3) Assign the SA/Audio Out to a Channel.
- 4) In the **Channel** configuration select the Remote Station Program under the Program Listen menu.
- 5) In the **Channels** menu, select **Channel # > GPO on Talk > Relay 1**.
- 6) Connect the audio and the Relay to the radio base station.

## 14 Specifications

### 14.1 Main Station (HMS-4X)

#### 14.1.1 Connectors

Specification	Description / value
Intercom Powerline Outputs	Four 3-pin XLR. Two male and two female.
Headset	4-pin XLR-M
USB	USB Type A and Micro-AB
Program	3-pin XLR-F
SA (Stage Announce)	3-pin XLR-M
Hot Mic / IFB Interface	1/4 in. (0.64 cm) phone jack
GPIO	25 way D-type female

Table 14-1: Main Station: Connectors

#### 14.1.2 Microphone pre-amplifier

Specification	Description / value
Headset Mic impedance:	200Ω (Dynamic)
Headset Mic Voltage	1.7V (Electret selectable)
Limiter	+23dB
The following specified for a route to 4-wire output @ 0dBu out	
Mic gain	60dB (dynamic) 45dB (electret)
Frequency response	300Hz – 10kHz ± -3dB (contoured for intelligibility)
Distortion	<0.2% THD @ 1kHz
Noise-	<-55dBu dynamic, <-65dBu electret

Table 14-2: Main Station: Microphone pre-amplifier

#### 14.1.3 Headphone amplifier

Specification	Description / value
---------------	---------------------



<b>Load impedance</b>	32Ω
<b>Output level</b>	+12dBu before clipping
<b>Sidetone</b>	-12dB (selectable)
<b>The following specified for a route from a 4-wire input @ 0dBu in</b>	
<b>Max gain</b>	0dB
<b>Frequency response</b>	40Hz - 10kHz ± 3dB
<b>Distortion</b>	<0.1% THD @ 1kHz
<b>Noise</b>	<-65dBu
<b>Headphone limiter</b>	0dBu (selectable)

**Table 14-3: Main Station: Headphone amplifier**

#### 14.1.4 Loudspeaker amplifier

<b>Specification</b>	<b>Description / value</b>
<b>Load impedance</b>	8Ω
<b>Output level</b>	+18dBu before clipping
<b>Max gain</b>	18dB
<b>The following specified for a route from a 4-wire input @ 0dBu in</b>	
<b>Frequency response</b>	200Hz - 10kHz ± 3dB
<b>Distortion</b>	<1% THD @ 1 kHz
<b>Noise</b>	<-50dBu

**Table 14-4: Main Station: Loudspeaker amplifier**

### 14.1.5 Program line input and Four-wire option module inputs

Specification	Description / value
Maximum level before clipping	18dBu
Nominal input level	0dBu (selectable)
Input impedance	$\geq 10\text{K}\Omega$
The following specified for a route to 4-wire output @ 0dBu out	
Frequency response	20Hz - 10kHz $\pm$ 3dB
Distortion	<0.2% THD @ 1kHz
Noise	<-65dBu

Table 14-5: Main Station: Program line input and four-wire option module inputs

### 14.1.6 Four-wire module outputs

Specification	Description / value
Maximum level before clipping	18dBu
Nominal input level	0dBu (selectable)
Input impedance	$\leq 100\Omega$

Table 14-6: Main Station: Four-wire module outputs

## 14.1.7 Stage Announce outputs

Specification	Description / value
Maximum level before clipping	18dBu
Nominal output level	0dBu (selectable)
Output impedance	$\leq 100\Omega$
The following specified for a route from a dynamic headset	
Frequency response	300Hz – 12kHz $\pm$ 3dB
Distortion	<0.1% THD @ 1kHz
Noise	<-55dBu

Table 14-7: Main Station: Stage Announce outputs

## 14.1.8 Hot Mic output

Specification	Description / value
Maximum level before clipping	12dBu
Nominal output level	0dBu (selectable)
Output impedance	$\leq 100\Omega$
The following specified for a route from a dynamic headset	
Frequency response	300Hz - 12kHz $\pm$ 2dB
Distortion	<0.2% THD @ 1kHz
Noise	<-55dBu

Table 14-8: Main Station: Hot Mic output

## 14.1.9 Helix Digital Partyline

Specification	Description / value
Maximum level before clipping	6dBu
Nominal input level	-18dBu (C-C) -12dBu (RTS)
Input impedance	>= 10KΩ bridging
The following specified for a circuit to a 4-wire output @0dBu in:	
Frequency response	100Hz - 10 kHz ± 3dB
Distortion	<0.2% THD @ 1kHz
Noise	<-55dBu
The following specified for a circuit from a 2-wire input @0dBu out:	
Frequency response	40Hz - 10kHz ± 3dB
Distortion	<0.2% THD @ 1kHz
Noise	<-55dBu
Auto-nulling and echo cancellation	Yes
RTS / Clear-Com selectable	Yes
Termination	External
Power	30V external

Table 14-9: Main Station: Partyline

## 14.1.10 Ethernet

Specification	Description / value
Fast Ethernet standard	100BaseT only, Auto MDIX

Table 14-10: Main Station: Ethernet

### 14.1.11 Mains power

Specification	Description / value
Input Voltage range	100 – 240VAC
Input frequency range	50 – 60Hz
Input power	<=250W
Powerline Intercom Output Voltage	59VDC ± 1V
Output current per channel	1.5A (continuous)

Table 14-11: Main Station: Mains power

### 14.1.12 Environmental

Specification	Description / value
Temperature	0°C - 40°C (32°F - 104°F)
Humidity	0 - 90% relative humidity

Table 14-12: Main Station: Environmental

### 14.1.13 Dimensions and weight

Specification	Description / value
Dimensions	19in.W x 1.75in.H x ? in. D (483 mm x 44 mm x ? mm)
Weight	5.83lbs. (2.65kg)

Table 14-13: Main Station: Dimensions and weight

## 14.2 Two-wire module (HLI-2W2)

### 14.2.1 Connectors

Specification	Description / value
Intercom line	(2) 3-Pin XLR-F

Table 14-14: two-wire module: Connectors

### 14.2.2 Dimensions and weight

Specification	Description / value
Dimensions	7.05 in. H x 2.24 in. W x 1.54 in. D (179 x 57 x39 mm)
Weight	13 oz. (0.35 kg)

Table 14-15: Two-wire module: Dimensions and weight

### 14.2.3 Power requirements (external)

Specification	Description / value
Per channel	0.025mA/channel
DC Voltage range	20 – 30 Volts

Table 14-16: Two-wire module: Power requirements

### 14.2.4 Environmental

Specification	Description / value
Temperature	0°C - 40°C (32°F - 104°F)
Humidity	0 - 90% relative humidity

Table 14-17: Two-wire module: Environmental

## 14.3 Four-wire module (HLI-4W2)

### 14.3.1 Connectors

Specification	Description / value
Intercom line	(2) RJ-45 (Ethercon)

Table 14-18: Four-wire module: Connectors

### 14.3.2 Dimensions and weight

Specification	Description / value
Dimensions	7.05 in. H x 2.24 in. W x 1.54 in. D (179 x 57 x39 mm)
Weight	13 oz. (0.35 kg)

Table 14-19: four-wire module: Dimensions and weight

### 14.3.3 Environmental

Specification	Description / value
Temperature	0°C - 40°C (32°F - 104°F)
Humidity	0 - 90% relative humidity

Table 14-20: four-wire module: Environmental

## 14.4 Remote Station (HRM-4X)

### 14.4.1 Connectors

Specification	Description / value
Intercom Powerline Outputs	Four 3-pin XLR. Two male and two female.
Headset	4-pin XLR-M
USB	USB Type A
Program	3-pin XLR-F
SA (Stage Announce)	3-pin XLR-M
Hot Mic / IFB Interface	1/4 in. (0.64 cm) phone jack
Control input/output	9-pin D-type

Table 14-21: Remote Station: Connectors

### 14.4.2 Microphone pre-amplifier

Specification	Description / value
Headset Mic impedance:	200 Ω (Dynamic)
Headset Mic Voltage	1.7V (Electret selectable)
Limiter	+23 dB
The following specified for a route to 4-wire output @ 0dBu out	
Mic gain	60dB (dynamic) 45dB (electret)
Frequency response	300 Hz – 10 kHz + / -3dB (contoured for intelligibility)
Distortion	<0.2% THD @ 1 kHz
Noise-	<-55dBu dynamic, <-65dBu electret

Table 14-22: Remote Station: Microphone pre-amplifier

### 14.4.3 Headphone amplifier

Specification	Description / value
Load impedance	32 Ω
Output level	+12dBu before clipping
Sidetone	-12dB (selectable)
The following specified for a route from a 4-wire input @ 0dBu in	
Max gain	0dB
Frequency response	40 Hz - 10 kHz ±3dB
Distortion	<0.1% THD @ 1 kHz
Noise	<-65dBu
Headphone limiter	0dBu (selectable)

Table 14-23: Remote Station: Headphone amplifier

### 14.4.4 Loudspeaker amplifier

Specification	Description / value
---------------	---------------------



<b>Load impedance</b>	8 $\Omega$
<b>Output level</b>	+18dBu before clipping
<b>Max gain</b>	18dB
The following specified for a route from a 4-wire input @ 0dBu in	
<b>Frequency response</b>	200 Hz - 10 kHz $\pm$ 3dB
<b>Distortion</b>	<1% THD @ 1 kHz
<b>Noise</b>	<-50dBu

Table 14-24: Remote Station: Loudspeaker amplifier

#### 14.4.5 Program line input and four-wire option module inputs

Specification	Description / value
<b>Maximum level before clipping</b>	18 dBu
<b>Nominal input level</b>	0dBu(selectable)
<b>Input impedance</b>	$\geq$ 10 K $\Omega$
The following specified for a route to 4-wire output @ 0dBu out	
<b>Frequency response</b>	20 Hz - 10 kHz $\pm$ 3dB
<b>Distortion</b>	<0.2% THD @ 1 kHz
<b>Noise</b>	<-65dBu

Table 14-25: Remote Station: Program line input and four-wire option module inputs

#### 14.4.6 Four-wire module outputs

Specification	Description / value
<b>Maximum level before clipping</b>	18 dBu
<b>Nominal input level</b>	0 dBu(selectable)
<b>Input impedance</b>	$\leq$ 100 $\Omega$

Table 14-26: Remote Station: Four-wire module outputs

### 14.4.7 Stage Announce outputs

Specification	Description / value
Maximum level before clipping	18 dBu
Nominal output level	0dBu(selectable)
Output impedance	<= 100Ω
The following specified for a route from a dynamic headset	
Frequency response	300Hz – 12kHz ±3dB
Distortion	<0.1% THD @ 1kHz
Noise	<-55dBu

Table 14-27: Remote Station: Stage Announce outputs

### 14.4.8 Hot Mic output

Specification	Description / value
Maximum level before clipping	12 dBu
Nominal output level	0dBu(selectable)
Output impedance	<= 100Ω
The following specified for a route from a dynamic headset	
Frequency response	300 Hz - 12 kHz ±2dB
Distortion	<0.2% THD @ 1 kHz
Noise	<-55dBu

Table 14-28: Remote Station: Hot Mic output

## 14.4.9 Helix Digital Partyline

Specification	Description / value
Maximum level before clipping	6 dBu
Nominal input level	-18dBu (C-C) -12dBu (RTS)
Input impedance	>= 10KΩ bridging
The following specified for a circuit to a 4-wire output @0dBu in:	
Frequency response	100Hz - 10 kHz ±3dB
Distortion	<0.2% THD @ 1 kHz
Noise	<-55dBu
The following specified for a circuit from a 2-wire input @0dBu out:	
Frequency response	40 Hz - 10 kHz ±3dB
Distortion	<0.2% THD @ 1 kHz
Noise	<-55dBu
Auto-nulling and echo cancellation	Yes
RTS / Clear-Com selectable	Yes
Termination	External
Power	30V external

Table 14-29: Remote Station: Partyline

## 14.4.10 Ethernet

Specification	Description / value
Fast Ethernet standard	100BaseT only, Auto MDIX

Table 14-30: Remote Station: Ethernet

### 14.4.11 Mains power

Specification	Description / value
Input Voltage range	100 – 240 VAC
Input frequency range	50 – 60 Hz
Input power	<=250W
Powerline Intercom Output Voltage	59VDC ± 1V
Output current per channel	1.5A (continuous)

Table 14-31: Remote Station: Mains power

### 14.4.12 Environmental

Specification	Description / value
Temperature	0°C - 40°C (32°F - 104°F)
Humidity	0 - 90% relative humidity

Table 14-32: Remote Station: Environmental

### 14.4.13 Dimensions and weight

Specification	Description / value
Dimensions	19 in. W x 1.75 in. H x ? in. D (483 mm x 44 mm x ? mm)
Weight	5.83 lbs. (2.65 kg)

Table 14-33: Remote Station: Dimensions and weight

## 14.5 Speaker Station (HKB-4X)

### 14.5.1 Connectors

Specification	Description / value
Intercom line	Two 3-pin XLR. One male and one female.
Headset	4-pin XLR-M

Table 14-34: Speaker Station: Connectors

### 14.5.2 Microphone pre-amplifier

Specification	Description / value
Headset Mic impedance:	200 $\Omega$ (Dynamic)
Headset Mic Voltage	1.7V (Electret selectable)
Limiter	+23 dB
The following specified for a route to 4-wire output @ 0dBu out:	
Mic gain	60dB (dynamic) 45dB (electret)
Frequency response	300 Hz – 10 kHz + / -3dB (contoured for intelligibility)
Distortion	<0.2% THD @ 1 kHz
Noise-	<-55dBu dynamic, <-65dBu electret

Table 14-35: Speaker Station: Microphone pre-amplifier

### 14.5.3 Headphone amplifier

Specification	Description / value
Load impedance	>32 $\Omega$
Output level	+12dBu before clipping
Sidetone	-12dB (selectable)
The following specified for a route from a 4-wire input @0dBu in:	
Max gain	0dB
Frequency response	40 Hz - 10 kHz $\pm$ 3dB
Distortion	<0.1% THD @ 1 kHz
Noise	<-65dBu (@ max gain)
Headphone limiter	-0dBu (selectable)

Table 14-36: Speaker Station: Headphone amplifier

## 14.5.4 Ethernet

Specification	Description / value
Fast Ethernet standard	100BaseT only, Auto MDIX

Table 14-37: Speaker Station: Ethernet

## 14.5.5 Power requirements

Specification	Description / value
Power requirements	4W
DC Voltage range	30 – 60 Volts

Table 14-38: Speaker Station: Power requirements

## 14.5.6 Environmental

Specification	Description / value
Temperature	0°C - 40°C (32°F - 104°F)
Humidity	0 - 90% relative humidity

Table 14-39: Speaker Station: Environmental

## 14.6 Beltpack (HBP-2X)

### 14.6.1 Connectors

Specification	Description / value
Intercom line	Two 3-pin XLR. One male and one female.
Headset	4-pin XLR-M and 2.5mm TRS jack
USB	Micro-AB
TRS Headset	3.5mm mini jack

Table 14-40: Beltpack: Connectors

### 14.6.2 Microphone pre-amplifier

Specification	Description / value
Headset Mic impedance:	200 $\Omega$ (Dynamic)
Headset Mic Voltage	1.7V (Electret selectable)
Limiter	+23 dB
The following specified for a route to 4-wire output @ 0dBu out:	
Mic gain	60dB (dynamic) 45dB (electret)
Frequency response	300 Hz – 10 kHz + / -3dB (contoured for intelligibility)
Distortion	<0.2% THD @ 1 kHz
Noise-	<-55dBu dynamic, <-65dBu electret

Table 14-41: Beltpack: Microphone pre-amplifier

### 14.6.3 Headphone amplifier

Specification	Description / value
Load impedance	>32 $\Omega$
Output level	+12dBu before clipping
Sidetone	-12dB (selectable)
The following specified for a route from a 4-wire input @0dBu in:	
Max gain	0dB
Frequency response	40 Hz - 10 kHz $\pm$ 3dB
Distortion	<0.1% THD @ 1 kHz
Noise	<-65dBu (@ max gain)
Headphone limiter	-0dBu (selectable)

Table 14-42: Beltpack: Headphone amplifier

### 14.6.4 Power requirements

Specification	Description / value
Power requirements	4W
DC Voltage range	30 – 60 Volts

Table 14-43: Beltpack: Power requirements

### 14.6.5 Environmental

Specification	Description / value
Temperature	0°C - 40°C (32°F - 104°F)
Humidity	0 - 90% relative humidity

Table 14-44: Beltpack: Environmental



## 15 Compliance

---

### FCC notice

This device complies with Part 15 of the FCC rules. Operation is subject to the following two conditions: (1) This device may not cause harmful interference, and (2) This device must accept any interference received, including interference that may cause undesired operation.

**NOTE:** This equipment has been tested and found to comply with the limits for a Class A digital device, pursuant to Part 15 of the FCC rules. These limits are designed to provide reasonable protection against harmful interference when the equipment is operated in a commercial environment. This equipment generates, uses and can radiate radio frequency energy and, if not installed and used in accordance with the instruction manual, may cause harmful interference to radio communication. Operation of this equipment in a residential area is likely to cause harmful interference, in which case the user will be required to correct the interference at his own expense.

Changes or modifications not expressly approved by Clear-Com, LLC, an HM Electronics, Inc. company could void the user's authority to operate this equipment.

### Industry Canada Compliance Statement

This Class[A] digital device complies with Canadian ICES-003.

### Avis de conformité à la réglementation d'Industrie Canada

Cet appareil numérique de la class[\*] est conforme à la norme NMB-003 du Canada.

### Korean notice

A급 기기 (업무용 방송통신기자재)

이 기기는 업무용(A급)으로 전자파적합기기로서 판매자 또는 사용자는 이 점을 주의하시기 바라며, 가정외의 지역에서 사용하는 것을 목적으로 합니다.

**The HMS-4X, HRM-4X, HBP-2X, HBP-2XS, HLI-2W2 and HLI-4W2 products comply with the following specifications:**

EN55022 Emissions

EN55024 Immunity

Electromagnetic Compatibility Directive 2004/108/EC

Low Voltage Directive 2006/95/EC

### **Warning:**

*This is a Class A product. In a domestic environment this product may cause radio interference in which case the user may be required to take adequate measures.*

**The HMS-4X, HLI-2W2 and HLI-4W2 products comply with the following specifications:**

UL 60065-7

CAN/CSA-C22.2 No.60065-3

### **Waste Electrical And Electronic Equipment (WEEE)**

The European Union (EU) WEEE Directive (2002/96/EC) places an obligation on producers (manufacturers, distributors and/or retailers) to take-back electronic products at the end of their useful life. The WEEE Directive covers most Clear-Com products being sold into the EU as of August 13, 2005. Manufacturers, distributors and retailers are obliged to finance the costs of recovery from municipal collection points, reuse, and recycling of specified percentages per the WEEE requirements.

### **Instructions for Disposal of WEEE by Users in the European Union**

The symbol shown below is on the product or on its packaging which indicates that this product was put on the market after August 13, 2005 and must not be disposed of with other waste. Instead, it is the user's responsibility to dispose of the user's waste equipment by handing it over to a designated collection point for the recycling of WEEE. The separate collection and recycling of waste equipment at the time of disposal will help to conserve natural resources and ensure that it is recycled in a manner that protects human health and the environment. For more information about where you can drop off your waste equipment for recycling, please contact your local authority, your household waste disposal service or the seller from whom you purchased the product.



**Figure 15-1: WEEE Symbol**

## 16 Menu maps

### HMS-4X Main Station menu map

Menu 1 (First) >	Menu 2 >	Menu 3>	Menu 4 (Last )
Audio Settings	Headset	Sidetone Gain	<b>Range:</b> 0dB to -18dB <b>Default:</b> -12db
		Headphone Limit	<b>Range:</b> +6dB to -6dB <b>Default:</b> 0db
		Sidetone Control	Tracking Non-Tracking Disabled <b>Default:</b> Tracking
		HS Mic Type	Electret Dynamic (0 dB) Dynamic (-10 dB) <b>Default:</b> Dynamic (0 dB)
	Microphone	Headroom	Normal High <b>Default:</b> Normal
		Contour Filter	Enabled Disabled <b>Default:</b> Enabled
	Program Input	Gain	<b>Range:</b> +12dB to -12dB <b>Default:</b> 0db
		GPO Trigger	Enabled Disabled <b>Default:</b> Enabled
		VOX	Enabled Disabled <b>Default:</b> Disabled

Menu 1 (First) >	Menu 2 >	Menu 3>	Menu 4 (Last )
		VOX Off Delay	<b>Range:</b> 0.5 – 4 sec <b>Default:</b> 0.5 sec
	Program IFB	IFB Dim Level	IFB Disabled + <b>Range:</b> -6dB - -24dB + Full Cut
	SA Output	Gain	<b>Range:</b> +12dB to -12dB <b>Default:</b> 0db
	Hot Mic Output		
	Front Panel	Loudspeaker Dim	<b>Range:</b> 0dB to -24dB <b>Default:</b> -6dB
Station Settings	Preferences	Station ID	Alphanumeric entry
	Keypad Assign	Keypad 1 – 4	None [conf_name_1], [conf_name_2], [conf_name_3], [conf_name_4] <b>Default:</b> [conf_name_1]
	Keysets	Talk #1 Latch	Latching Non-Latching <b>Default:</b> Latching
		Talk #2 Latch	
		Talk #3 Latch	
		Talk #4 Latch	
		SA Output Key	Latching Non-Latching <b>Default:</b> Non-latching
		RMK	Enabled Disabled <b>Default:</b> Enabled
	Display	OLED Brightness	High Medium

Menu 1 (First) >	Menu 2 >	Menu 3>	Menu 4 (Last )
			Low <b>Default:</b> Medium
		<b>Key Brightness</b>	High / Low High / Off Low / Off Off / Off <b>Default:</b> High / Low
		<b>Screensaver</b>	Enabled Disabled <b>Default:</b> Enabled
<b>Channels</b>	<b>Channel A</b> <b>Channel B</b> <b>Channel C</b> <b>Channel D</b> [...]	<b>Label</b>	Press to Edit <b>Max. length for labels</b> = 10 characters
		<b>Program Listen</b>	None List of programs <b>Default:</b> None
		<b>GPO on Talk</b>	<b>Default:</b> None Relay 1 - 4
		<b>GPO on Call</b>	<b>Default:</b> None Relay 1 - 4
<b>Control I/O</b>	<b>Inputs</b>	<b>Opto 1</b>	None Call Key 1 Talk Key 1 Call Key 2 Talk Key 2 Call Key 3 Talk Key 3 Call Key 4 Talk Key 4 <b>Default:</b> None
		<b>Opto 2</b>	
		<b>Opto 3</b>	
		<b>Opto 4</b>	
	<b>Outputs</b>	<b>Relay 1</b>	
		<b>Relay 2</b>	
		<b>Relay 3</b>	
		<b>Relay 4</b>	

Menu 1 (First) >	Menu 2 >	Menu 3>	Menu 4 (Last )
Module Settings	Slot <i>n</i> /Port A/B 4W	Channel Assign	Disabled Channel A Channel B Channel C Channel D <b>Default:</b> Disabled
		Program Output	Unmute Mute <b>Default:</b> Mute
		GPO Trigger	Enabled Disabled <b>Default:</b> Enabled
		Input Gain	<b>Range:</b> +12dB to -12dB <b>Default:</b> 0db
		Output Gain	
		VOX	Enabled Disabled <b>Default:</b> Disabled
		VOX Off Delay	<b>Range:</b> [0].5 – 4 secs <b>Default:</b> [0].5 secs
	Slot <i>n</i> /Port A/B 2W	Channel Assign	Disabled Channel A Channel B Channel C Channel D <b>Default:</b> Disabled

Menu 1 (First) >	Menu 2 >	Menu 3>	Menu 4 (Last )
		Program Output	Unmute Mute <b>Default:</b> Unmute
		Auto-Nulling	Start
		Mode	Clear-Com RTS Audio Pin 2 RTS Audio Pin 3 <b>Default:</b> Clear-Com
		GPO Trigger	Enabled Disabled <b>Default:</b> Enabled
		Input Gain	<b>Range:</b> -3dB to +3dB <b>Default:</b> 0db
		Output Gain	
		RMK Input	Enabled Disabled <b>Default:</b> Enabled
		RMK Output	
		VOX	Enabled Disabled <b>Default:</b> Disabled
		VOX Off Delay	<b>Range:</b> [0].5 – 4 secs <b>Default:</b> [0].5 secs
Network	Stations	[Station IDs]	Separate Linked <b>IP address:</b> xx.xx.xx.xx where x is a numeric value
	Linking	Link Station	Disabled Enabled <b>Default:</b> Disabled
	Preferences	DHCP	Enabled Disabled <b>Default:</b> Enabled
		IP Address	<b>IP address:</b> xx.xx.xx.xx where x is a numeric value
		Gateway	<b>IP address:</b> xx.xx.xx.xx where x is a numeric value

Menu 1 (First) >	Menu 2 >	Menu 3>	Menu 4 (Last )
		<b>Subnet Mask</b>	<b>IP address: xx.xx.xx.xx</b> where x is a numeric value
<b>Administration</b>	<b>Software</b>	<b>Current</b>	MS Version IVR Version Snx Version where n is slot number and x is the port
		<b>Update</b>	None or version list
	<b>Beltpacks</b>	<b>Menu Lock</b>	Unlock All Lock All
	<b>Reset</b>	<b>Reset to Default</b>	Reset HMS Reset Devices Reset All
		<b>Reboot</b>	Reboot Now
	<b>Settings</b>	<b>Save</b>	USB drive or local
		<b>Restore</b>	USB drive or file list
<b>Diagnostics</b>	<b>Hardware</b>	<b>Main PCB</b>	Part: [Part_Number] Revision: [Revision] Serial number: [Serial number]
		<b>Slot 1 PCB</b>	
		<b>Slot 2 PCB</b>	
		<b>Slot 3 PCB</b>	
	<b>Temperature</b>	<b>Sensor 1</b>	Temperature in °C.  <b>Note:</b> <i>Single fan on if any sensor &gt; 60°C. Double fan on if any sensor &gt; 65°C. Double fan off if &lt; 55°C / single fan off if &lt; 50°C.</i>
		<b>Sensor 2</b>	
		<b>Sensor 3</b>	
	<b>Powerlines</b>	<b>Powerline 1</b>	Status: [OK or BUSY (according to responses to MME requests)]. DMC:[MAC of powerline modem] HMC: [MAC of local blackfin processor] Beltpacks: [# of beltpacks detected by powerline modem] Collision rate: [Percentage (0% when operating normally)] Error rate: [Percentage (0% when operating normally)] Volts: [Voltage]
		<b>Powerline 2</b>	



Menu 1 (First) >	Menu 2 >	Menu 3>	Menu 4 (Last )
	<b>Keysets</b>	<b>Keyset 1</b> <b>Keyset 2</b> <b>Keyset 3</b> <b>Keyset 4</b>	Name: Channel name Talkers: Number of talkers on party line Devices: Number of beltpacks listening on party line Main Stations: Number of Main Stations listening 2-Wire: Number of 2-Wire ports listening 4-Wire: Number of 4-Wire ports listening

## HRS-4X Remote Station menu map

Menu 1 (First) >	Menu 2 >	Menu 3>	Menu 4 (Last)
Audio Settings	Headset	Sidetone Gain	Range: 0dB to -18dB Default: -12db
		Headphone Limit	Off + Range: +6dB to -6dB Default: 0db
		Sidetone Control	Tracking Non-Tracking Disabled Default: Tracking
		HS Mic Type	Electret Dynamic (0 dB) Dynamic (-10 dB) Default: Dynamic (0 dB)
	Microphone	Headroom	Normal High Default: Normal
		Contour Filter	Enabled Disabled Default: Enabled
	Program Input	Gain	Range: +12dB to -12dB Default: 0db
		IFB Dim Level	Range: --6dB to -24dB Default: Off
		GPO Trigger	Enabled Disabled Default: Enabled
		VOX	Enabled Disabled Default: Disabled

Menu 1 (First) >	Menu 2 >	Menu 3>	Menu 4 (Last )
		VOX Off Delay	Range: 0.5 - 4sec Default: 0.5sec
	SA Output	Mode	Channel Assigned SA Default: Channel Assigned
		Gain	Range: +12 to -12dB Default: 0dB
		Program Output	Unmute Mute Default: Mute
		Channel Assign	Disabled Channel A Channel B Channel C Channel D Default: Disabled
	Hot Mic Output	Gain	Range: +12 to -12dB Default: 0dB
	Front Panel	Loudspeaker Dim	Range: 0dB to -24dB Default: -6dB

Menu 1 (First) >	Menu 2 >	Menu 3>	Menu 4 (Last)
Station Settings	Preferences	Program ID	Alphanumeric entry Default: HRM – [unique ID]
	Keypad Assign	Keypad 1 – 4	None [conf_name_1], [conf_name_2], [conf_name_3], [conf_name_4] Default: [conf_name_1]
	Keypads	Talk #1 Latch	Latching Non-Latching Default: Latching
		Talk #2 Latch	
		Talk #3 Latch	
		Talk #4 Latch	
		SA Output Key	Latching Non-Latching Default: Non-latching
		RMK	Enabled Disabled Default: Enabled
	Display	OLED Brightness	High Medium Low Default: Medium
		Key Brightness	High / Low High / Off Low / Off Off / Off Default: High / Low
		Screensaver	Enabled Disabled Default: Enabled

Menu 1 (First) >	Menu 2 >	Menu 3>	Menu 4 (Last )
<b>Channels</b>	<b>Channel A</b> <b>Channel B</b> <b>Channel C</b> <b>Channel D</b> <b>[...]</b>	<b>Label</b>	Press to Edit <b>Max. length for labels = 10 characters</b>
		<b>Program Listen</b>	None List of programs <b>Default: None</b>
		<b>GPO on Talk</b>	<b>Default: None</b> Relay 1 - 4
		<b>GPO on Call</b>	<b>Default: None</b> Relay 1 - 4

Menu 1 (First) >	Menu 2 >	Menu 3>	Menu 4 (Last)
Control I/O	Inputs	Opto 1	None Call Key 1 Talk Key 1 Call Key 2 Talk Key 2 Call Key 3 Talk Key 3 Call Key 4 Talk Key 4 Default: None
	Outputs	Relay 1	
Network	Pair to Station	By Name By Address	Separate IP address: xx.xx.xx.xx where x is a numeric value
	Preferences	DHCP	Enabled Disabled Default: Enabled
		IP Address	IP address: xx.xx.xx.xx where x is a numeric value
		Gateway	IP address: xx.xx.xx.xx where x is a numeric value
		Subnet Mask	IP address: xx.xx.xx.xx where x is a numeric value
Administration	Software	Current	HelixNet System Version Remote Station Version
		Update	None or version list
	Reset	Reset to Default	Reset Now
		Reboot	Reboot Now
	Settings	Save	USB drive or local
		Restore	USB drive or file list

Menu 1 (First) >	Menu 2 >	Menu 3>	Menu 4 (Last )
Diagnostics	Powerlines	Powerline 1	Status: [status] DMC: {MAC} HMC: [MAC] MMC: [MAC] Rx rate: [Mbps] Tx rate: [Mbps]
	Network	Status	IP Address
		IP Address	
		IP Mask	
		Mac	
Keysets	Keyset 1 Keyset 2 Keyset 3 Keyset 4	Name: Channel name Talkers: Number of talkers on party line Devices: Number of beltpacks listening on party line Main Stations: Number of Main Stations listening 2-Wire: Number of 2-Wire ports listening 4-Wire: Number of 4-Wire ports listening	

## HKB-4X Speaker Station menu map

Menu 1 (First) >	Menu 2 >	Menu 3>	Menu 4 (Last )
<b>Audio Settings</b>	<b>Headset</b>	<b>Sidetone Gain</b>	<b>Range:</b> 0dB to -18dB <b>Default:</b> -12db
		<b>Headphone Limit</b>	Off + <b>Range:</b> +6dB to -6dB <b>Default:</b> 0db
		<b>Sidetone Control</b>	Tracking Non-Tracking Disabled <b>Default:</b> Tracking
		<b>HS Mic Type</b>	Electret (-15dB) Dynamic (0 dB) Dynamic (-10 dB) <b>Default:</b> Dynamic (0 dB)
	<b>Microphone</b>	<b>Headroom</b>	Normal High <b>Default:</b> Normal
		<b>Contour Filter</b>	Enabled Disabled <b>Default:</b> Enabled
	<b>Front Panel</b>	<b>Loudspeaker Dim</b>	<b>Range:</b> 0dB to --24dB <b>Default:</b> -6db
<b>Station Settings</b>	<b>Preferences</b>	<b>Program ID</b>	Alphanumeric entry



Menu 1 (First) >	Menu 2 >	Menu 3>	Menu 4 (Last )
	<b>Keypad Assign</b>	<b>Keypad 1 – 4</b>	None [conf_name_1], [conf_name_2] <b>Default:</b> [conf_name_1]
	<b>Keypads</b>	<b>Talk #1 Latch</b>	Latching Non-Latching <b>Default:</b> Latching
		<b>Talk #2 Latch</b>	
		<b>Talk #3 Latch</b>	
		<b>Talk #4 Latch</b>	
		<b>Unlatch on Shift</b>	Enabled Disabled <b>Default:</b> Enabled
	<b>Display</b>	<b>OLED Brightness</b>	High Medium Low <b>Default:</b> Medium
		<b>Key Brightness</b>	High / Low High / Off Low / Off Off / Off <b>Default:</b> High / Low
		<b>Screensaver</b>	Enabled Disabled

Menu 1 (First) >	Menu 2 >	Menu 3>	Menu 4 (Last )
			<b>Default:</b> Enabled
<b>Network</b>	<b>Pair to Station</b>	<b>By Name</b> <b>By Address</b>	Separate <b>IP address: xx.xx.xx.xx</b> where <b>x</b> is a numeric value
	<b>Preferences</b>	<b>DHCP</b>	Enabled Disabled <b>Default:</b> Enabled
		<b>IP Address</b>	<b>IP address: xx.xx.xx.xx</b> where <b>x</b> is a numeric value
		<b>Gateway</b>	<b>IP address: xx.xx.xx.xx</b> where <b>x</b> is a numeric value
		<b>Subnet Mask</b>	<b>IP address: xx.xx.xx.xx</b> where <b>x</b> is a numeric value
<b>Administration</b>	<b>Software</b>	<b>Current</b>	HelixNet Speaker Station
	<b>Reset</b>	<b>Reset to Default</b>	Reset Now
		<b>Reboot</b>	Reboot Now
<b>Diagnostics</b>	<b>Powerlines</b>	<b>Powerline 1</b>	Status: [OK or BUSY (according to responses to MME requests)]. DMC:[MAC of powerline modem] HMC: [MAC of local blackfin processor] Rx rate:[Mbps] Tx rate:[Mbps] Status:[status] IP Addr [IP Address] IP Mask [Subnet Mask] MAC:[MAC Address]
		<b>Ethernet</b>	

Menu 1 (First) >	Menu 2 >	Menu 3>	Menu 4 (Last )
	<b>Keysets</b>	<b>Keyset 1</b> <b>Keyset 2</b> <b>Keyset 3</b> <b>Keyset 4</b>	Name: Channel name Talkers: Number of talkers on party line Devices: Number of beltpacks listening on party line Main Stations: Number of Main Stations listening 2-Wire: Number of 2-Wire ports listening 4-Wire: Number of 4-Wire ports listening

## HBP-2X Beltpack menu map

Menu 1 (First) >	Menu 2>	Menu 3 (Last )
<b>Audio Settings</b>	<b>Sidetone Gain</b>	<b>Range:</b> 0dB to -18dB  <b>Default:</b> -12dB
	<b>Headphone Limit</b>	Off + <b>Range:</b> +6 to -12dB  <b>Default:</b> 0dB
	<b>Sidetone Control</b>	Tracking Non-tracking Disabled  <b>Default:</b> Tracking
	<b>HS Mic Type</b>	Electret (-15dB) Dynamic (0dB) Dynamic (-10dB)  <b>Default:</b> Dynamic (0dB)

Menu 1 (First) >	Menu 2>	Menu 3 (Last )
		<b>Note:</b> <i>Electret = 35dB fixed gain, non-user adjustable.</i> <i>Dynamic = 50dB fixed gain, non-user adjustable.</i>
	<b>Headroom</b>	Normal High <b>Default:</b> Normal
	<b>Contour Filter</b>	Enabled Disabled <b>Default:</b> Enabled
<b>Belpack Settings</b>	<b>Left Channel</b>	None
	<b>Right Channel</b>	Channel A Channel B Channel C Channel D
	<b>Talk Latch</b>	Latching Non-Latching <b>Default:</b> Latching
	<b>Vibrate On Call</b>	On Off <b>Default:</b> Off
<b>Display Settings</b>	<b>OLED Brightness</b>	High Medium Low <b>Default:</b> Medium
	<b>Key Brightness</b>	High / Low

Menu 1 (First) >	Menu 2>	Menu 3 (Last )	
		High / Off Low / Off Off / Off <b>Default:</b> High / Low	
	<b>Rotate Display</b>	Enabled Disabled <b>Default:</b> Disabled	
	<b>Screensaver</b>	Enabled Disabled <b>Default:</b> Enabled	
Menu 1 (First) >	Menu 2>	Menu 3 (Last )	
<b>Administration</b>	<b>IP Address</b>	<b>IP address:</b> xx.xx.xx.xx where x is a numeric value	
	<b>Software Version</b>	npl-1.0.x, uboot	
	<b>Software Update</b>	npl-1.0.x	
	<b>Reset to Default</b>	Reset Now	
<b>Diagnostics</b>	<b>Hardware</b> Important Note: There are <b>4 levels of Menu</b> for Hardware	Main PCB	Part: [Part_Number] Revision: [Revision] Serial number: [Serial number]
	<b>Powerline</b> Note: <i>Line (partyline) that connects beltpack to the</i>	Status: [OK or BUSY (according to responses to MME requests)]. DMC:[MAC of powerline modem]	

Menu 1 (First) >	Menu 2>	Menu 3 (Last )
	<i>network (and which also powers the beltpack).</i>	HMC: [MAC of local blackfin processor] MMC: [MAC of the Main Station powerline modem, to which the beltpack is connected] Rx rate: <b>Range:</b> 140 – 150 Mbps Tx rate: <b>Range:</b> 140 – 150 Mbps
	<b>Keysets 1 to 4</b>	Name: Channel name Talkers: Number of talkers on party line Beltpacks: Number of beltpacks listening on party line Main Stations: Number of Main Stations listening 2-Wire: Number of 2-Wire ports listening 4-Wire: Number of 4-Wire ports listening

**Table 16-1: HBP-2X Beltpack**

## 17 Cabling reference

You can connect HBP-2X Beltpacks using:

- A wide range of standard microphone (intercom) cable types (16 AWG – 26 AWG).
- CAT5, CAT5e and CAT6 cable types.

XLR cable	CAT5/6 cable
Pin 1	Pin 1 and Pin 2
Pin 2	Pin 3, Pin 5 and Pin 7
Pin 3	Pin 4, Pin 6 and Pin 8

**Table 17-1 Recommended cabling scheme**

Clear-Com recommends the following cable types:

- Belden 9207 for fixed installation
- Belden 9463F for portable installations

**Note:** Cat 5 screen should be connected to chassis at one end of cable only.

**Note:** Clear-Com recommends the use of shielded twisted pair cabling.

You can also mix CAT cables and microphone cables when connecting to the HMS-4X Main Station. For example, you might use CAT cables to trunk long distances, and flexible microphone cables to connect HBP-2X Beltpacks to bulkheads.

**Note:** The cabling information provided in this guide is for guidance only. For in-depth, tailored advice on cabling, Clear-Com recommends that you contact your Clear-Com representative.

### 17.1 Interoperability

The optional interface modules (two-wire, four-wire, 10/100BaseT Ethernet and Fiber Channel) for the HMS-4X Main Station enable interoperability with your existing communications infrastructure.

You can connect the HMS-4X Main Station to:

- Two-wire intercom systems and devices (including Encore and RTS) using standard microphone cable (16 AWG – 26 AWG).
- Four-wire intercom systems and devices (including Eclipse) using Ethernet (CAT) cable.

**Tip:** For more information about integrating HelixNet Partyline into your existing communications infrastructure, see **13 Connecting to Other Intercom Systems**.

## 17.2 Cable capacitance versus distance

Standard microphone cables impose distance limitations at their upper limits due to cable capacitance.

If your priority is audio quality, experiment with attaching one or two fewer devices to each line. Your choice of topology (daisy chain, star or tree) may also impact audio quality over distance.

Manufacturer	Cable type	Gauge (AWG)	Style	Attenuation / 100m
Belden	9463f	20	Std	16 dB
Belden	9207	20	Std	9 dB
Belden	1533P	24	Cat5e	11 dB

Table 17-2: Cable capacitance



### 17.2.1.1 Quick reference: Cable capacity versus distance

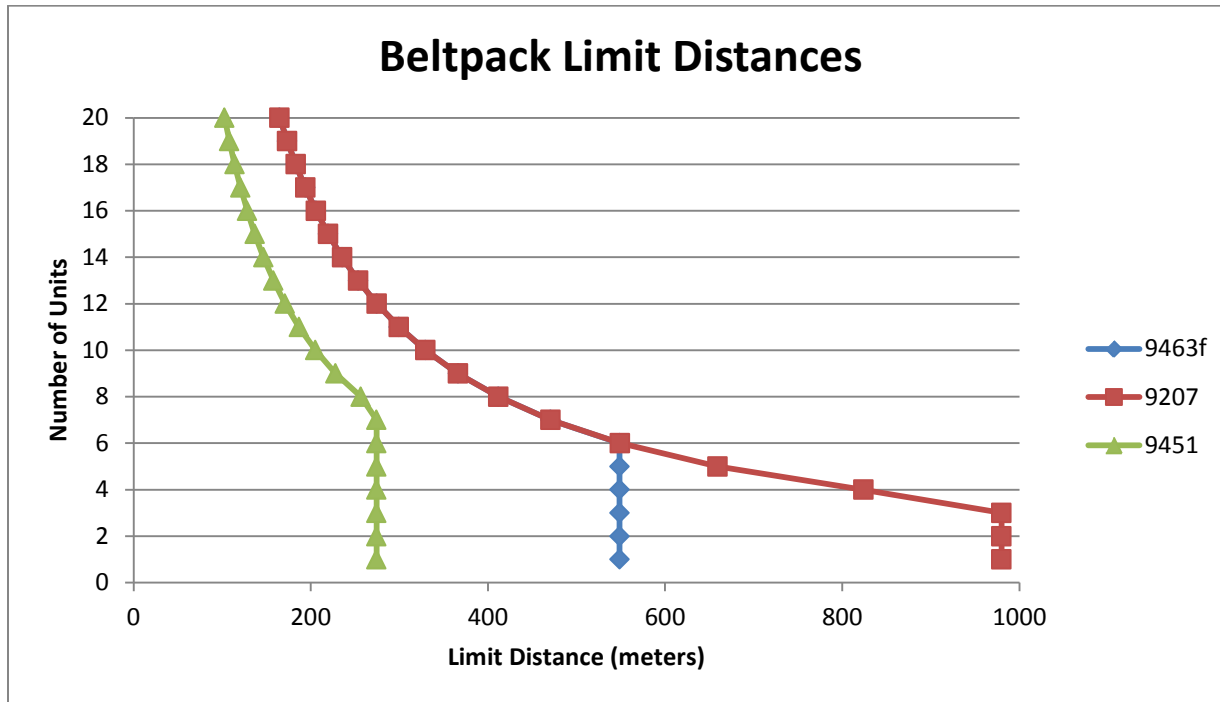

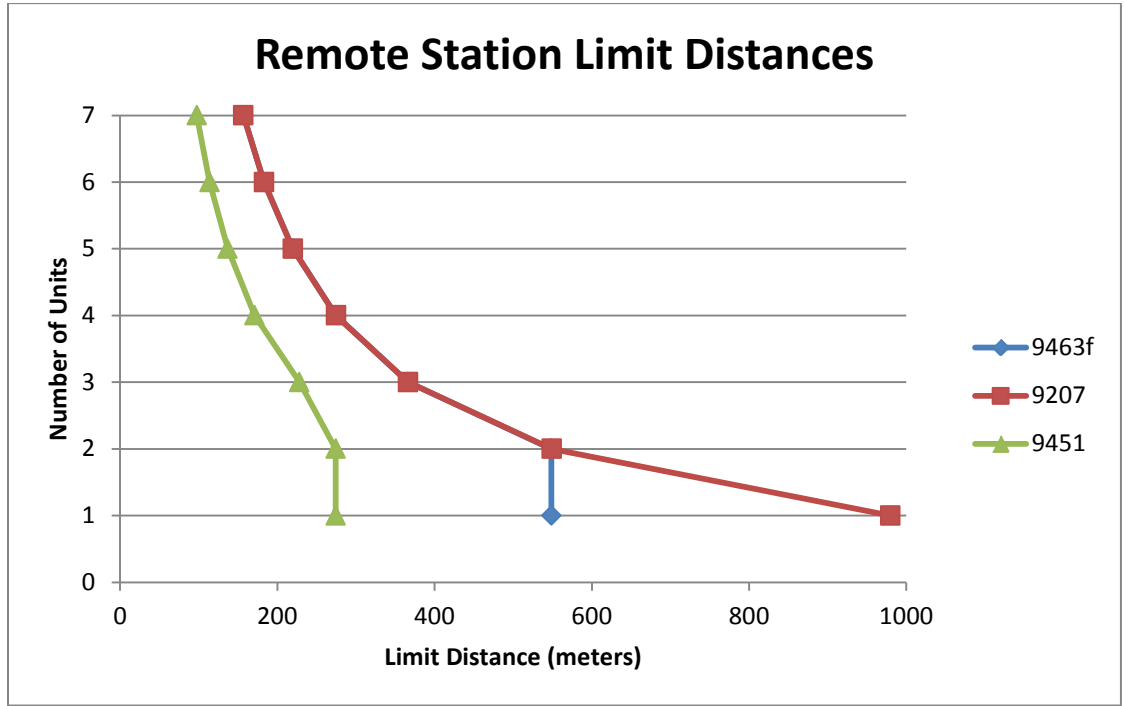

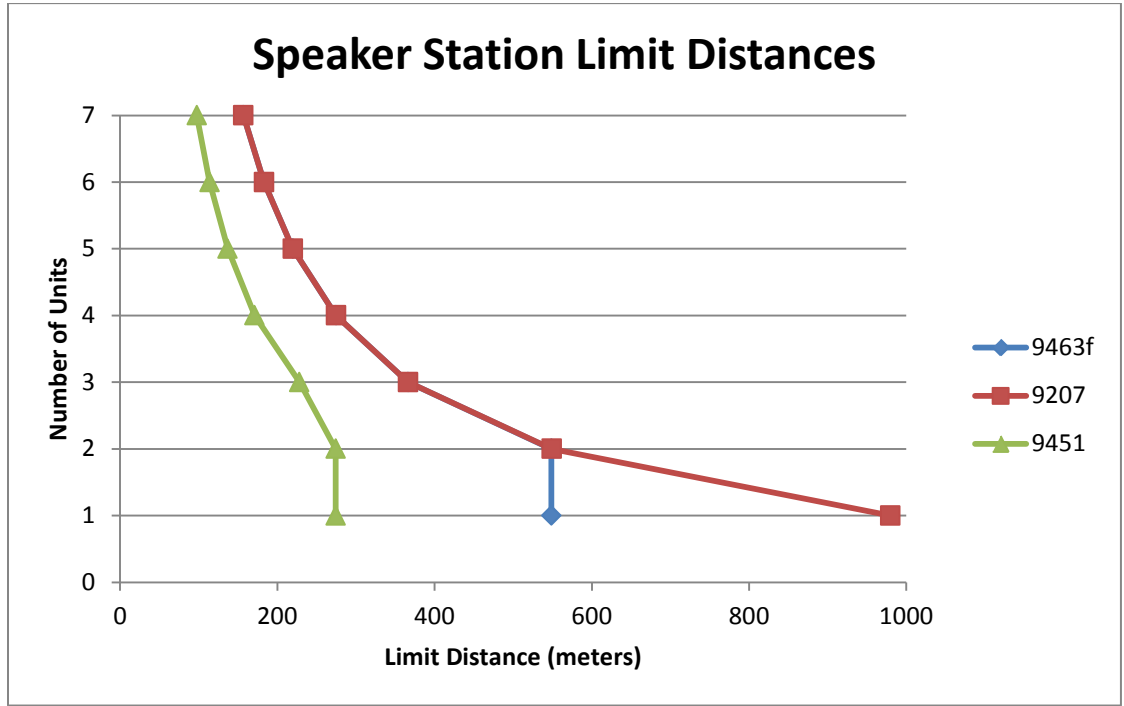

**Note:** The above graphs are intended as a general guide only. Actual cable performance may vary, depending on the conditions and complexity of the installation.

## 18 Troubleshooting

Issue	Solution
<p><b>Why are the Talk keys flashing periodically?</b></p>	<p>Flashing Talk keys may indicate a fault in the cable. Check the cable for short-circuit conditions and replace if necessary.</p>
<p><b>The Call functionality on my analog beltpack is no longer working.</b></p>	<p>HelixNet Partyline operates at different voltage levels than analog two-wire partyline systems. The analog beltpack may have been damaged if it was connected to a HelixNet Main Station partyline port. Contact Clear-Com for repair options.</p>
<p><b>I cannot pass audio to wired / wireless intercom equipment over the Two-wire module.</b></p>	<p>Two-wire option modules require an external power supply. See <b>13 Connecting to Other Intercom Systems</b>.</p>
<p><b>Why do I hear an echo when interfacing via a two-wire audio port?</b></p>	<p>Run auto-nulling. Ensure that all unused Talk keys in the system are unlatched.</p>
<p><b>Echo occurs even after Two wire module has been auto-nulled.</b></p>	<p>Check to ensure all open Talk keys are not latched and re-null.</p>
<p><b>There is no audio or only partial audio (send or receive, but not both) between other audio systems / sources connected over four-wire.</b></p>	<p>Check the cable used to connect the equipment. HelixNet to Eclipse four-wire connections only require a standard CAT cable, whereas other four-wire connections (to Tempest™, CellCom / FreeSpeak, and other systems) require an audio crossover cable. See:</p> <ul style="list-style-type: none"> <li>• <b>2.2.1 HMS-4X Main Station rear panel: Interface modules</b></li> <li>• <b>13 Connecting to Other Intercom Systems</b></li> </ul>
<p><b>Line 1 (or Line 2) LED is blinking red.</b></p>	<p>There is a short-circuit somewhere on that Powerline. Unplug everything from that Powerline and add cables and Beltpacks one at a time until you find the short-circuit.</p>

<p><b>Line 1 (or Line 2) LED is steady red and one or more Beltpack has no bars showing up for signal strength.</b></p>	<p>There are digital errors or there is cross-talk on that Powerline. Look at the Diagnostics-&gt;Powerlines-&gt;Powerline 1(or 2) page.</p> <p>If the number of Beltpacks showing there is greater than what you physically connected to that Powerline, cross-talk is happening between the Powerlines. Make sure you are using properly shielded Mic cables or Cat cables.</p> <p>If the number of Beltpacks showing there does match what you physically connected to that Powerline and errors or high collision rate is displayed, verify that you don't exceed the number of Beltpacks per Powerline or distance as per the Cable capacity versus distance table.</p>
<p><b>I inserted my USB drive with a .ccb file on it and the Administration-&gt;Software-&gt;Update menu shows "None".</b></p>	<p>Make sure that your USB drive is formatted with at least one partition. Make sure your .ccb file is in the root directory of the first partition on your USB drive. If not you can run diskpart on Windows Vista and later versions of Windows to create a partition.</p>
<p><b>I upgraded to 1.1 but I cannot see the Networking menu.</b></p>	<p>Make sure you properly inserted an Ethernet or Fiber module in one of the option module slots. You can verify that they are detected by looking at the Modules Settings menu.</p>
<p><b>I powered up two Main Stations and they are not showing up in the Networking &gt; Stations list.</b></p>	<p>Make sure your Ethernet or Fiber cable is properly connected to a router, a switch or another Main Station. There is a green LED beside each Ethernet and Fiber port to indicate that the connection is fine. Look at each station IP address and Subnet Mask under Networking &gt; Preferences and make sure that they are part of the same subnet. Also make sure that their IP address is different from any other device on your IP network.</p>

**Table 18-1: Troubleshooting**