



# SD Series Software Reference Manual

Software Reference Version A for Software Versions 5.0.680+

## Copyright © 2014 Digico UK Ltd

### All rights reserved.

No part of this publication may be reproduced, transmitted, transcribed, stored in a retrieval system, or translated into any language in any form by any means without the written permission of Digico UK Ltd. Information in this manual is subject to change without notice, and does not represent a commitment on the part of the vendor. Digico UK Ltd shall not be liable for any loss or damage whatsoever arising from the use of information or any error contained in this manual.

All repair and service of the SD products should be undertaken by Digico UK Ltd or its authorised agents. Digico UK Ltd cannot accept any liability whatsoever for any loss or damage caused by service, maintenance, or repair by unauthorised personnel.

### Software License Notice

Your license agreement with Digico UK Ltd, which is included with the SD product, specifies the permitted and prohibited uses of the product. Any unauthorised duplication or use of Digico UK Ltd software, in whole or in part, in print or in any other storage and retrieval system is prohibited.

### Licenses and Trademarks

The SD logo and SD name are trademarks, and Digico UK Ltd and the Digico UK Ltd logo are registered trademarks of Digico UK Ltd. Microsoft is a registered trademark and Windows is a trademark of Microsoft Corp.

Digico (UK) Ltd  
Unit 10  
Silverglade Business Park  
Leatherhead Road  
Chessington  
Surrey  
KT9 2QL  
England  
Telephone: +44 (0)1372 845600  
Fax: +44 (0)1372 845656  
Email: sales@digiconsoles.com  
WWW: http://www.digico.biz

### Manual Issue and Date: Issue A - 7th April 2014 - For Version 5.0.680+ Software

### Licence Agreement

**"Product":** SD software product produced by Digico UK Ltd intended for use on Target Platform identified below.

**"Target Platform":** Digico SD Digital Console systems.

In return for the payment of the one-time fee, the Customer (identified at the end of this Agreement) receives from Digico UK Ltd a licence to use the Product subject to the following terms and conditions.

1. The Product may be used without time limit by the Customer on the Target Platform.
2. The Customer must register the Product with Digico UK Ltd. Registering the Product is deemed an acceptance of the terms and conditions in this agreement.
3. The Product and its licence are not transferable, and the Customer is not permitted to onward-license to any third party. The Customer indemnifies Digico UK Ltd against any and all claims and actions arising from third party use of copies of the Product made by the Customer.
4. The Customer agrees not to attempt to decompile the object code of the Product otherwise than in circumstances specifically provided for by law, and then only after consultation with Digico UK Ltd.
5. The Customer agrees not to use, or licence the Product for use, with equipment other than the Target Platform.
6. The Customer agrees not to modify the Product without the prior written consent of Digico UK Ltd.
7. This Agreement applies to any enhancement or upgrades that may become available for the Product.
8. This Agreement does not transfer any right, title, or interest in the Product to Customer except as specifically set forth herein.
9. Digico UK Ltd reserves the right to terminate this Agreement upon breach, in which event Customer shall thereafter only be authorised to use the Product to the extent that its contractual commitments to third parties require and then only where such commitments relate to use of the Product as authorised in the foregoing provisions of the Agreement.

**LIMITED WARRANTY** - Digico UK Ltd warrants for a period of 1 year from the date of purchase of the Product, the Product will reasonably execute its programming instructions when properly installed on the Target Platform. In the event that this Product fails to execute its programming instructions during the warranty period, the Customer's remedy shall be to return the Product to Digico UK Ltd for replacement or repair at Digico UK Ltd option. Digico UK Ltd makes no other express warranty, whether written or oral with respect of this Product.

**LIMITATION OF LIABILITY** - Except as otherwise expressly provided by law, (a) the remedies provided above are the Customer's sole and exclusive remedies and (b) Digico UK Ltd shall not be liable for any direct, indirect, special, incidental, or consequential damages (including lost profit whether based on warranty, contract, tort, or any other legal theory.)

This agreement is made under the Laws of England.

**LICENCE NO:** .....

**REGISTRATION DATE:** .....

# Contents

<b>1.1 Introduction to Channel Types .....</b>	<b>1-2</b>
<b>1.2 Channel Input Setup - Common Elements .....</b>	<b>1-2</b>
1.2.1 Channel Strip Input Area .....	1-2
1.2.2 Channel Delays .....	1-2
1.2.3 DiGiTube/Warmth .....	1-3
1.2.4 Naming Channels and Busses .....	1-3
1.2.5 Channel Safes .....	1-4
1.2.6 Copy Channels .....	1-4
1.2.7 Channel Presets .....	1-6
1.2.8 Channel Solos .....	1-7
<b>1.3 Channel Output and Inserts - Common Elements .....</b>	<b>1-8</b>
1.3.1 Channel Strip Output Area .....	1-8
1.3.2 Channel Strip Insert Areas .....	1-9
1.3.3 Console Output and Insert Routing .....	1-9
1.3.4 FX Presets .....	1-10
<b>1.4 Input Channel Specific Functions .....</b>	<b>1-10</b>
1.4.1 Trim and Track .....	1-10
1.4.2 Input Routing .....	1-11
1.4.3 Input Configuration .....	1-11
1.4.4 Channel Metering .....	1-12
1.4.5 Output Routing .....	1-12
1.4.6 Aux Busses and Assignable Controls .....	1-13
1.4.7 Group Outputs .....	1-14
1.4.8 Direct Outputs .....	1-14
<b>1.5 Output Channels Specific Functions .....</b>	<b>1-14</b>
1.5.1 Unfolding Channels .....	1-14
1.5.2 Group Channels Specific Functions .....	1-15
1.5.3 Aux Channels Specific Functions .....	1-16
1.5.4 Matrix Channels Specific Functions .....	1-17
<b>1.6 Channel Signal Processing .....</b>	<b>1-17</b>
1.6.1 Channel Filters .....	1-17
1.6.2 Input Channel EQ .....	1-17
1.6.3 Output Channel EQ .....	1-20
1.6.4 Channel Dynamics .....	1-20

- 1.7 LCD Functions .....1-22**
  - 1.7.1 Introduction to LCD Functions .....1-22
  - 1.7.2 Solo .....1-23
  - 1.7.3 Solo Choice .....1-23
  - 1.7.4 GANG .....1-23
  - 1.7.5 JOIN CG .....1-24
  - 1.7.6 Assign Faders .....1-24
  - 1.7.7 Unassign Faders .....1-24
  - 1.7.8 Swap Faders (SD5/SD7) .....1-24
  - 1.7.9 Move Faders (SD5/SD7) .....1-25
  - 1.7.10 Copy Bank From .....1-25
  - 1.7.11 Copy Bank To .....1-25
  - 1.7.12 Clear Bank .....1-25
  - 1.7.13 Create Multi .....1-25
- 1.8 Multi Channels .....1-25**
- 2.1 System Menu .....2-2**
  - 2.1.1 Diagnostics .....2-2
  - 2.1.2 Oscillator .....2-2
  - 2.1.3 GPIO Relays .....2-2
  - 2.1.4 Security .....2-3
  - 2.1.5 Signal Over Indicators .....2-4
  - 2.1.6 Overview Clear Screen .....2-4
  - 2.1.7 Keyboard Help .....2-4
  - 2.1.8 F10: Reset FX .....2-4
  - 2.1.9 F11: Reset Engine .....2-4
  - 2.1.10 F12: Reset Surfaces .....2-4
  - 2.1.11 Set Date & Time .....2-4
  - 2.1.12 Quit to Windows (SD5, SD7) .....2-4
  - 2.1.13 Restart (SD5, SD7) .....2-4
  - 2.1.14 Shutdown .....2-4
  - 2.1.15 Shutdown All .....2-4
- 2.2 Files Menu .....2-5**
  - 2.2.1 Templates .....2-5
  - 2.2.2 Session Structure .....2-5
  - 2.2.3 Load Session .....2-7
  - 2.2.4 Save Session .....2-9
  - 2.2.5 Save As New File .....2-9
  - 2.2.6 Load Presets .....2-10
  - 2.2.7 Save Presets .....2-10
  - 2.2.8 Global Set To Defaults .....2-11

---

2.2.9 Session Notes .....	2-11
2.2.10 Session Report .....	2-11
<b>2.3 Layout Menu .....</b>	<b>2-12</b>
2.3.1 Fader Banks .....	2-12
2.3.2 The Overview Display .....	2-13
2.3.3 Channel List .....	2-13
2.3.4 Set Spill .....	2-15
2.3.5 Transport Control .....	2-15
<b>2.4 Snapshots Menu .....</b>	<b>2-16</b>
2.4.1 Storing a Snapshot .....	2-16
2.4.2 Recalling a Snapshot .....	2-16
2.4.3 Replacing a Snapshot .....	2-17
2.4.4 Editing Multiple Snapshots .....	2-17
2.4.5 Moving a Snapshot .....	2-17
2.4.6 Renaming a Snapshot .....	2-17
2.4.7 Renumbering Snapshots .....	2-18
2.4.8 Deleting a Snapshot .....	2-18
2.4.9 Snapshot Undo .....	2-18
2.4.10 Snapshot Groups .....	2-18
2.4.11 Global Recall Scope .....	2-20
2.4.12 Individual Snapshot Recall Scope .....	2-20
2.4.13 Snapshot Recall Times .....	2-21
2.4.14 Snapshot Crossfades .....	2-22
2.4.15 Snapshots and MIDI .....	2-22
2.4.16 MIDI Devices .....	2-23
2.4.17 MIDI Program and MIDI List .....	2-23
2.4.18 Snapshot GPO Relays.....	2-24
2.4.19 Surface Offline & Snapshot Editing (Not SD11) .....	2-25
2.4.20 Auto Update .....	2-25
2.4.21 Snapshots & MTC .....	2-25
2.4.22 Snapshot Notes .....	2-26
2.4.23 Snapshot Locked .....	2-26
<b>2.5 Options .....</b>	<b>2-27</b>
2.5.1 Surface .....	2-27
2.5.2 Faders .....	2-28
2.5.3 Solo .....	2-29
2.5.4 Delays .....	2-30
2.5.5 Disable .....	2-30
2.5.6 Brightness .....	2-31
2.5.7 Meters .....	2-31

- 2.5.8 Console .....2-32
- 2.5.9 Status .....2-33
- 2.6 FX .....2-34**
  - 2.6.1 The Master FX Display .....2-34
- 2.7 Matrix Menu .....2-35**
  - 2.7.1 The Matrix Panel .....2-35
- 2.8 Graphic EQs Menu .....2-37**
  - 2.8.1 Graphic EQ Panel.....2-37
  - 2.8.2 Ganging Graphic EQs .....2-37
  - 2.8.3 Graphic EQ ALL Button .....2-38
  - 2.8.4 Graphic EQ Presets .....2-38
- 2.9 Control Groups .....2-39**
  - 2.9.1 The Master Control Groups Display .....2-39
  - 2.9.2 Control Group Fader Modes .....2-40
  - 2.9.3 Control Group Mute Functions .....2-41
- 2.10 Solos Menu .....2-41**
  - 2.10.1 The Solo Panel .....2-41
  - 2.10.2 The No Solo Setup Display .....2-42
  - 2.10.3 Assigning Solo Busses to Faders .....2-43
  - 2.10.4 Solo Outputs Routing .....2-43
  - 2.10.5 Headphone Outputs .....2-43
  - 2.10.6 Solo Meters .....2-43
  - 2.10.7 Solo As an Input Source .....2-43
- 2.11 Network and Mirroring .....2-44**
  - 2.11.1 Network Configuration .....2-44
  - 2.11.2 Mirroring for the first time .....2-44
  - 2.11.3 Mirroring Mode .....2-45
  - 2.11.4 Mirroring with a laptop PC .....2-45
- 2.13 Setup Menu .....2-46**
  - 2.13.1 Audio I/O .....2-46
  - 2.13.2 Port Selection .....2-46
  - 2.13.3 Port Hardware Configuration .....2-47
  - 2.13.4 Port Control .....2-47
  - 2.13.5 The Socket Display .....2-47
  - 2.13.6 Socket Conforming .....2-47
  - 2.13.7 Group and Socket Names .....2-48
  - 2.13.8 Socket Options .....2-48
  - 2.13.9 Copy Audio .....2-49

2.13.10 Audio Sync .....	2-50
2.13.11 Timecode & Transport .....	2-50
2.13.12 Macros .....	2-51
2.13.13 The Macro Editor .....	2-52
2.13.14 Talkback .....	2-54
2.13.15 Text Chat (SD5, SD7) .....	2-55
2.13.16 Video Link (SD7 Only) .....	2-56
<b>3.1 Console Audio Connections .....</b>	<b>3-2</b>
<b>3.2 Multi-Console setups .....</b>	<b>3-2</b>
3.2.1 FOH & Mons sharing a stage DiGiRack (MADI) .....	3-2
3.2.2 FOH & Mons sharing a stage SD Series Rack (MADI) .....	3-3
3.2.3 FOH & Mons sharing DiGiRacks (Opto V220) .....	3-4
3.2.4 FOH & Mons sharing SD Series Racks (Opto V221) .....	3-5
<b>A1.1 Optocore V221 - Introduction .....</b>	<b>A1-4</b>
A1.1.1 System Overview .....	A1-4
A1.1.2 Opto V220 (DiGiRacks) and Opto V221 (SD Racks) .....	A1-5
A1.1.3 Replacing DiGiRacks with SD Racks .....	A1-5
A1.1.4 Replacing SD Racks with DiGiRacks .....	A1-7
<b>A2.1 The Audio IO Panel .....</b>	<b>A1-8</b>
A2.1.1 Layout .....	A1-8
A2.1.2 Quick Start Guide for SD V370+ and Optocore V221 .....	A1-8
A2.1.3 Audio Sync .....	A1-12
A2.1.4 The Port List .....	A1-12
A2.1.5 Managing Ports .....	A1-12
A2.1.6 SD Rack Splits .....	A1-13
<b>A3.1 SD Series Dual Loop Optocore Systems .....</b>	<b>A1-13</b>
A3.1.1 Important Considerations .....	A1-13
A3.2.1 Setting up a Dual Loop System .....	A1-14
A3.2.3 Console Snd/Rcv Ports .....	A1-14
A3.2.4 Single Loop Console on Loop 2 .....	A1-15

# **SD Series Software Reference**

## **Chapter 1:**

### **Channel Types and Functions**



# Chapter 1 - Channel Types

## 1.1 Introduction to Channel Types

This chapter describes all of the functions available within the SD channel strips. The first two parts of the chapter will examine the Input/Setup and Output sections of each of the types of channel strip, and the third part will cover the in-channel signal processing, which functions in precisely the same way on each channel type. Those elements which are common to each channel type are dealt with first, and then those elements which are specific to a channel type are dealt with separately. In order to understand this chapter, you will find it helpful to have read the "Getting Started" manual for your console.

## 1.2 Channel Input Setup - Common Elements

### 1.2.1 Channel Strip Input Area .....

The channel strip input section is located at the top of the channel strip (shown below for an Input channel). This is where the channel inputs, snapshot safes, and solo bus feeds are configured. Some basic controls are displayed in the channel strip. However, most of the input parameters are contained in the channel **Setup** display, accessed by touching the channel's input or filters areas at the top of the screen. The **Setup** display also contains a number of channel configuration elements.



*Note that channels without an external input selected display a simpler input section than that shown here. Note also that input channels can display a channel meter which hides the input and filters sections of the channel strip. Press the 'assign' down button to close the meter view.*

The large pot at the top of the input area of the main channel strip controls the input level, and can be accessed using the encoder immediately above the channel strip (SD7,8,10) or using the "quick select" buttons (SD 5, 9,11). For Input channels which have ADC's assigned to their inputs, this remotely controls the analogue gain of the mic pre-amp in the I/O rack. For all other input types, this is a digital level trim. The gain value is displayed to the right of the level pot.

To the left of the pot there is a phase reverse button which is grey when inactive and red when switched in.

### 1.2.2 Channel Delays .....

Delay controls are found in the **Setup** display. The delay can be switched on using the **on** button, which is ringed in red to indicate that it is on. The left-hand blue pot controls the course delay amount in milliseconds. The right-hand blue pot enables fine adjustments to be made to this amount, measured in samples. Both pots can be assigned to encoders by touching the on screen control.



It is also possible to enter a specific delay amount using a numeric keypad. To do this, touch the keypad symbol to the right of the delay on button in the **Setup** display, select the desired units from the buttons to the right of the number buttons (**seconds**, **feet**, **metres**, **frames** or **bpm**) enter to amount using the keypad, and press **OK**.

*Note that altering the delay units in this keypad display will change them wherever they appear on the console.*

## 1.2.3 DiGiTube/Warmth .....

The **digitube** area of the Channel Setup panel allows for the emulation of the non-linearities of a valve amplifier: At low levels the valve is almost linear and at high levels the valve starts to compress and exhibits “soft clipping.”



Click the **on** button to activate. The number of times the tube can be activated is dependent on which SD console you are using. Please refer to the Console comparison chart in the appendix for more information.

The **drive** control increases the gain into the valve and automatically reduces the output gain so that the volume stays the same (like gain tracking); the indicator shows how hard you are driving the valve and hence how much distortion is being introduced.

The **bias** control sets the symmetry of the distortion: At 0 the distortion is symmetrical and produces largely 2nd harmonic (and even) distortions; as the **bias** is increased, the distortion becomes more and more asymmetrical and starts adding 3rd (and odd) harmonic distortions. In effect, the **bias** controls the characteristics of the distortion; a lower bias produces a softer distortion, whereas as higher bias produces a harder distortion.

The **warmth** control (which is hidden if the **on** button is pressed) switches DIGItube on, sets it to its default settings, and hides the rest of the controls. There is no limit to the number of times **warmth** can be switched on.

## 1.2.4 Naming Channels and Busses .....

A large number of elements within the console can be custom named. Access to the naming facility is via black and white text boxes with down arrow and keyboard buttons to their right, such as shown here:

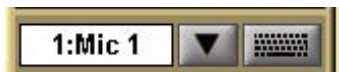

To create a name manually, touch the text box or the keyboard symbol to its right to bring up a QWERTY keyboard display. This keyboard includes standard **Caps**, **Shift** and **Delete** functions, as well as **Cut**, **Copy** and **Paste** functions which can be used to move name text between channels. The arrow buttons in the bottom left-hand corner of the keyboard display move the cursor within the text box. Create the new name, either using the on-screen keyboard display or the external keyboard, and press **OK**. To close the keyboard display without changing the name, press **CAN**. To move the keyboard display to the following channel, press **Next** (or **TAB** on the external keyboard).

The **Channel Name** display enables commonly used words to be inserted quickly without the use of the keyboard. This facility is available not only when naming channels but also when naming other elements. To open the **Channel Name** display, touch the down arrow immediately to the right of the **Setup** display's channel name text box.

Channel Name										CLEAR	CLOSE	
CAPS	Initial Cap	custom	edit									
12 string	bot	crash	girls	keys	mic	piano	snare	tom		0		
ac	boys	di	glock	kick	mid	princ	soprano	top		1		
acoustic	brass	direct	gong	kit	midl	prog	spare	track		2		
alto	bv	double	gtr	l&r	mono	rack	stage	trombone		3		
audience	cd	drums	guitar	lead	mp3	rear	stalls	trumpet		4		
backing	cello	far	hand	left	near	reverb	strings	vola		5		
backup	choir	feed	harmony	lo	noise	rhythm	sub	violin		6		
band	chorus	fill	hat	loops	o/h	ride	surr	vocal		7		
baritone	circle	floor	head	madl	oboe	right	sync	vxx		8		
bass	clarinet	flute	hi	main	opto	sax	synth	wind		9		
bongo	click	front	hi-hat	master	organ	seq	tenor	woodwind		L		
booth	cuaga	fx	hurr	md	perc	side	tinga#l	xylophue		R		

Touching any word from the display inserts that word into the channel name text box. Further words can then be added to the channel name in the same way, divided by a single space. Numeric and L/R identifiers can be added from the column down the right-hand edge of the display. Text can be entered in CAPS or Initial Caps by pressing the **CAPS** and **Initial Cap** buttons in the top of the display. If neither of these are selected, all text is inserted in lower case.

**Note that the first text to be inserted from the Channel Name display when it is opened overwrites all previous text.**

**Note also that text that extends beyond the end of the text box will not be visible!**

In addition to the standard word set, a list of user-defined words can be created and inserted by pressing the **custom** button, located next to the **Initial Cap** button. The button lightens to indicate that the custom set is displayed.

# Chapter 1 - Channel Types

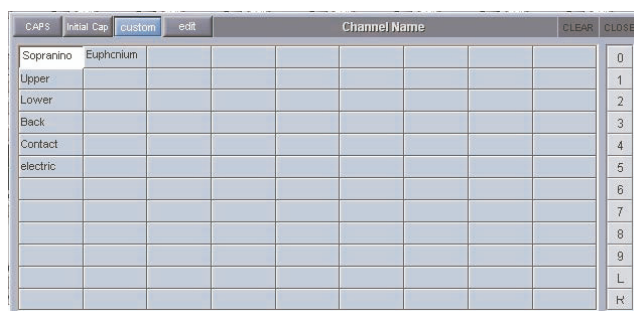

To add a new word to the custom set, touch the box which you want to use and press **edit**, located next to the **custom** button, to bring up a QWERTY keyboard display. Type the required word and press **OK**. In this keyboard display, the **Next** button saves any text inserted in the current box and moves the keyboard to the next box in the custom list. To cancel the keyboard display, press **CAN** within the display, or press **edit** again. The words in the custom list are inserted into the channel name text box in exactly the same way as words in the standard list. Pressing **custom** again returns the display to the standard word set.

**Tip:** As custom names appear in the box in which they are typed, they are not automatically alphabetised. The user may find it helpful to define a system for ordering the custom page.

**Note also that the standard word set cannot be edited.**

The current name can be cleared by touching the **CLEAR** button towards the top right-hand corner of the **Channel Name** display. The **Channel Name** display can be closed by touching the **CLOSE** box, in the top right-hand corner.

## 1.2.5 Channel Safes .....

The **Channel Safes** area of the **Setup** display defines which parts of the channel will not be affected when snapshots are recalled to this channel.



**Note that the above diagram displays the Input channel safes. Output channels display a smaller list of available channel safes.**

Select whichever parts of the channel you want to protect in this way by touching the appropriate button. To cancel a safe, press the relevant button again. The buttons turn red to indicate that they are safed. The presence of safes within the channel is also indicated by the label of the appropriate channel part turning red and the background colour of that channel's name also turning red.

The EQ and dynamics settings can also be safed and unsafed from within the **eq** and **dynamics** displays. The whole channel can also be safed and unsafed by pressing the **SAFE** button at the bottom of on-screen channel (offline software). It is grey to indicate that some elements of the channel are not safed, and red to indicate that the entire channel is safed.

Channel elements which have been safed are indicated by their text displaying red in the channel strip.

**Tip:** When some elements of the channel are safed, a double-press on the **SAFE** button can be used to quickly clear all channel safes (SD5, SD7).

**Note:** Channel safes refer specifically to snapshot recalls and do not protect channel settings when using the copy from, copy to and presets functions described below.

## 1.2.6 Copy Channels .....

The **Channel Settings** area of the **Setup** display allow channel settings to be copied between channels. The left and right arrow buttons are used to move the **Setup** display to adjacent channels.



The **copy from** button allows settings to be copied from other channels to this channel and those to its right: Pressing **copy from** opens up a **Copy Channels** display:

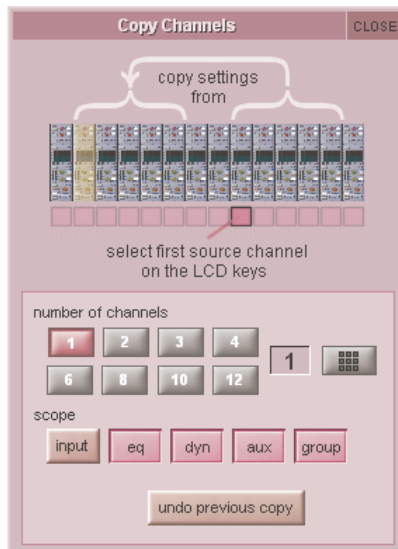

The extent of the channel settings to be copied is selected using the **scope** buttons towards the bottom of the display. Each button lightens to indicate that it is included in the copy function. The number of source channels to be copied is defined either by selecting the appropriate grey numbered button, or by selecting the keypad button to the right of the numbered buttons, typing the required number of source channels into the numeric keypad which appears, and pressing **OK**. Press the LCD button (shown below) on the left-most source channel in order to action the channel copy. If more than one source channel has been selected, the settings of appropriate number of channels to the right of the source channel will copy to the channels to the right of the destination channel (The current Assigned channel).

For example, to copy the EQ settings on channels 1-8 to channels 9-16 respectively:

- Make channel 9 the Assigned channel and touch **copy from**
- In the scope area of the **Copy Channels** display, select only the **eq** button
- Set the **number of channels** to be **8**.
- Press the LCD/select button on channel 1.



# Chapter 1 - Channel Types

The **copy to** button allows settings to be copied from this channel to other channels: Pressing **copy to** opens up a **Copy Channels** display:

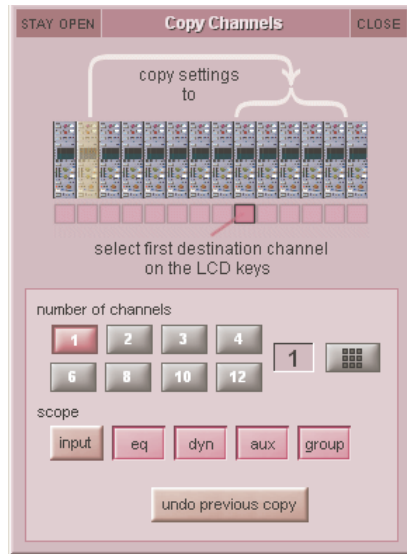

**Note that this is a different Copy Channels display from that opened by the copy from button.**

The extent of the channel settings to be copied is selected using the **scope** buttons towards the bottom of the display. Each button lightens to indicate that it is included in the copy function. The number of destination channels to which this channel's settings will be copied is defined either by selecting the appropriate grey numbered button, or by selecting the button to the right of the numbered buttons, typing the required number of source channels into the numeric keypad which appears, and pressing **OK**. Press the LCD button (shown above) on the left-most destination channel in order to action the channel copy. If more than one destination channel has been selected, the settings of the source channel will copy to the appropriate number of channels to the right of the selected destination channel.

For example, to copy the EQ settings on channel 1 to channels 9-16:

- Make channel 1 the Assigned channel and touch **copy to**
- In the scope area of the **Copy Channels** display, select only the **eq** button
- Set the **number of channels** to be **8**.
- Press the LCD/select button on channel 9.

If a **copy from** or **copy to** function is actioned by mistake, it can be undone by pressing the **undo previous copy** button in the current **Copy Channels** display.

**Tip: Use copy to for copying one channel's settings to a number of other channels; Use copy from to copy the settings of a group of channels to another group of channels.**

## 1.2.7 Channel Presets .....

Presets are used for storing and recalling settings for channels, fx units, graphic EQs and the matrix. While each preset functions slightly differently, this section provides a basic understanding of how to use the various preset displays:



The left-hand column of a preset display contains the available **groups** of presets, and touching one of these groups brings up the list of presets within that group in the column to its right (**name**). The columns to the right of the preset name displays the number of channels whose settings are included in the preset (**chs**) (Channel and Matrix presets only), the date and time it was created or updated (**notes**), and whether or not it is locked (**lock**).

**Note that a presets display will only list presets of the relevant type.**

To recall a preset, touch the name of the **group** containing the preset you wish to recall, and then touch the preset's name. The **recall scope** buttons at the bottom of the some preset displays allow you to select which elements are recalled and which elements remain unchanged. The buttons are included in the recall when they are lit.

To save the current settings as a new preset, touch the group in which you want the preset to be stored and press the **new** button. The new preset is automatically named according to the preset type. To alter the preset's name, type the new name using the keyboard display that appears (or the external keyboard) then, if relevant, touch and edit the number of channels' settings that you want to store in the preset (the default is one channel). Now touch **OK**.

**Note that pressing CAN in the keyboard display will cancel the display but create the new preset with its default name.**

To save the settings as an update of a previous preset, press **update**, touch the preset you wish to overwrite, and press **Yes** in the confirmation display which appears.

**Note that when updating a previous preset, failing to press update will result in the preset you wish to overwrite being recalled, and the settings to be saved being lost.**

To create a new group of presets, press **new group**. A new group will be created, called **group n**, where **n** is the next available preset group number. To alter the group's name, type the new name using the keyboard display that appears (or the external keyboard) and touch **OK**.

**Note that pressing CAN in the keyboard display will cancel the display but create the new group with its default name.**

The **edit name** button allows preset names and group names to be edited, and the preset to be locked, preventing them from being edited, overwritten, or deleted. The button lightens to indicate that it is active. To edit a preset's name, make sure the preset is unlocked (see below), activate the **edit name** button and touch the preset's name. Type the new name in the keyboard display and press **OK**. To edit a preset group name, activate the **edit name** button and touch the group name. Type the new name in the keyboard display and press **OK**.

To lock the preset, activate the **edit name** button and touch the preset's **lock** column. A grey padlock appears, indicating that the preset is now locked. Touching the lock again with **edit name** active unlocks the preset.

To delete a preset, press **delete**, touch the preset to be deleted, and press **confirm**. To delete a consecutive range of presets, press **delete** followed by **select range**, touch the first and last preset to be deleted and press **confirm**. To delete one preset, or a nonconsecutive range, touch each preset to be deleted and press **confirm**. To delete an entire group of presets, press **delete** followed by **select all**, then press **confirm**.

## 1.2.8 Channel Solos .....

SD consoles have two solo busses, and each channel can be assigned to **solo 1**, **solo 2** or both **solo 1** and **2**. If the console was being used for Stage monitors, this would allow, for example, the first solo buss to feed In-Ear monitors and the second solo buss to feed a wedge.

**Note: The solo busses are configured in the master solo displays, accessed by pressing the Solos button at the top of the Master Screen.**



The channel's solo routing is assigned in the section at the bottom section of the channel Setup display. Pressing the green **solo 1** and **solo 2** buttons enables the channel to be routed to solo busses 1 and 2 respectively. The buttons are green to indicate that the solo buss is available, and grey to indicate that it isn't.

**Note that each channel must be enabled for at least one solo buss.**

When the blue **auto solo** buttons are active (indicated by white, rather than grey, text), that channel is automatically routed to that solo buss whenever another channel is soloed to that buss.

**Note that a list of channels with auto solo enabled is displayed in the auto solo section of the master solo display. The auto solo function has to be activated by pressing the blue enabled button below the auto solo list in the master solo display. Auto solo is disabled when in single solo mode.**

**Tip: If you are using effects returns, selecting auto solo can allow soloed tracks to be auditioned with their effects returns.**

## 1.3 Channel Output and Inserts - Common Elements

### 1.3.1 Channel Strip Output Area .....

The channel strip output area makes up the lower half of the Channel Strip panel (shown below for an input channel). This is where the channel output routes are configured (including Aux outputs in the case of Input channels).

Each channel also has two inserts: insert A and insert B. Both inserts follow the format (mono or stereo) of their channel. The channel strip insert areas are located above the **eq** section (**insert A**) and below the **2nd Dynamics** section (**insert B**), and their signals are sent and returned to that position within the signal path: **insert A** is pre-signal processing (but post filters), and **insert B** is post signal-processing. Only one point, either insert A or insert B, can be used per channel on SD9 or SD11.

#### Post-Fade Inserts

Up to 32 mono input channels can have their insert B point switched to a post fader insert point using the button in the Output Setup panel.

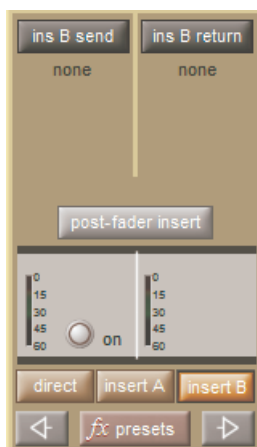

**Note that Multi channels do not have their own insert controls – each multi-channel component's insert points are configured individually.**

Some basic output and insert functions are found in the channel strip. However, most of the output and insert parameters are contained in the channel **Output** display, accessed by touching the channel's output or insert areas.

**Note that on Input channels, an aux display is opened by touching the aux area. To open the Output display, touch in the muting and naming area below the pan control.**



**Note that if there are any multi-channel busses in the Session Structure, the pan display will be different from that shown above.**

For all output channel types, there is a channel meter displayed in the channel strip. For Input channels, this part of the channel strip contains the aux outputs, as shown above. On stereo and multi-channel format channels, symbols below each meter indicates which component is displayed. LFE channels are indicated by a small box with a dot in it.

**Note that input channels can display a meter in the top section of the channel strip.**  
**Meter sources are defined in the Options menu, described in the Master Section**

Below the meters section of output channels, there is an **fx output** button. This button brings up either the controller display for the effects preset that has been assigned, or the **fx Presets** display if no preset has been assigned.

**Note that below the aux section of an Input channel, there is a pan control in place of the fx output button.**  
**When an effects preset has been assigned to that channel's Direct Out, touching this pan control brings up the FX preset controller display.**

Towards the bottom of the channel strip there is a scribble strip text box displaying the channel names.

**Note that the channel naming facility is found in both the channel Setup and Outputs displays.**

Below the channel name, there is indication of the lowest group (**Grp:**) output (along with indication of the lowest direct output (**Dir:**) in the case of Input channels), and indication of any control group (**CG:**) to which the channel belongs.

The on-screen channel has **MUTE** and **HARD** indicators located above the scribble strip. Pressing the worksurface **MUTE** button (above the LCD button) silences all outputs from the channel apart from any which have been assigned pre-mute (this option is available for auxes and direct outs). Pressing the worksurface **2nd Function** button to activate the **HARD** mute silences all outputs from the channel, including those which are assigned pre-mute. A dedicated **HARD** mute button can be found on both SD5 and SD7 worksurfaces.

Immediately below the **HARD** button, there is a numeric display of the channel's main fader value in dB. Below the **MUTE** button there is a **CG MUTE Indicator** which shows when the channel is muted as the result of its membership of a muted **Control Group**. At in the bottom left-hand corner of the channel strip, there is a **GANG** display. To the right of the **GANG** button there is a **SAFE** button. This indicates that one or more of the channel's recall safes have been activated.

### 1.3.2 Channel Strip Insert Areas .....

Channel strip insert areas include a button for switching that insert send on and off. The button is grey when the send is off, and red when it is on.

Below the on/off button, there is a display of the current insert routing. The send route is displayed on the left, prefixed by **S:**, and the return route is displayed on the right, prefixed by **R:**. If no routing has been selected, these areas are blank apart from these prefixes. If the channel is stereo, only the left side of the insert routing is displayed.

### 1.3.3 Console Output and Insert Routing .....

The **Output** displays for all channel types allow direct routing either to the external IO racks, or to one of a variety of internal locations, for both the channel's main output (or direct output in the case of Input channels), and its insert send and return.

In addition to touching inside the output area of the channel strip, it is also possible to open each channel's **Outputs** display from the **Channel Lists** display, opened from the Master Screen's **Layout** menu: Activate the **Edit** button at the base of the display, expand the required channel type by touching its entry in the list, then touch the output column within the required channel row. An outputs display will open within the Master Screen:

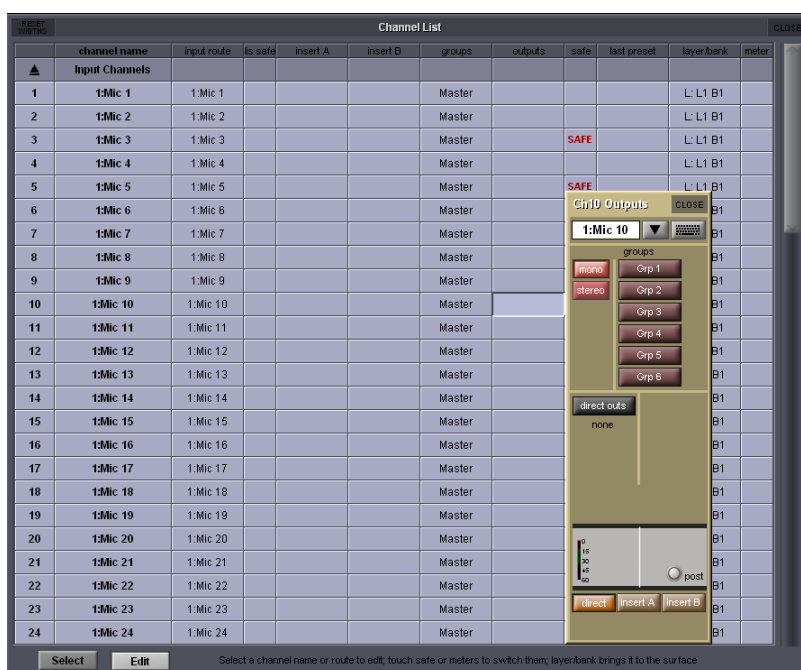



# Chapter 1 - Channel Types

Towards the bottom of the **Outputs** display, there are three buttons marked **output** (direct in Input channels), **insert A** and **insert B**. Selecting one of these buttons assigns that send (or send and return) to the signal routing area above it: When either insert is assigned, the **ins A send** or **ins B send** routing button appears in the left-hand column, and the **ins A return** or **ins B return** routing button in the right-hand column; When the output (direct output in Input channels) is assigned, the **outputs (direct outs** in Input channels) routing button appears in the left-hand column and the right-hand column is left blank. Pressing any of these routing buttons opens a routing display.

An extra button labelled **send+return** is included above the **ports** list in the **Insert Send Route** display button. When this button is activated, the send and return routing is linked for all signals within the **INTERNAL** port: If the **Graphic 1** input is assigned to the insert send, the **Graphic 1** output is automatically assigned to that insert return. Similarly, if it is the return which is manually assigned, the send automatically copies that send assignment. The **send+return** button is grey when inactive and brown when active.

The **mono > mono** and **mono > stereo** buttons are used when routing a mono channel to internal fx units and Waves plug-ins (where available). When **mono > mono** is selected, the channel signal is routed to left side of an fx unit, or to a mono Waves rack input. When **mono > stereo** is selected, the channel is routed to both sides of the fx unit or Waves rack.



### 1.3.4 FX Presets .....

Each channel output or insert send can be sent to an internal FX Unit. Pressing the **fx presets** button at the bottom of the **Outputs** display brings up the **fx Presets** display. The fx preset is applied to whichever channel output is active in the **Outputs** display when the **fx presets** button is pressed: the main channel output (or direct output), insert send A or insert send B:

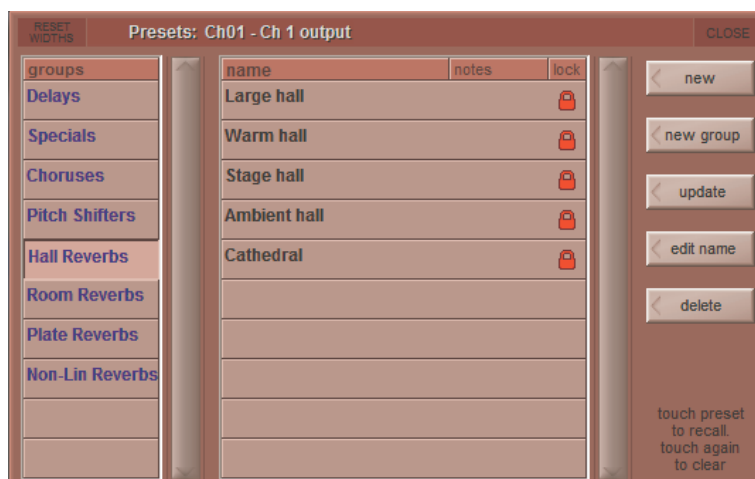

*Note that column widths can be adjusted by dragging their borders within the title row. To return all columns to their default widths, press **RESET WIDTHS**, in the top left-hand corner of the window.*

For more details of SD FX and FX preset management, please refer to the Master Section Chapter

## 1.4 Input Channel Specific Functions

### 1.4.1 Trim and Track.....

On Input channels which a mic or line input, there is a trim section at the bottom of the channel strip's input area, consisting of a smaller pot marked **trim** and a **track** on/off button. The **trim** pot digitally trims the level of the input signal, and the level adjustment is displayed to the right of the pot in dB. If **track** is switched on, the trim level automatically compensates for any adjustments made to the analogue input level: If the analogue input level is increased, the trim level will decrease in order to keep the signal level coming through the channel at the same level. This function is particularly useful when the analogue level is being controlled from another console, such as when this console is running monitor mixes and another console is running Front of House. Control of the **trim** pot and **track** on/off button can be assigned to the encoder and button above/below the channel using the **assign** scrollers to the left of the encoders or the quick select buttons.

### Relative Gain-Tracking - Snapshot Recalls Total Gain

"Relative Gain-Tracking" is implemented as a "Snapshot Recalls Total Gain" option at the bottom of the Snapshot Global Scope panel. When a snapshot recalls an input channel trim, it compares the snapshot's stored analogue gain against the current gain on the channel's input socket. If there's a difference it offsets the value recalled by the trim. This only happens when the socket's rack is in Receive Only, or the analog gain is not in Recall Scope.

1.4.2 Input Routing .....

Inputs are routed using the channel **Setup** display, opened by touching in the input area of the channel strip. It is also possible to open the display from the **Channel List** display, opened from the Master Screen's **Layout** menu: Activate the **Edit** button at the base of the display, expand the required channel type by touching its entry in the list, then touch the output column within the required channel row. A **Setup** display will open within the Master Screen:



The buttons at the top of the channel **Setup** display to define the format of the channel: **mono** or **stereo**.

**Note that Multi-channel formats are configured in a different way from mono and stereo formats, as described later in this chapter**

As the channel format affects a number of functions within the **Setup** display, it is advisable to select the format before any further configuration takes place. The current format of the channel is indicated in the channel strip by the number of meters displayed: One meter for mono channels and two for stereo.

For mono channels, each input channel has two inputs: a **main** input and an **alt(ernative)** input. These are selected using the **main** button in the channel strip. The button is grey when the **main** input is selected and red when the **alt** input is selected. The input can also be selected using the **main** and **alt** buttons towards the top of the **Setup** display. These buttons light to indicate which one is currently selected. For stereo channels, the alternative input becomes the right side of the stereo input, and therefore no **main** and **alt** input selection buttons are shown.



The inputs available on an Input channel include feeds from the external IO racks, the local inputs on the back of the console and a variety of internal signals. Pressing either the **main input** or **alt input** routing button in the **Setup** display opens the **Input Route** display. The signal feeding each input can then be selected as described in the Getting Started section of this manual.

1.4.3 Input Configuration .....

If a channel is stereo, **balance** and **width** controls appear below the **mono** and **stereo** buttons: The left-hand blue pot controls the balance and can be reset to centre by pressing the **centre** button below it. The right-hand blue pot effects the width of the stereo signal, with a range from mono to wide. The width can be reset to stereo by pressing the **stereo** button beneath the **width** pot. The value of the balance and width is displayed to the right of each pot as a percentage divergence.



# Chapter 1 - Channel Types

Stereo channels also have an **m-s** button, located above the input routing button, which switches in a decode function for replaying M-S signals as a normal stereo pair. There are three further buttons in this panel: **L<>R** swaps the channel's left and right outputs, **L>L+R** sends the left signal to both left and right busses, and **R>L+R** sends the right signal to both left and right busses.

## 1.4.4 Channel Metering .....

Channel meters can be displayed in the top section of the Input channel strip, in place of the input and filters areas. To do this, press the **meter (SD7, SD5)**, **rotary assign (SD8, SD10)**, **screen scroll (SD9, SD11)** up button, located on the console worksurface. If these encoders are initially assigned to the trim function, you will need to press the **rotary assign** up button twice to display the meters.



If you adjust any parameter which is hidden by the meters, the meters will be hidden momentarily, allowing adjustments to be viewed.

## 1.4.5 Output Routing .....

Signals can be fed from Input channels to four different places: aux busses, group busses, insert sends and direct outputs. Insert routing and basic direct output routing are described in the Getting Started Manual.

The top half of the output section of the Input channel strip contains the aux buss controls, as previous described. Below the auxes, there is a pan control, affecting the relative levels of the channel's left and right outputs to any stereo routing destinations. The controls are formatted to match the format of the buss with the most components:

- Where there are only stereo or LCR busses, a simple pan slider is shown (see below left). Move the slider to adjust the pan. A text box indicates the panning position as a percentage from the centre towards the right.
- Where there are LCRS busses, a two-dimensional panning scope is shown (see below centre). Move the central grey square to adjust the position. Text boxes indicate the left-right and front-back position.
- Where there are 5.1 busses, a two-dimensional panning scope is shown, along with a pink **LFE** level control (see below right). Move the central grey square to adjust the position. Text boxes indicate the left-right and front-back position, as well as the LFE gain.

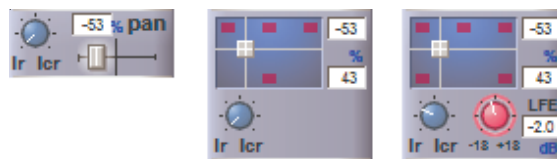

There is also an **LR/LCR Blend** control. This control allows adjustment of the amount of signal that is sent to the centre leg (where one exists) of a surround buss. In the extreme left **LR** position, no signal will go to the centre leg:

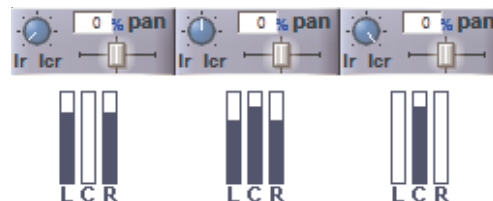

The pan of the Assigned channel can be controlled using the worksurface joystick (SD5,7,8,10). The pan control can also be assigned to one of the encoder rows. LR/LCR Blend is adjusted using the 2nd function button.

**1.4.6 Aux Busses and Assignable Controls .....**

Within an Input channel strip, each aux send has a level trim and on/off switch to the right. The switch is grey to indicate that the send is off, and red to indicate that it is on. The trim level is displayed in dB on the right of the channel strip, underneath the aux number.

There are three places within the channel from which the aux sends can be fed, as indicated by the source display immediately to the right of the level trim:

- PRE**            Pre-fader
- POST**         Post-fader
- Pre-M**         Pre-mute (and pre-fader)

The source position can be changed by pressing the worksurface **2nd function** button and using the switches below the aux send encoders. The source for each aux can also be adjusted globally via the aux channel's **Setup** display.

On stereo aux sends, there is a pan control to the right of the on/off switch. This can be adjusted by pressing the worksurface **2nd function** button and using the rows of encoders below the worksurface screen. The pan controls for each aux can be globally linked to the channel fader via the aux channel's **Setup** display.

At the bottom of the assigned channel SD7 worksurface controls, there are four dedicated aux encoders with buttons, which control four contiguous aux send pots and on/off switches for the Assigned channel:



The auxes controlled by these encoders and buttons can be selected using the scroll buttons to the left of the top encoder, and is indicated by purple ring on the on-screen aux sends.

**Note that this assignment is channel specific and will be recalled if the Assigned channel is changed and returned to that channel.**

The encoders and buttons immediately below the Channel Strip can be used to control either the aux sends, or a separate function. This function is referred to as the 'locked' function, as it does not change when the auxes are moved. The button at the end of each row, next to the LCD display, flips the assignment of that row between the aux sends and the locked function. Touching any on-screen aux send assigns the highest available encoder row to that send, and assigns any other available encoder rows to the aux sends below it. The scroll button outside the bottom left-hand corner of the screen can also be used to change which auxes are assigned to the encoders. (SD5,7,8,10)

**Note that only six auxes can be displayed in the Channel Strip panel at once. The panel will always display the auxes assigned to the encoder rows below it. This means that the auxes controlled by the dedicated aux encoders in the channel worksurface controls may not be visible.**

By default, the encoders control the aux level and the button controls the aux on/off status. However, by pressing the **2nd function** button (located on the surface), the button becomes the aux's source selector (toggling between **PRE**, **POST** or **Pre-M**), and the encoder becomes the pan control of a stereo channel. On mono auxes, the encoder has no second function.

It is also possible to show all of the aux sends for a channel in a single display and assign them to the rotaries beneath the screen. This is done by assigning the required channel to the aux controls (the assigned auxes will be displayed in dark purple with a dark purple surround) then touching one of the assigned auxes. The layout of the display indicates which encoder each aux is assigned to; if there are more sends than rotaries, the assignments becomes scrollable using the **Screen Scroll** function. The Picture below shows an SD7 with 36 Sends.



Once you have adjusted the auxes in this display, you need to close it manually before opening any other channel detail display.

**Note that further worksurface assignments of auxes is available via the Surface, Faders and Solo tabs of the Options menu.**

# Chapter 1 - Channel Types

## 1.4.7 Group Outputs .....

Group outputs are routed from within the **groups** section of the channel **Outputs** display. Touching the **mono** button to the left of the display produces a list of available mono groups in the right of the display, and touching the **stereo** or surround format buttons produces a list of the other types of group. These buttons 'light' to indicate that it is their group outputs list which is currently displayed, and 'half-light' to indicate that there is routing to busses of that format which isn't shown in the display. Touching any of the groups within each list routes the channel to that group. Each channel can be routed to as many mono and stereo groups as have been created.

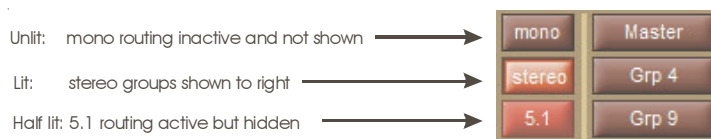

Any mono groups being fed by a stereo channel will receive a L+R summed signal of the channel output.

The lowest selected group output is displayed in the channel strip, below the left side of the channel name, and the currently selected direct output is displayed below the right side of the channel name.

When a new session is created, the lowest numbered stereo group is always designated the **Master**. Therefore, all input channels are routed to it by default, and the master fader(s) are assigned to it.

## 1.4.8 Direct Outputs .....

Basic routing is described in your console's Getting Started section. Once the direct output has been routed, it is switched on by pressing the grey **on** button next to the output level meter in the grey area below the **direct outs** routing button. The direct out is taken post-fader by default, but can be switched to pre-fader or pre mute by pressing the button to the right of the **on** button. The current selection is displayed to the right of the button.



## 1.5 Output Channels Specific Functions

### 1.5.1 Unfolding Channels .....

Group and Aux Channels which are stereo or surround have an **Unfold** button above their meters, which is used to display the components of the signal in their own channel strip with a master channel displayed to their left.

In the top section of the unfolded Master channel, buttons for each component channel allow you to define which channel's elements are displayed in the Folded View.

In the middle area of the unfolded Master channel, the links between component channels can be edited. Links function in the same way as Gangs, but are limited to the components of a multi-channel signals. To edit links, press the **Set Links** button so that it goes red, then press the **LINK** buttons above the channel meters in the channels to be linked or unlinked - each button will take on the same colour, indicating that they are linked. To remove a link, press the **LINK** button while **Set Links** is active. Note that if you start a set of links and then de-link and re-link another channel, a new link set will be started, as indicated by the introduction of a new link colour. When you have finished linking channels, deselect **Set Links**. You can also **clear all links** and **link all** using the buttons below **Set Links**.

**Note that if component channels have different settings when linked, changes in hidden, linked channels will be made relative to the change in the Folded View channel, but the display will only reflect the Folded View channel.**

Below the link buttons in the master, there are buttons for each element in the components' channels - **trim & delay, filters & eq, dynamics** and **faders & mutes**. Pressing one of these buttons will cause that element in all the channels to match those of the Folded channel.

Once you have finished with the unfolded view, press the **FOLD** button to fold the channels back together. The picture below shows a 5.1 Buss from an SD5/SD7

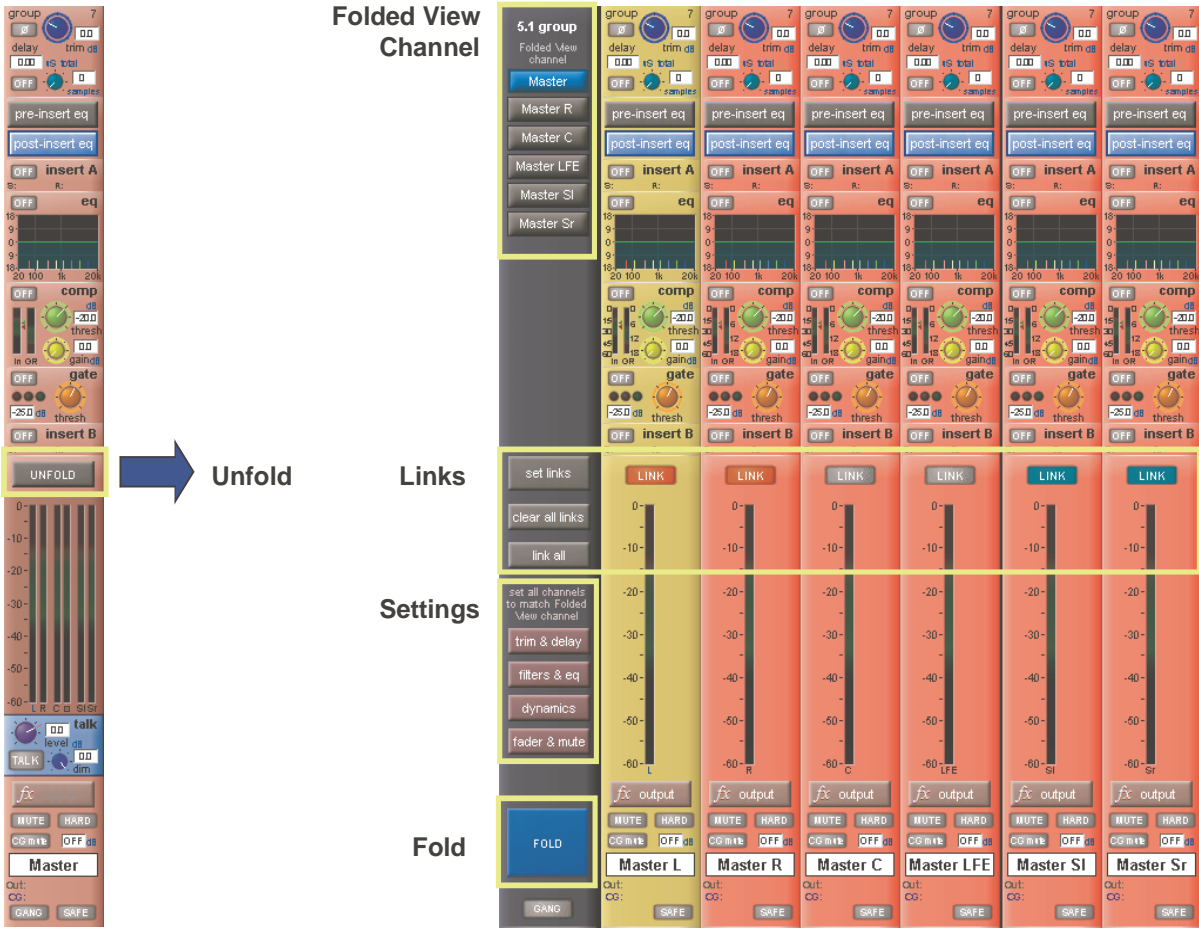

1.5.2 Group Channels Specific Functions .....

The Group channel input signals are defined within the Input channels **Output** display. The top section of the Group channel **Setup** display lists all of the currently selected **inputs** to that group. The inputs list can be scrolled using the scroll bar to the right if necessary. Below the list there are two buttons: **clear all** removes all of the input routes to that group. Pressing this button produces a confirmation box in which the clear all can be confirmed or cancelled. **connect all** routes all Input channels to the group.

*Note: With either the connect or clear all functions, you can exclude individual channels from the function by touching their faders when the button is pressed.*

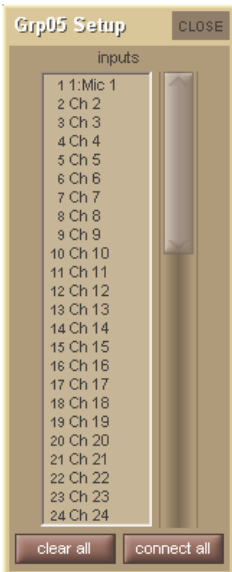

Group channel output routing functions are very much like Input channel output routing.

# Chapter 1 - Channel Types

## Aux Sends on Groups

Group output Busses can send audio to Aux output busses. Pressing the Aux send button, located above the output meter, will open the expanded aux panel and the sends will be assigned to the under screen rotaries.

To access the aux sends for a stereo, LCR, LCRS or 5.1 Group, the Buss must be unfolded to show the individual legs, each leg having it's own aux send levels.

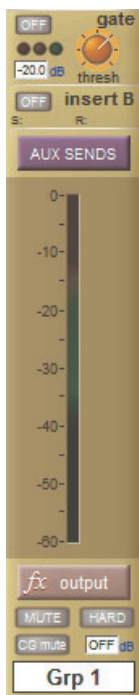

### 1.5.3 Aux Channels Specific Functions .....

As the Aux channel input signals are defined within the Input channels, there is no input selection available within the Aux channel Setup display. There are, however, a number of configuration options in the top half of the Setup display:



The **set all sends** buttons at the top of the **Setup** display affect the sends to that aux bus from all of the Input channels.

The three buttons on the left, **pre mute**, **pre fader** and **post fader**, set the point in the channel from which the aux send is taken. The current send point is displayed next to the aux send level in the Input channels.

*Note that send points can also be individually selected within the Input channel using the 2nd function button.*

Pressing the **link pans** button, located to the right of the **pre mute** button, links that aux send pan to the main channel pan in the Input channels. This button lights red to indicate that it is active. Further indication is provided by the aux pan slider in the Input channel strip being lit pink. **Rev link pans** inverts the link between the channel pan and aux send pan.

Pressing **aux to fader** assigns control of all input channel's auxiliary sends to the channel faders.

Pressing **aux to rotary** assigns control of all input channel's auxiliary sends to the top available encoder row beneath the Channel Strip panel.

The purple **copy levels from** buttons also affect the sends to that aux bus from all of the Input channels. The buttons list can be scrolled using the scroll bar on the right. These buttons are used for universally setting the aux send levels:

**Off** sets the level to off and **0dB** to 0db. **fader** sets each Input channel's aux send level to match the level of its channel fader. The remaining **copy levels from** buttons copy a different set of Input channel aux send levels to that aux send.

*Note that when a copy levels from button has been pressed, send levels can still be individually readjusted within the Input channel.*

Touching the **mix presets** button (below the **copy mix levels from** list) opens the **Aux Mix Presets** display, where you can store and recall presets of an aux send's parameters for all input channels, using the standard presets procedure, detailed in Section 2.

## 1.5.4 Matrix Channels Specific Functions .....

As the Matrix channel input signals are defined within the **Matrix** inputs display, there is no input selection available within the Matrix channel.

## 1.6 Channel Signal Processing

Each channel type contains similar signal processing functions, including EQ and dynamics. Input channels also have high-pass and low-pass filters. Pressing on each of these areas of the channel strip will open the relevant signal-processing display.

### 1.6.1 Channel Filters .....

**(All SD input channels and on SD8,9,11 output channels)**

The filters section of the channel-strip is located below the input section of each input channel. It consists of two frequency pots, each with its own on/off button and a display of the filter's cutoff frequency (the -3dB value) in Hertz. The on/off buttons are grey to indicate that the frequency band is off, and red to indicate that it is on. The low-pass filter is at the top and the high-pass filter is at the bottom, and both have a roll-off of 24dB per octave. The filters directly follow the input section in the signal chain.

The filters area is replicated at the top of the EQ/filters display, accessed by touching the EQ area of the channel strip. The filter can be configured using the dedicated filter encoders and buttons at the top of the channel worksurface controls:



A graphic representation of the filters is included in the EQ graph located below **Insert A** in the channel strip, described below. The red line in the graph represents the current filter settings.

*Note that the filters section of the input channel strip may be hidden behind channel meters. In this case, moving the filter encoders will cause them to be displayed momentarily. To hide the meters and retain a permanent display of the filter controls, press the assign down button, located to the left of the encoders above the screen.*

### 1.6.2 Input Channel EQ .....

The SD input channel EQ has four bands, each of which can be made dynamic. The four EQ bands are colour coded: Blue for HF, green for HMF, yellow for LMF and red for LF. The in-channel display is located below **Insert A** and consists of a graphic representation of the current EQ and an on/off button. The button is grey to indicate that the EQ is off, and red to indicate that it is on. The green line in the graph represents the frequency response of the EQ, and the red line represents the response of the filters – each line goes bright to indicate that it is on. The extent and brightness of the clouded area in the bottom half of the graph also indicates which elements are on. The central frequency of each band is displayed by small lines in the band colours, along the bottom of the graph.

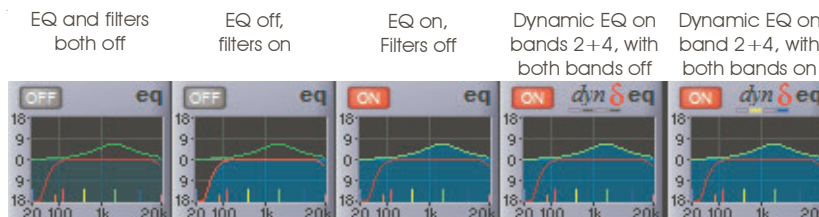



# Chapter 1 - Channel Types

Touching the EQ area of the channel strip brings up the EQ/filters display. The EQ section of the display is below the filters section, and has another graphic representation of the current EQ at the top. Touching this EQ graph will open an expanded view of the graph. The EQ can be configured using the dedicated encoders and buttons on the worksurface which follow the same layout as the display:



In both the EQ/filters display and on the worksurface, each band has a  $\pm 18$ dB **gain** controller on the left, a **frequency** controller (ranging from 20Hz to 20kHz) top right and a **Q** control bottom right. Each pot has its value displayed to its right.

Bands can be switched between a **bell** curve (which is the default setting) and a **Hi/lowshelf** using the **bell** button.

On SD5/SD7, the **bell** button's **2nd function** allows the each band to be switched between **prec** (precision, where the Q is narrower on the cut curve than the boost curve) and **class** (classic, where the cut and boost Q curves are identical in width). The active setting is shown in red to the right of the **bell** button. Pressing the **precision** or **classic** buttons above the EQ controls will switch all four visible bands to that shape. The active button goes blue – if different bands are employing different shapes, neither button will be lit.

The EQ is switched on using the **eq on** button between the HMF and LMF controls which rings red to indicate that it is on.

**Note that when a band is in dynamic mode, it can also be switched on and off individually in the dynamic display. See below.**

Towards the bottom of the EQ/filters display are four grey buttons marked **safe**, **flat**, **preset** and **copy to**. Touching **safe** adds the EQ to that channel's list of channel safes. Touching **flat** resets the EQ gain controls to 0dB. Touching **preset** brings up the **Presets** display which can be used to save and recall presets. Touching **copy to** will open the copy to panel with the EQ section Pre Selected.

Below these buttons is a smaller round button which is also found at the bottom of the channel worksurface controls, for switching the signal-processing order. The default setting is EQ followed by dynamics, as indicated by the **eq-dyn** label being to the left of the button. Pressing this button reverses the order, as indicated by the labelling switching to an **dyn-eq** display to the right of the button.

## Dynamic EQ

In a dynamic EQ module, the EQ adjustment is applied dynamically, based on the level of the incoming frequency relative to a predetermined threshold. Dynamic EQ is accessed by touching the red "Delta" symbol on any EQ band. Activate the dynamic function by pressing the **dynamic on** button (a red ring will appear in the button). When dynamic EQ is active, you can also mute and unmute the entire EQ band by pressing the **band on** button (a red ring indicates that the band is unmuted).

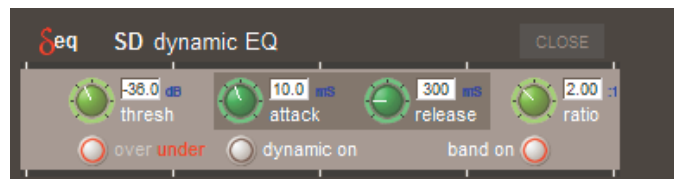

When any dynamic EQ bands are on, a dynamic EQ icon appears above the EQ graph in the channel strip (as shown on the previous page). The four boxes beneath the icon indicate the status of each band – each box is empty (light grey) when the band dynamics are off, dark grey when the dynamics are on but the band is off, and coloured when the dynamics and band are on.

DiGiCo dynamic EQ can operate in two modes: 'over' or 'under':

### Over Mode

To place the dynamic module into Over mode, ensure that the Over indication below the threshold control is not illuminated.

When the signal entering the module passes the threshold, the EQ adjustment (as determined by the frequency and Q controls) starts to be applied, up to a maximum adjustment, determined by the EQ band gain control. The manner in which the EQ adjustment is applied once the threshold has been reached is determined by the attack, release and ratio controls.

<b>Gain :</b>	Sets the maximum EQ adjustment that could be applied
<b>Frequency / Q / Curve :</b>	Adjusts the EQ characteristics
<b>Threshold :</b>	Sets the threshold at which the EQ starts to be applied
<b>Attack :</b>	controls how quickly the dynamic module responds to level passing the threshold
<b>Release :</b>	adjusts how quickly the module responds to a fall in level
<b>Ratio :</b>	controls how quickly the maximum adjustment is reached once the threshold level is passed.

Over Mode is generally used with a reduction in gain at a specific frequency, such that when the threshold is reached, a gradual reduction of level at that frequency is applied. This could be used to control a change in tonal characteristics as a singer pushes their voice to sing louder.

### Under Mode

To place the dynamic module into Under mode, ensure that the Over indication below the threshold control is illuminated.

In under mode, the maximum EQ adjustment (as determined by the frequency, Q and band gain controls) is applied when the signal entering the module is below the threshold. As the signal level approaches the threshold, the EQ adjustment is reduced to the point where there is no EQ being applied at the threshold. The manner in which the EQ adjustment is reduced as the signal level approaches the threshold is determined by the attack, release and ratio controls.

# Chapter 1 - Channel Types

## 1.6.3 Output Channel EQ .....

The EQ located in each output Channel is similar in operation to the input channel EQ, with the following exceptions:

Output channel EQs have either have 4 Bands of EQ and HPF/LPF (SD8,9,11) or eight bands – four pre-insert and four post-insert (SD5,7,10). Buttons in the channel strip (**pre-insert eq** and **post-insert eq**) and in the EQ display (**pre-insert bands** and **post-insert bands**) select which set of bands is assigned to the worksurface and display controls. All eight bands are shown in the EQ graph, with the pre-insert bands shown in lighter shades than the post-insert bands.

The **precision** and **classic** buttons above the EQ bands only affect the four bands currently displayed, and not the full 8 bands available. The pre-insert bands do not have dynamic EQ or bell-shelf switching – the bell button is only used for switching between precision and classic Q shapes. (SD5,7,10)



## 1.6.4 Channel Dynamics .....

The SD channel dynamics includes two dynamics modules. Module 1 is a fully configurable compressor which can be split into three frequency bands or configured as a de-esser; Module 2 can function as a gate, a ducker, or a compressor, all with high- and low-pass filtering on the key input.

The in-channel display is located below the **eq** display, with Module 2's controls shown below Module 1's. Each module can be switched on by pressing the on/off switch in the upper left corner of its channel area. These buttons are grey when off and red when on.

The display includes an input (**In**) meter and a gain reduction (**GR**) meter. The input meter has arrows to its right which display the current threshold values for each module. Each arrow is distinguished by its colour, which matches its associated threshold pot.

When Module 1 is in Compressor or Multiband mode, **threshold** and **gain** pots, each with a value display in dB, are also shown in the channel strip (when in Multiband mode, the threshold pot affects all bands and the mid band's value is displayed). The De-esser only displays a threshold pot and its value. There is a threshold pot (with value display) shown for Module 2, with three status indication lights shown when in Gate or Ducker mode.



1: Compressor      1: Multiband      1: De-esser  
 2: Gate            2: Ducker         2: Compressor

Pressing anywhere in either module area brings up the expanded **dynamics** display.

To switch each module between its three modes, touch the button on the left of its expanded display, marked **comp/multi/desser** for Module 1, and **gate/duck/comp** for Module 2. Both modules can be switched on using the **on** button below their

**threshold** buttons. The joint input meter is shown in the expanded display, with the same threshold indication. In multiband channels, each component has its own meter.

The pots within the expanded display are automatically assigned to the worksurface encoders below the screen when the dynamics panel is expanded, as indicated by the matching coloured rings around the pots and encoders. When in Multiband mode, each band is assigned to a row of encoders. When Module 2 is also on, it appears in the bottom row of encoders.

**Note that if the gate occupies the bottom row of encoders while the multiband compressor is on, the HF compressor band is not displayed, and the MF and LF bands both shift up a row.**

At the top of the expanded display are buttons marked **safe**, **presets** and **copy to**. Touching **safe** adds the dynamics to that channel's list of channel safes. Touching **preset** brings up the **Presets** display which can be used to save and recall presets. Touching **copy to** will open the copy to panel with the dynamics section pre selected.

If a **link** button is shown below the input meter, it allows two channels to be linked together. In other words, the other channel's signal is added to this compressor's control circuit input, and this channel's signal is added to the other channel's control input. On stereo input channels, the link is always active and the button isn't shown. On stereo output channels, the **link** button is available and the link is always between left and right components; it is active by default.

On mono or multiband channels, pressing this button brings up a dynamics link display listing **Channels**, **Groups** and **Auxes signal groups** in the left-hand side. When one of these **signal groups** is selected, their available **signals** are listed in the right-hand side of the display. Select a signal to link to and close the display.

The **link** button is ringed red and the linked channel's number and name is displayed in the box above it to indicate that there is a link present. To cancel the link, press the button again and deselect the link signal.

**Note that when a link channel has no name, the display repeats the channel number.**

Beyond the link function, the different modes of each module have completely separate settings: No settings are copied between them. If you switch from one mode to the other, the settings will be reset to their defaults. The controls specific to each mode of each module are described below:

### Module 1: Compressor



In Module 1's compressor, **threshold**, **attack**, **release**, **ratio** and **gain** controls are provided, each of which function in the normal way. The compressor has an auto gain function which is switched on by pressing the **auto gain** button below the **ratio** pot. This function automatically adjusts the gain makeup when changes are made to the **threshold**, thus keeping the compressor output steady. The threshold knee can be switched between **hard**, **mid** and **soft** using the **knee** button in the right side of the module. The gain reduction (GR) meter is duplicated in this display.

### Module 1: Multiband Compressor

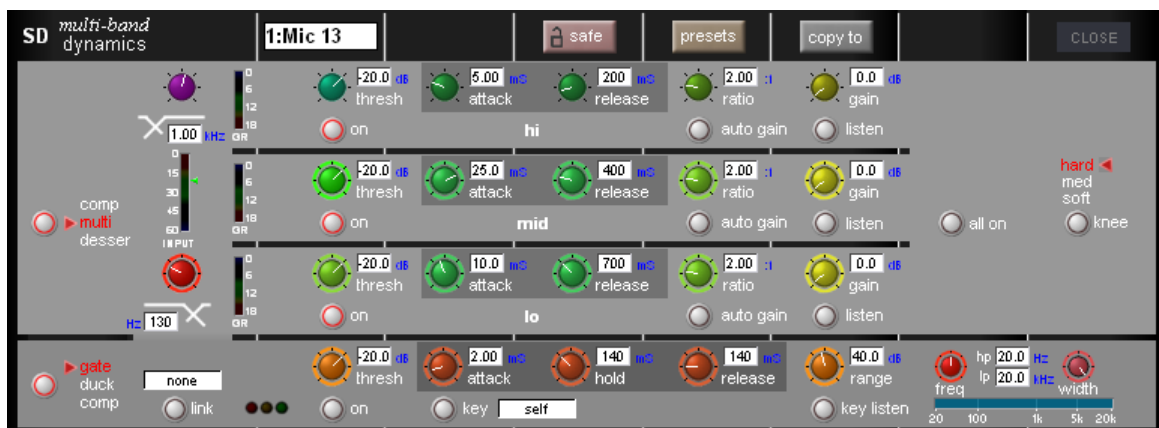

In Module 1's multiband compressor, each band includes all of the parameters found in the single band compressor. The link function remains available for the whole compressor, and is not assigned to any band. The bands can be switched on individually using the **on** buttons in the left-hand side of each band, or together using the **all on** button in the display's right.

The crossover frequency between bands is controlled using the purple and red pots to the left of the **hi** and **lo** bands. Each crossover has a range of 20Hz to 20kHz, and the crossover frequencies are displayed below each pot. Each band can be auditioned by pressing the **listen** button below each **gain** pot.

**Important Note: In software versions earlier than V463, when any band is switched off, that band will not pass audio. In later software versions, bands which are off are bypassed rather than muted.**

# Chapter 1 - Channel Types

## Module 1: De-esser



The de-esser's controls are similar to those of the compressor, with the following exceptions: In the right side of the module, there is a band-pass filter control for the de-esser sidechain, with pots provided for the centre frequency and filter width. The -3dB points for the hi-pass (**hp**) and lo-pass (**lp**) frequencies are shown. The filtered sidechain can be auditioned by pressing the **listen** button. Note that there is no makeup gain included.

## Module 2: Gate



Gates can be keyed by a different signal by pressing the **key** button below the **attack** pot. This brings up a **Gate Key Route** display from which a key input can be selected. Consecutive channel gates can be keyed by consecutive input signals using the **ripple channels** function. The key button is ringed red and displays the key input in the text box to its right to indicate that another signal is keying the gate. The key input signal can be auditioned by pressing the **key listen** button underneath the **range** pot.

There is a band-pass filter available: the **width** control adjusts the width of the band being passed, and the **freq** control moves that band through the frequency range. The hi- and lo-pass sidechain filter frequencies are displayed. To the right of the **link** button, there are red, amber and green status indication 'traffic lights'.

## Module 2: Ducker



The ducker has exactly the same controls as the gate, though the sidechain performs the opposite function of ducking the signal rather than gating it.

## Module 2: Compressor



Module 2's compressor is identical to the single band mode of Module 1, with the addition of the band-pass filter described above, and a sidechain input function (**S/C**) which functions exactly like the **key** function of the gate.

## 1.7 LCD Functions

### 1.7.1 Introduction to LCD Functions .....

The LCD button/display is located above the channel fader, and is included in every channel in both the centre section and side sections of the consoles. The channel number is displayed in the top half and the current function mode of the button is displayed in the bottom half of the display and is also indicated by its colour.



LCD buttons (SD5,7) or Select Buttons (SD8,9,10,11) are able to fulfil a number of different functions, and are even involved in selecting their own function. These functions are accessed by pressing the **lcd function** button, located above the **bank** buttons on each section of the desk. When this button is pressed, LCD displays for the channels associated with it turn yellow, indicating that they have become function mode selectors:



Selecting one of these options assigns that function mode to the LCD/select buttons for all the channels within the **banks** associated with that **lcd function** button.



There are twelve different function mode options.

**1.7.2 Solo** .....

When an **lcd function** button is pressed, the left-hand LCD display is labelled **SOLO**. When **SOLO** mode is selected, the LCD/select buttons become solo buttons. The bottom half of the LCD display indicates which solo busses are available to the channel, as defined in the channel **Setup** display and the **SOLO CHOICE** function mode (described below). The display also shows whether each buss is AFL or PFL, as defined in the top-left corner of the master solo display.

In **SOLO** mode, the LCD displays are coloured according to their channel type when not soloed, and coloured green when soloed.

*Note that this is the default mode of the LCD/select buttons, current when no other function modes have been selected.*

**1.7.3 Solo Choice** .....

When an **lcd function** button is pressed, the second LCD display from the left is labelled **SOLO CHOICE**. When this mode is selected, the LCD/select buttons are used to select the solo bus assignment for that channel, toggling between **1**, **2** and **1+2**.

In **SOLO CHOICE** mode, the LCD displays are coloured cyan.

**1.7.4 GANG** .....

When an **lcd function** button is pressed, the third LCD display from the left is labelled **GANG**. When this mode is selected, the LCD/select buttons are used for linking together all channel controls. All LCD/select buttons which are then pressed will have their controls linked. In the case of currently ganged channels, the LCD/select button can be used to remove them from their ganging group. The colour of the **GANG** symbols in the bottom left-hand corner of the on-screen channel display indicate what ganging groups exist: All faders which are ganged together will share one colour. Each time the **GANG lcd function** is selected, a new ganging group is started, as indicated by the **GANG** symbols turning a different colour.

To gang channels across different surfaces of the console, activate the **GANG** LCD function on each surface before starting to build the gang. A single cross-surface gang can then be created using the LCD/select buttons in the usual way.

To stop adding channels to the current gang and start a new gang, simply reselect the **GANG** LCD function.

When channels are ganged together, operating any of their channel controls will cause all other channels within the ganging group to replicate that movement. Pan and phase controls are not included in gangs.

*Note that it is the level change associated with the fader movement which is replicated, not the physical distance the fader is moved.*

*Note also that when a ganged channel is muted, those channels within the ganging group which were already muted will stay muted. When the channel is then unmuted, all channels unmute, irrespective of whether they had been initially muted.*

*Note also that when any member of a gang is Assigned, the Undo function will always take the faders back to their position when the channel Assignment was made.*

Channels can be temporarily isolated from Gangs by pressing the Option button.

*Note that gangs cannot be edited once they have been created.*

# Chapter 1 - Channel Types

## 1.7.5 JOIN CG .....

When an **lcd function** button is pressed, the fourth LCD display from the left is labelled **JOIN CG**. When this mode is selected, the LCD/select buttons can be used for assigning channels to Control Groups. Control Groups enable a number of channel output levels and mute functions to be controlled from one master fader. Control Groups can include any combination of channels from all four channel types. For more detailed information on Control Groups, please refer to the Master Section of this Manual.

## 1.7.6 Assign Faders .....

To assign channels to the worksurface, enter **ASSIGNFADERS** mode. The LCD displays will turn dark green and their lower halves will read **ASSIGN**. Press the LCD/select buttons for each of the channel strips to which you wish to assign new channels.

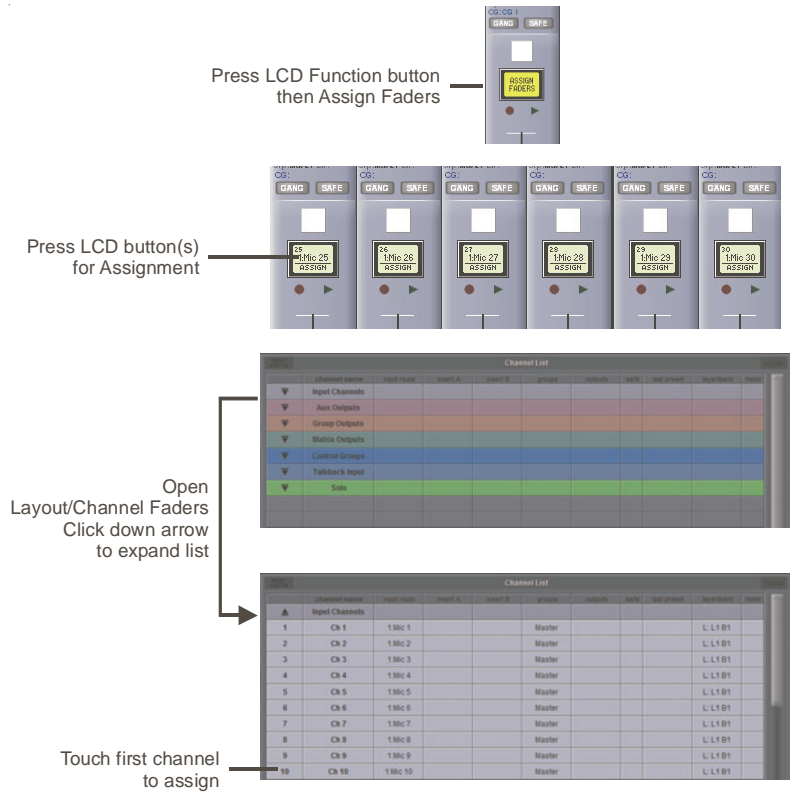

To select the channels you wish to assign to those channel strips, open up the **Channel List** display, accessed by going to the master screen and touching **Layout > Channel List**. There you will find a list of all input, output and control channels that are present in the session structure, grouped by channel type. Open up the channel list for the channel type of the first channel to be assigned by touching the appropriate down arrow in the left-hand column. The channel list can be scrolled using the scroll bar on the right of the display:

To assign one of the listed channels to the channel strip, simply touch the channel name in the list. The remaining channels can now be assigned in the same way, The channels selected in the **Channel List** display are assigned to the selected channel strips in ascending order, starting with the lowest channel in the bank.

**Note that the assign function is restricted to the currently selected bank.**

**Note also that when new channels are added to a session, or when a session is created, all of the existing channels can be assigned to the worksurface using the rebuild banks function within the Session Structure display.**

## 1.7.7 Unassign Faders .....

To remove channel assignments from a channel strip, enter **UNASSIGNFADERS** mode. The LCD displays will turn dark green and their lower halves will read **UNASSIGN**. Press the LCD/select button for any channel strip you wish to clear, and the strip will go blank.

## 1.7.8 Swap Faders (SD5/SD7) .....

To swap the positions of two channels, enter **SWAP FADERS** mode. The LCD buttons will turn dark green and their lower halves will read **SWAP**. Press the LCD button for the two channels you wish to swap, and they will swap places.

## 1.7.9 Move Faders (SD5/SD7) .....

To move channels within a channel strip, enter **MOVEFADERS** mode. The LCD buttons will turn dark green and their lower halves will read **MOVE>>**. Pressing any LCD button will result in that channel moving one space to the right. If the bank is full all channels to the right of the moved channel will move right, and any channel which had been occupying channel-strip 12 will be lost from the layout. If there is a blank channel strip anywhere to the right of the moved channel, any channels further right than the blank will not move, and the moved channels will simply fill the blank space.

For example, if the bank is occupied by input channels 1 to 12, pressing **MOVE>>** on channel 6 will result in channels 6 to 11 moving one space to the right, leaving a space in channel strip 6, and channel 12 being removed from the layout. Pressing **MOVE>>** on channel 4 will then result in channels 4 and 5 moving one space to the right, filling the space that was in channel strip 6 and leaving a space in channel strip 4.

When blank channels are moved they simply swap positions with the channel to their right. Note that any blank channels immediately to the right of the one being moved will move as well, and the blanks will move by as many channel strips as there are blank spaces being moved.

For example, if channel strips 1 to 3 are blank and Input channels 1 to 9 are occupying strips 4 to 12, pressing **MOVE>>** on channel strip 2 will result in blanks 2 and 3 swapping places with Input channels 1 and 2.

## 1.7.10 Copy Bank From .....

To copy a different bank of channels to the current bank location, press **COPYBNKFROM**. The message 'PRESS | A BANK | BUTTON | FOR | COPYIN | FROM' will be shown across the LCD displays. Simply press the **bank** button for the bank which you want to copy to the current location.

## 1.7.11 Copy Bank To .....

To copy the current bank to different bank location, press **COPYBNKTO**. The message 'PRESS | A BANK | BUTTON | FOR | COPYIN | TO' will be shown across the LCD displays. Simply press the **bank** button for the bank to which you want to copy.

## 1.7.12 Clear Bank .....

To clear all channels from a bank, press **CLEARBANK**. The message 'CONFIR| CLEAR| BANK:| YES| NO' will be shown across the LCD displays. Press **NO** to cancel the action or **YES** to continue.

*Note - Banks can be moved between layers, and also between sections of the console.*

*Note also that the Fader Banks display on the master screen can also be used for altering the bank layout.*

*Note also that there is no undo function for these actions. Proceed with care!*

## 1.7.13 Create Multi .....

The final LCD function, **CREATE MULTI**, is used to place new Multi channels onto the surface. When active, the LCD function buttons of any assigned faders will remain in their **SOLO** mode, whereas all unassigned faders will be available for creating new Multis. Once created, Multis can be configured in the normal way, as described below.

## 1.8 Multi Channels

If you are working in Surround, or using another multi-channel format, you can create LCR, LCRS and 5.1 busses in the Session Structure window described in Section 1.5.1.

Multi-channel inputs are controlled by routing each component through a mono channel and then linking those channels via a 'Multi' channel. To start with, use the normal input and output routing procedures to route each component through a channel. There are then two options for creating a Multi channel: If you want to create the Multi in place of the channel strip for its first component, open the **Setup** display for the first component and select **Multi** at the top. Alternatively, if you want to create a Multi in a previously unassigned location, use the **CREATE MULTI** LCD function described above.

Whichever procedure you use to create the Multi and assign it to a fader, you will now be presented with a **Setup Multi Channels** display. Select the format – **LCR**, **LCRS**, **5.1** or **multi-input** (which allows you up to 11 components) – and then press the LCD buttons for the remaining component channels, working down the displayed list in order. Channel names will appear against each component. Channels can then be left on the worksurface or removed using the buttons towards the base of the display. Finally, touch **OK** to close the display to link the channels together.

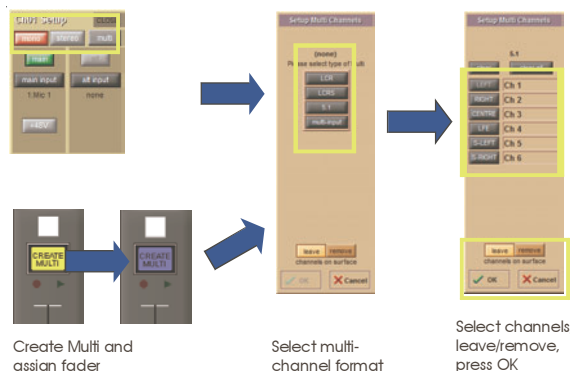



# Chapter 1 - Channel Types

Multis can be unfolded in order to access controls for each component. This is done by pressing the **Unfold** button in the channel strip. When unfolded, the normal channel assignments are hidden, each component is given its own channel strip, and a Multi master channel is displayed to their left (shown over the page).

**Note that if leave (channels on the surface) was selected when the Multi was created, the component channel strips are available whether or not the Multi is folded.**

In the top section of the unfolded Master channel, buttons for each component channel allow you to define which channel's elements are displayed in the Folded View, if any **Folded Controls** are activated (see below).

In the middle area of the unfolded Master channel, the links between component channels can be edited. Links function in the same way as Gangs, but are limited to the components of a multi-channel signal. To create or edit links, press the **Set Links** button so that it goes red, then press the **LINK** buttons below the channel names in the channels to be linked - each button will take on the same colour, indicating that they are linked. To remove a link, press the **LINK** button while **Set Links** is active. Note that if you start a set of links and then de-link and re-link another channel, a new link set will be started, as indicated by the introduction of a new link colour. When you have finished linking channels, deselect **Set Links**. You can also **clear all links** and **link all** using the buttons below **Set Links**.

Below the link buttons in the unfolded Multi Master, there are buttons for each element in the components' channels - **trim & delay, filters & eq, dynamics** and **faders & mutes**. Pressing one of these buttons will cause that element in all the channels to match those of the Folded channel.

Once you have finished with the unfolded view, press the **FOLD** button to fold the channels back together.

In folded view, the channels included in the Multi are shown in the middle of the Multi channel strip. Touching the **Folded Control** button brings up four buttons which allow you to define which channel elements are displayed in the folded channel strip: **Input, EQ, Dynamics** and **Aux Sends**. These settings reflect the channel which has been set as the Folded View channel; the Folded View Channel is shown with a blue (as opposed to black) channel number in the list displayed in the folded channel, if any Folded Controls are activated. Adjusting any element in the Folded channel strip will affect all linked channels.

**Note, however, that if channels have different settings when linked, changes in hidden, linked channels will be made relative to the change in the Folded View channel, but the display will only reflect the Folded View channel.**

**Note also that activating the Aux Sends Folded Controls will result in the channel components list becoming hidden.**

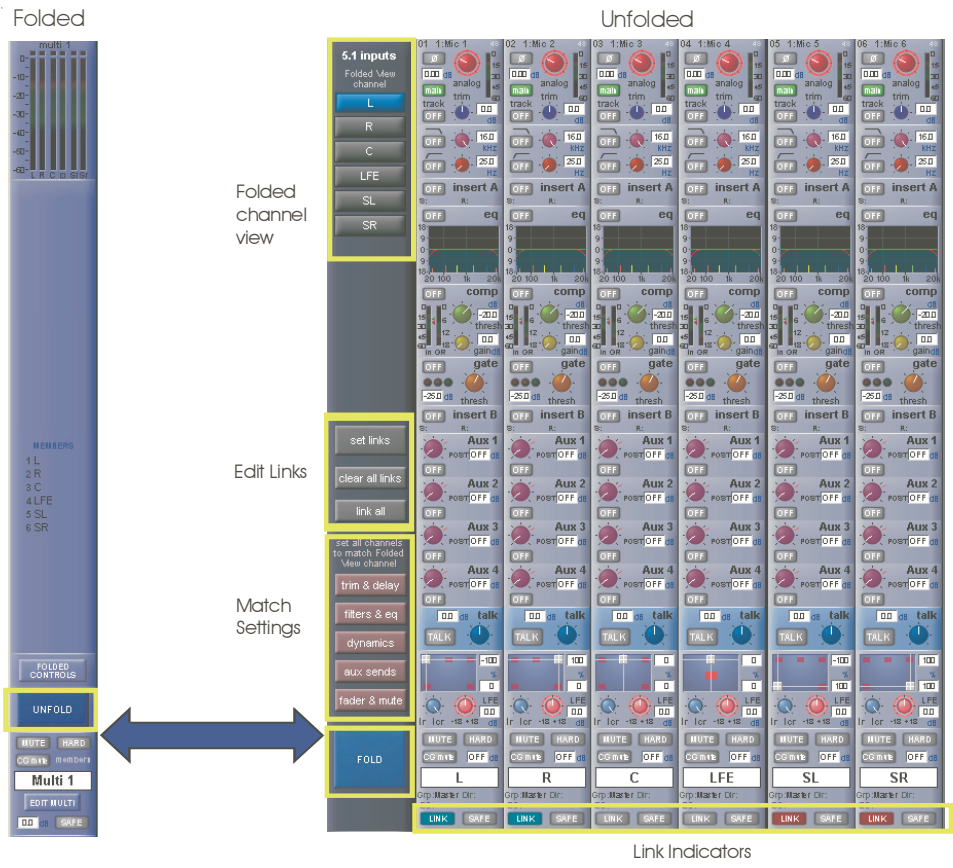

The fader and mute on the Multi channel strip will always affect all of the Multi members irrespective of the link settings and thus serves as a “Master” fader and mute for that multi’s members.

The on screen indicators for **Channel Mute**, **Hard Mute** and **CG Mute** at the bottom of the Multi strip give an indication as to whether any of the Multi members are Channel Muted, Hard Muted or CG Muted. If any member has any one of these types of mute active, the Folded Multi’s indicator will show this.

In the Folded Multi view the worksurface Mute switch can have one of three different states:

- 1) Not lit (OFF) - the Multi Master Mute is not active - unmuted. Note that if any channels are muted individually, the **mute** indicator below the **unfold** button will be red.
- 2) Lit and red (ON) - the Multi Master Mute is active - muted.
- 3) Flashing from OFF to ON - the Multi Master Mute is active but at least one of the members has been unmuted (opened) thus overriding the Multi Master Mute on one or more of the Multi’s Members.

### Edit Multi

At the bottom of the Multi strip there is also an **Edit Multi** button which allows the members of the Multi to be changed or the Multi to be cleared or deleted. Pressing this button will open the **Setup Multi Channels** panel.

To edit the members of the Multi, press one of the grey buttons on the left to select a member and then press one of the worksurface Channel Select buttons to assign a channel. To clear the Multi, press the **Clear All** button at the top of the panel and then either select a new type of Multi or delete the Multi completely by pressing the **Delete Multi** button at the bottom of the panel.

# **SD Series Software Reference**

## **Chapter 2:**

### **The Master Screen**

# Chapter 2 - The Master Screen

This chapter describes all of the functions accessed from the Master Screen. The chapter focuses on the functions of the menu buttons across the top of the Master Panel, working through the buttons from left to right. Master Section worksurface elements are described within the context of the Master Panel display.

To open the Master screen press the worksurface **Master** button in the centre section (SD8, SD10, SD9, SD11).

## 2.1 System Menu

### 2.1.1 Diagnostics .....

The **Diagnostics** display is explained in the Troubleshooting chapter.

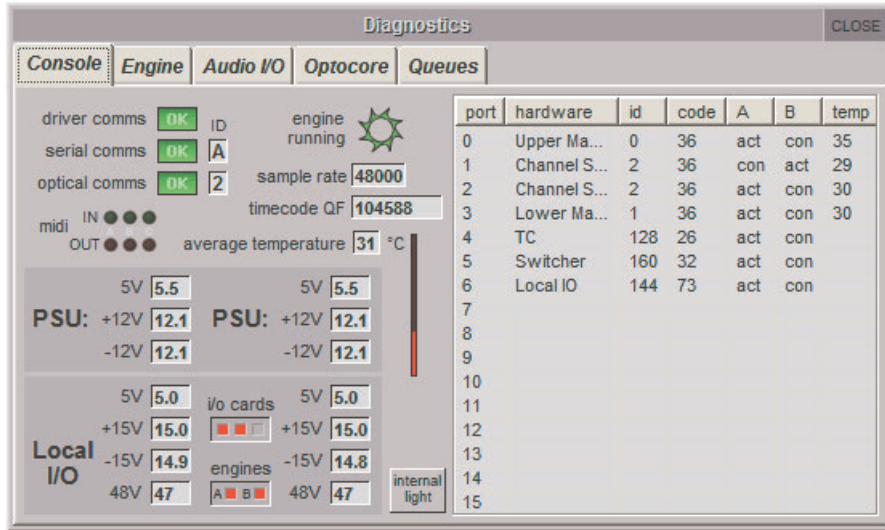

### 2.1.2 Oscillator .....

The oscillator is configured in the **Oscillator** display.

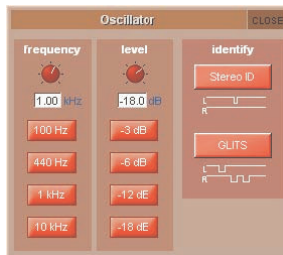

The frequency of the oscillator is controlled by the left-hand **frequency** pot, and its audio level is controlled by the right-hand **level** pot. The buttons below each pot, can be used to set the oscillator to standard frequencies (100Hz, 440Hz, 1kHz, 10kHz) and levels (-3dB, -6dB, -12dB, -18dB). The current value of each parameter is displayed below its pot.

For Stereo channels, the 1 KHz oscillator can be set to produce a pulsing ID signal on the left signal or a GLITS signal as indicated by the on-screen graphic.

### 2.1.3 GPIO Relays .....

Selecting **GPIO Relays** opens a panel displaying the current GPI and GPO states. The panel will show the GPIO configuration for your console. The numbered 'out:' buttons allow GPOs to be triggered. If the **toggle** button above them is active (lighter), then touching a GPO button will switch it on (red) or off (brown). If the **pulse** button is active, touching a GPO button will send an 'on' pulse.

**Note that GPOs which are on when entering pulse mode will stay on. Touching them while in pulse mode will switch them off.**

The **GPI event** light in the top right-hand corner indicates when GPI messages arrive. Below the GPO buttons is a row of indicators (labelled 'in:') showing the current state of each GPI.



**2.1.4 Security** .....

Security modes are selected in the system menu, with a choice of three levels of access:

- Setup:** Users have full access to every function on the console.
- Live:** Access to elements of the console can be limited, and password protected.
- Unattended:** The console is locked, and cannot be operated.

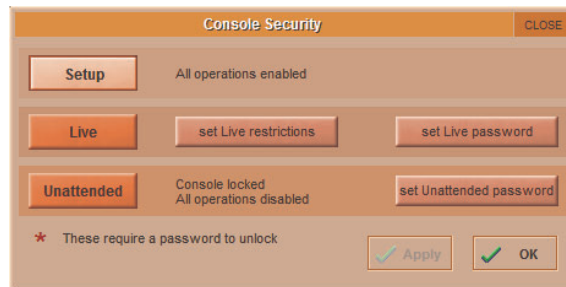

User passwords can be defined for the Live and Unattended modes. To set a password, press the **Set Password** button. Enter the old password then the new one twice, and press **OK**. By default, the passwords are blank.



**NOTE:** If you should forget your password, call your Distributor to obtain a reset password. Entering the master override password will allow new passwords to be set.

To modify restrictions in Live mode, press the **Set Live Restrictions** button in the **Console Security** Panel. A range of parameters are shown, with a tick indicating that access is allowed and a cross that the item will be locked out in Live mode. Each group list can be expanded for item-specific restrictions by pressing on the down arrow in the left-hand column, as shown for **FX** below:

Live Security Restrictions														CLOSE
	channel name	input/trim	delay	filters	eq	dynamics	inserts	sends	fader	mute	panner	to groups	outputs	
▼	Local I/O	✓												
▼	Rack 1	✓												
▼	Rack 2	✓												
▼	Rack 3	✓												
▼	Con	✓												
▼	Input Channels	✓	✓	✓	✓	✓	✓	✓	✓	✓	✓	✓	✓	
▼	Aux Outputs	✓	✓		✓	✓	✓		✓	✓			✓	
▼	Group Outputs	✓	✓		✓	✓	✓		✓	✓		✓	✓	
▼	Matrix Inputs	✓						✓						
▼	Matrix Outputs	✓	✓		✓	✓	✓		✓	✓			✓	
▲	FX	✓												
	FX1 Simple delay	✓												
	FX2 Warm hall	✓												
	FX3 Audio Enhancer	✓												
	FX4 Percussion chorus	✓												
	FX5 Vocal Unison	✓												
▼	Graphic EQ				✓									
▼	Control Groups								✓					

change Control Group members       change Snapshots       change Audio I/O devices

change Gang members       change Channel Presets       change Audio Sync

change Bank Layouts       change FX Presets or types in use       Quit to Windows

change Session Structure or overwrite files

# Chapter 2 - The Master Screen

## 2.1.5 Signal Over Indicators .....

Pressing this entry in the **System** menu opens the **Signal Overs** panel, showing details of any signals which have peaked. Touching an entry in the Signal Overs list brings the channel to the surface to be adjusted. The **Signal Overs** panel also duplicates the **Clear Over Indicators** button.

*Note that the Signal Overs panel can also be set to open automatically when a signal peaks. This is done in the Status tab in the Options menu.*

## 2.1.6 Overview Clear Screen .....

Some panels such as the information bar and the status indicators can be dragged with the trackball to external overview screen. To quickly reset the position of these panels back to the Master screen, press the **Overview Clear Screen** button, and select **Yes** in the confirmation pop-up which appears.

## 2.1.7 Keyboard Help .....

The Keyboard Help button opens up a display detailing the console control elements which are available via an external keyboard:

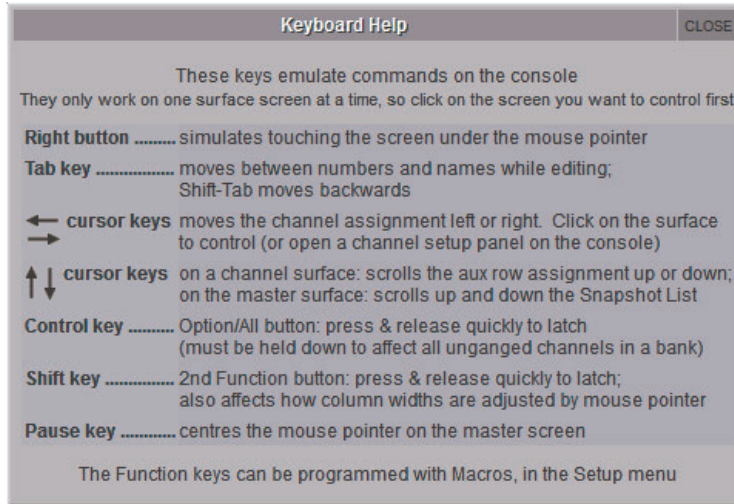

## 2.1.8 F10: Reset FX .....

Pressing this entry in the **System** sub-menu will reset the FX module audio. This allows, for example, lengthy delay and reverb tails to be killed. To complete the reset, select **Yes** in the warning pop-up which appears.

*Note that this will briefly bypass all of the FX units.*

## 2.1.9 F11: Reset Engine .....

Pressing this entry in the **System** sub-menu will restart the audio engine

*Note that this will briefly interrupt the audio - do not use this function unless absolutely necessary.*

## 2.1.10 F12: Reset Surfaces .....

Pressing this entry in the **System** sub-menu will reset all of the worksurface controls. This function will briefly interrupt the audio on the Local I/O only.

## 2.1.11 Set Date & Time .....

Pressing this entry in the **System** sub-menu will open the Date and Time window for the console's operating system.

## 2.1.12 Quit to Windows (SD5, SD7) .....

Pressing this entry in the **System** sub-menu quits the SD console software but leaves windows running. If the session is not saved, pressing **Quit to Windows** will bring up a warning display. Press **Yes** to quit without saving, or **No** to cancel the quit.

## 2.1.13 Restart (SD5, SD7) .....

Pressing this entry in the **System** sub-menu shuts the console's control computer down and restarts it. If the session is not saved, pressing **Restart** will bring up a warning display. Press **Yes** to restart without saving, or **No** to cancel the restart.

## 2.1.14 Shutdown .....

Pressing this entry in the **System** sub-menu shuts the console's control computer down. If the session is not saved, pressing **Shutdown** will bring up a warning display. Press **Yes** to shut down without saving, or **No** to cancel the shut down.

## 2.1.15 Shutdown All .....

When consoles, engines or remotes are mirrored together in Full Mirror or expander mode, an additional **Shutdown All** button will appear at the bottom of the system menu. When pressed, it will shut down all SD consoles or remotes which are in either Full Mirror or Expander mirroring modes.

## 2.2 Files Menu

### 2.2.1 Templates .....

Touching on **Templates** in the **Files** menu brings up the **Session Templates** display. This lists any ordinary session files which are located in the folder d:\Templates (or c:\Templates if not on a console), along with key session information.

**Note: If this folder doesn't exist, it should be created manually. The required template sessions can then be copied into it.**

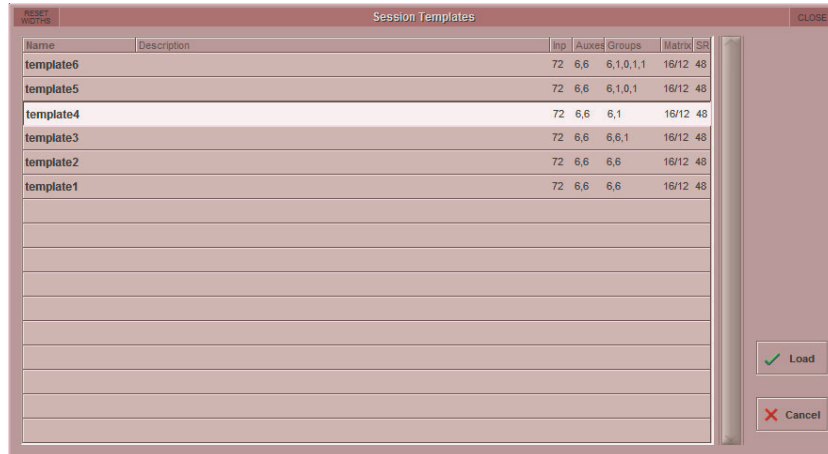

Name	Description	Inp	Auxes	Groups	Matrix	SR
template6		72	6,6	6,1,0,1,1	16/12	48
template5		72	6,6	6,1,0,1	16/12	48
template4		72	6,6	6,1	16/12	48
template3		72	6,6	6,6,1	16/12	48
template2		72	6,6	6,6	16/12	48
template1		72	6,6	6,6	16/12	48

To load a Session Template, simply select it in the list and touch the **Load** button.

### 2.2.2 Session Structure .....

Touching on **Session Structure** in the **Files** menu brings up the **Session Structure** display. This is where a session is named and where the channel allocation and sample rate for the session are configured. While changes to session structure can be made once a session has been started, it is best to try and set these parameters before configuring the session. Session Structure changes are not implemented until the **Restructure** button in the bottom right-hand corner of the display is pressed.

To name the session, touch the **session title** box, type the session name using either the on-screen or external keyboard, and press **OK**.

Set the Session sample rate at the top of the panel.

It is worth remembering that each output (buss) allocated also uses up one of your processing channels.

Below the session title, each channel type has its own setup row, which includes **clear all** and **auto-route** buttons, and a display of the current number of channels in the session. To adjust any of the channel allocations, touch on the associated channel count box, and either enter a number using the pop-up number keypad, or adjust using the assigned touchturn controller.

The SD7 is the only SD Series console where all these parameters are adjustable. For example, on an SD8, SD9 and SD11, only the Aux buss and Group buss allocations are adjustable and all other Parameters are fixed.

For specific console model information, please refer to Configuring Session page in the Getting Started Section.

**Note also that processing channels are reserved for the master buss, talkback channel and stereo solos.**

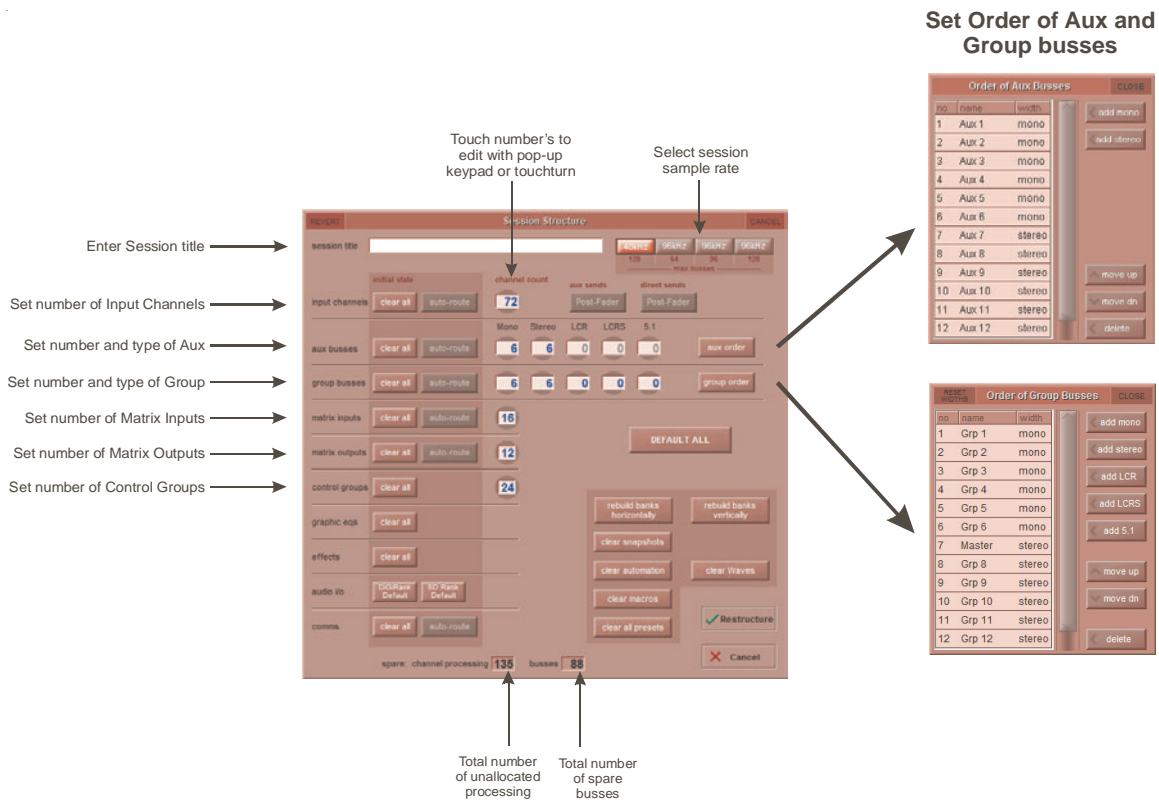

**Note - The Above picture shows the SD7 Session Structure Panel. Pressing the Default All button followed by the Restructure button will automatically configure a new session with the following setup where the inputs from Port 1 are routed to input channels and the Master Buss is routed to Local outputs 1 & 2 and also to Port 1 rack outputs 1 & 2. All input channels will be routed to the Master Buss and the console headphones will be fed by the Master Buss when nothing else is soloed.**

If the **clear all** button is pressed, any non-default routing or processing (EQ, dynamics etc) will be cleared from the channels in the session when the **Restructure** button is pressed. This is especially useful when restructuring an existing session to make a new session.

The **auto-route** button automatically routes the physical inputs and outputs in the rack to the inputs and output channels in the session when the **Restructure** button is pressed, thus saving the operator from manually routing them in the channel **Setup** and **Output** displays. For example, auto-routing 48 inputs will route the first physical input (eg 1: Mic 1) to input channel 1, the second physical input (1: Mic 2) to input channel 2 until you either run out of inputs or channels. Auto-routes are as follows:

- Input Channels auto-route with physical inputs
- Aux, Group and Matrix Channels auto-route to physical outputs
- Matrix Inputs auto-route with group outputs

**Note that auto-routing can only be used in conjunction with the Clear All button, and is not available for input channel direct outs.**

**Important Note: auto-routing overwrites any previous input and output routing.**

**Note also that the outputs of Aux, Group and Matrix channels are auto-routed in sequence: Aux outputs followed by Group outputs, followed by Matrix outputs.**

The send point for input channel direct outs can be set globally using the **direct sends** button toward the top right-hand corner of the display. The button is made active by touching the input channels **Clear All** button. The **direct sends** button then toggles between **Post-Fader**, **Pre-Fader** and **Pre-Mute**.

Similarly, the send point for aux channel outputs can be set globally using the **aux sends** button to the left of the **direct sends** button. The button is made active by touching the aux busses **Clear All** button. The **aux sends** button then toggles between **Post-Fader**, **Pre-Fader** and **Pre-Mute**.



### Aux and Group Order

By default, the aux and group channels are ordered with the stereo channels following the mono channels. These orders can be altered in the **Order of Aux Busses** and **Order of Group Busses** displays, accessed by pressing the **Aux Order** and **Group Order** buttons on the right hand side of the display.

Busses can be added using the buttons in the top-right of the display. To change a busses position or delete it, touch the buss in the display's list and use the buttons in the bottom-right of the display.

**Note that only the mono/stereo format of the Busses and their display within the input channel can be reordered in this display. Channel settings are not reordered. The console layout can be reordered using the Rebuild Banks function described below.**

The Master buss is the first stereo buss, regardless of the order you place the busses in.

The **audio i/o** and **comms** rows beneath the standard channel-type rows allow the settings of the audio io cards and talkback function to be reset.

The **clear snapshots** and **clear macros** buttons towards the bottom-right of the window can be used to clear any existing snapshots and macros when making a new session.

**Note that the clear automation function has not yet been implemented.**

**Rebuild Banks** : When changing the number of allocated channels in any section (input channels, busses etc), you can restructure the session without rebuilding banks, meaning that any additional channels you have allocated will not be "placed" on the worksurface, and need to be manually assigned to faders. If however, you restructure a session with **Rebuild Banks** (either **Horizontally** or **Vertically**) enabled, the worksurface will be built with all channels available on the worksurface in a default layout. Rebuilding horizontally will result in input channels being spread across the top layer of both sides of the console, using as many banks as required, with output channels being assigned to Layer 2. Rebuilding vertically will result in input channels being assigned to Layer 1 on the left side of the console, and output channels to Layer 1 on the right. See the Session Structure section of Chapter 3 for more details.

**Note that when Rebuild Banks is used, any non-default configuration of the channel layout is lost.**

To implement changes in the **Session Structure** display touch the **Restructure** button in the bottom right-hand corner. To exit the display without implementing the changes, touch **Cancel**, located below the **Restructure** button.

To clear unimplemented changes from the display, touch **REVERT**, located in the top left-hand corner of the display.

### 2.2.3 Load Session .....

Touching this entry in the **File** menu opens the **Load Session** display. The left-hand column of the display shows the file directory. At the top of the directory are two buttons which switch the list of folders below them between the contents of the console computer's **internal** d:\Projects folder and the contents of a **removable** USB drive. Each folder can be expanded by clicking the + symbol to its right. The list can be scrolled using the scroll bar to its right.

When a folder or sub-folder in the left-hand directory is expanded, a list of the session files contained within it appears in the list in the centre of the screen. The list displays the **Filename**, creation **Date & Time**, and **Description** of the session. In addition, the list also displays the number of **Inputs**, **Auxes** (mono, stereo), **Groups** (mono, stereo) and **Matrix** channels (ins/outs).

To load a session, touch the session in the list and press **Load**, located in the bottom right-hand corner of the display. To close the display without loading a session, press **Cancel**, located below the **Load** button and also found in the top right-hand corner of the display.

Once a session is loaded, a summary of the currently loaded session is displayed in the **Information Bar** which is normally found on the Master screen. Once any changes have been made to the session, the **File:** indication in this display will only show the folder of the most recently saved session, not the file name.

**Note also that if any of the buttons in the right-hand column of the window are active, sessions cannot be selected for loading from the list.**

# Chapter 2 - The Master Screen

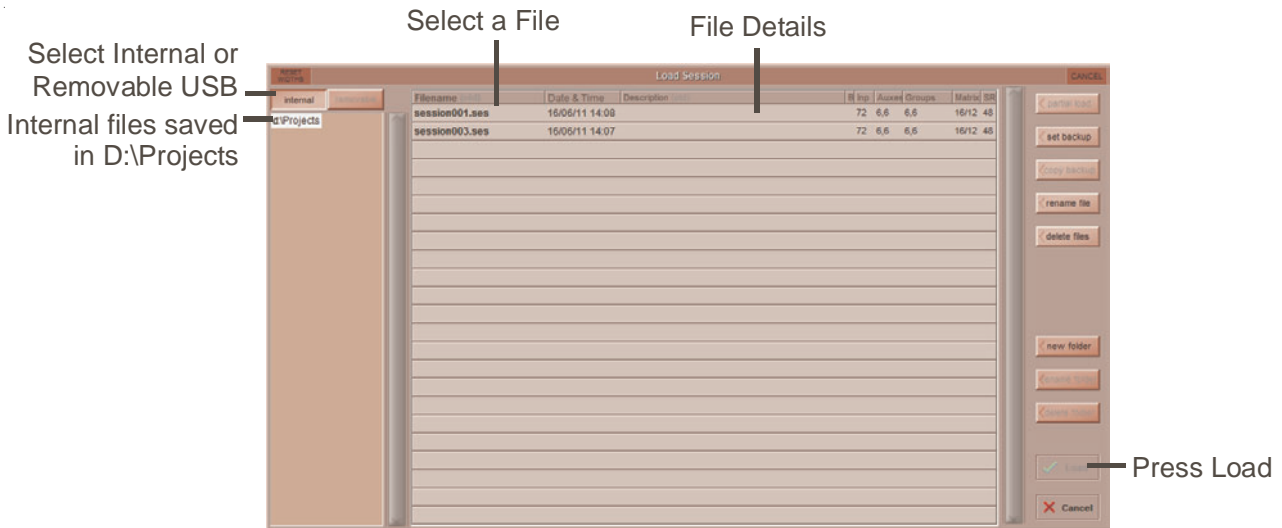

*Note that column widths can be adjusted by dragging their borders within the title row. To return all columns to their default widths, press RESET WIDTHS, in the top left-hand corner of the window.*

## Partial Load

When a session file is selected from the list, the **Partial Load** button becomes available in the top right corner of the panel. Pressing this button opens the panel shown below where elements of the session can be selected for Partial Loading. Possible selections include ranges of Input channels, Matrix inputs, Matrix outputs and Graphic EQs, banks and layout, Presets and Macros.

There are also options to Partial Load all or some of the Snapshots from the selected session.

**Replace Snapshots** will remove the existing Snapshot list and replace it with the partially loaded one.

**Add Snapshots** will open a Snapshot list where snapshots can be selected to be imported into the existing session.

*Note that if Snapshots are imported that contain data that the existing session is not capable of recalling (eg channels that don't exist) then this data will be ignored when the Snapshot is recalled.*

*The numbering of imported Snapshots will be the same as their original numbers so there may be duplication in Snapshot numbers after the import.*



**2.2.4 Save Session .....**

Touching this entry in the **File** menu saves the current session. Once the session has been saved, a confirmation pop-up appears displaying the location of the saved session file.

Note that this function overwrites the most recently saved session. If you want to retain the most recently saved session, save the current session as a new session.

**2.2.5 Save As New File .....**

Touching this entry in the **File** menu opens the **Save Session** display. At the top of the display are two text boxes showing a **file name** and **session title**. The **file name** will normally be 'sessionxxx.ses' where xxx is an auto-incrementing number and the **session title** is the same as the current session. If the session has not been changed since it was last saved, the file name will be the same as the current session. To edit the **file name** and **session title**, touch the relevant text box, enter the new name or title in the on-screen or external keyboard, and press **OK**. To overwrite another session, or to save the session in a new folder but with a previously used name, touch the session of that name and its name will appear in the **file name** box.

The location of the session file to be saved is defined in the directory in the left-hand side of the display. At the top of the directory are two buttons which switch the list of folders below them between the contents of the console computer's **internal** d:\Projects folder and the contents of a **removable** USB drive. Each folder can be expanded by clicking the + symbol to its right. The list can be scrolled using the scroll bar to its right. Touch the button and folder within which you want to save the session.

To create a new folder, select the location for the folder in the way described above, touch the **new folder** button in the right-hand side of the display, type the folder's name using the external keyboard and press the external keyboard's return button. To rename a folder, touch the folder within the directory, touch the **rename folder** button in the right-hand side of the display, type the folder's new name using the external keyboard and press the external keyboard's return button.

To delete a folder, touch the **delete folder** button in the right-hand side of the display, touch the folder to be deleted and touch **Yes** in the confirmation pop-up which appears.

*Note that this action cannot be undone.*

Once the session has been named and its save location has been selected, save the session by pressing **Save**, located in the bottom right-hand corner of the display. To close the display without saving, press **Cancel**, located below the **Save** button and also found in the top right-hand corner of the display. If you attempt to save the session under a file name which already exists within that folder, a pop-up appears, warning that continuing will cause the file with that name to be overwritten. Touch **Yes** to continue, **No** to cancel.

*Note that overwriting the most recently saved session can be performed more quickly using the Save Session function described above.*

Once the session has been saved, a confirmation pop-up appears displaying the location of the saved session file.

To rename a file, touch the file to be renamed followed by **rename file**, located in the right-hand side of the display, enter the new name into the on-screen or external keyboard and press **OK**. If **rename file** is pressed without a file being selected, the first file in the list will be automatically selected for renaming.

*Note that the file name is the only file element that can be edited once the file has been saved.*

To delete files, select the folder containing the files to be deleted and touch **delete files**. To delete all files in the folder, touch **select all**, followed by **confirm delete**. To delete one file or a selection of files, touch the files you wish to delete followed by **confirm delete**. To delete a consecutive range of files, touch **select range**, touch the first and last files included in the range to be deleted, and touch **confirm delete**. To complete the deletion process, touch **Yes** in the confirmation pop-up which appears.

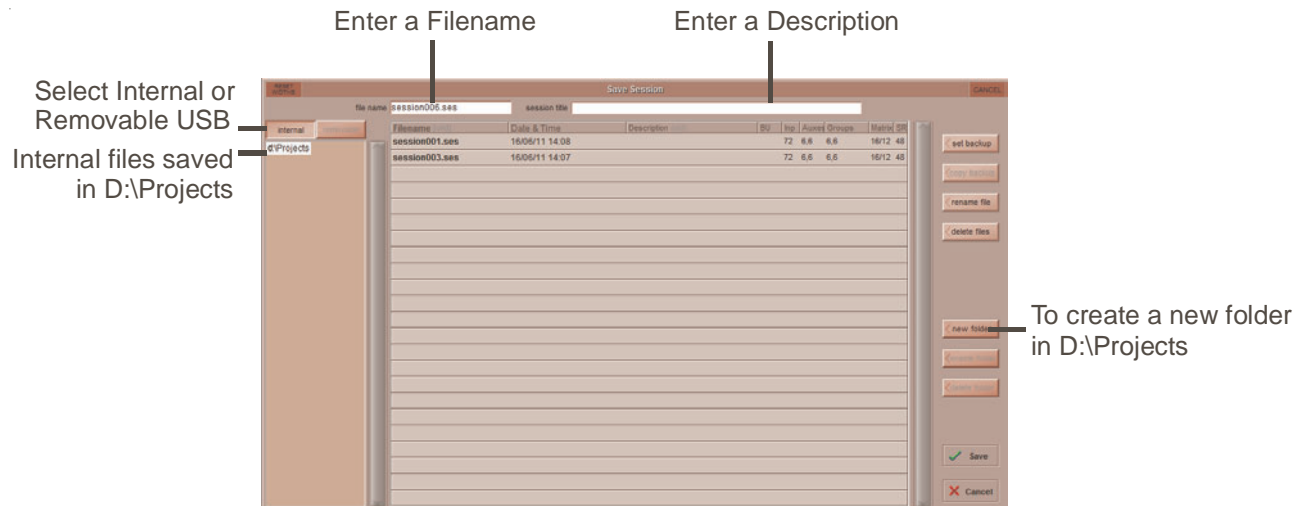

# Chapter 2 - The Master Screen

---

*Note that column widths can be adjusted by dragging their borders within the title row. To return all columns to their default widths, press **RESET WIDTHS**, in the top left-hand corner of the window.*

## Set Backup

Located on the right hand side of both the **Load Session** and **Save as new file** panels, are the **Set backup** and **Copy backup** Buttons. The backup function enables batch copying of session files to and from a connected removable drive. Press the **set backup** button and touch on the session files to copy to/from the removable drive. Once selected, an asterisk will appear in the "B" column of the panel. Now press the **copy backup** button and after the confirmation stage, the selected session files will be copied to/from the removable drive.

*Note that the **Copy Backup** button will not be available until a valid removable drive has been connected to the console's **USB port**.*

## 2.2.6 Load Presets .....

Touching this entry in the **File** menu opens the **Load Presets** display. This allows Channel, FX, Graphic EQ and Matrix presets created in other sessions to be imported into the current session. The left-hand column of the display shows the file directory. At the top of the directory are two buttons which switch the list of folders below them between the contents of the console computer's **internal** d:\Projects folder and the contents of a **removable** USB drive. Each folder can be expanded by clicking the + symbol to its right. The list can be scrolled using the scroll bar to its right.

When a folder or sub-folder in the left-hand directory is touched, a list of the Preset files contained within it appears in the list in the centre of the screen. The list displays the **Filename**, creation **Date & Time**, and **Description** of the preset file. In addition, the list also displays the number of **Input**, **Out** (fx), **GrEQ** (Graphic EQ) and **Matrix** presets contained within the preset file.

To load a set of presets, touch the preset file in the list and press **Load**, located in the bottom right-hand corner of the display. To close the display without loading a session, press **Cancel**, located below the **Load** button and also found in the top right-hand corner of the display.

*Note that a session's presets are also saved as part of the session file.*

*Note also that if any of the buttons in the right-hand column of the window are active, sessions cannot be selected for loading from the list.*

## 2.2.7 Save Presets .....

Touching this entry in the **File** menu opens the **Save Presets** display. At the top of the display is a text box showing the **file name** of the most recently created presets file. It will normally be 'presetsxxx.pre' where xxx is an auto-incrementing number. To edit the **file name** touch the text box, enter the new name or title in the on-screen or external keyboard, and press **OK**. To overwrite another file, or to save the file in a new folder but with a previously used name, touch the file of that name and its name will appear in the **file name** box.

The location of the presets file to be saved is defined in the directory in the left-hand side of the display. At the top of the directory are two buttons which switch the list of folders below them between the contents of the console computer's **internal** d:\Projects folder and the contents of a **removable** USB drive. Each folder can be expanded by clicking the + symbol to its right. The list can be scrolled using the scroll bar to its right. Touch the button and folder within which you want to save the session.

Once the presets file has been named and its save location has been selected, save it by pressing **Save**, located in the bottom right-hand corner of the display. To close the display without saving, press **Cancel**, located below the **Save** button and also found in the top right-hand corner of the display. If you attempt to save the set of presets under a file name which already exists within that folder, a pop-up appears, warning that continuing will cause the file with that name to be overwritten. Touch **Yes** to continue, **No** to cancel.

*Note that a session's presets are also saved as part of the session file.*

**2.2.8 Global Set To Defaults .....**

The **Global Set to Defaults** Panel, opened via the **Files** menu, allows certain settings to be applied globally to the console. Select the Channel type from the list on the left side of the panel, and then select the action from the list to the right. Most actions are self explanatory, with the possible exception of the following:

- **blend LR only** moves all the **lr/lcr** blend controls to **lr**
- **blend LCR** moves all the **lr/lcr** blend controls to **lcr**
- **groups off** unroutes all sends to Groups

*Note that multiple channel types can be selected simultaneously,*

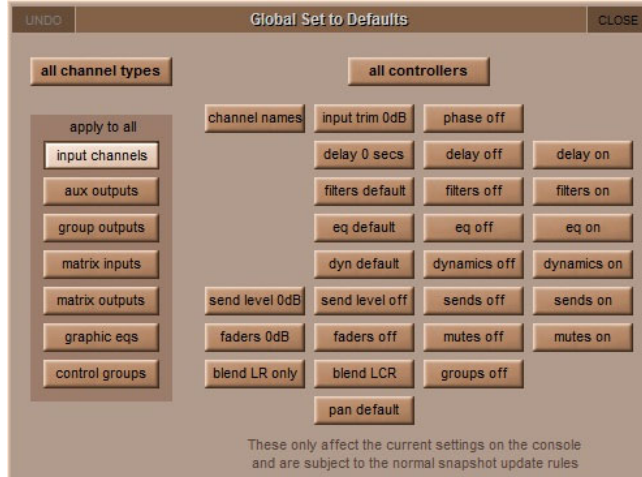

The **undo** button in the top-left undoes all changes since the panel was opened. Once the panel is closed, changes cannot be undone.

**2.2.9 Session Notes .....**

The **File** menu **Session Notes** button opens a panel in which can be used for saving any important session information:

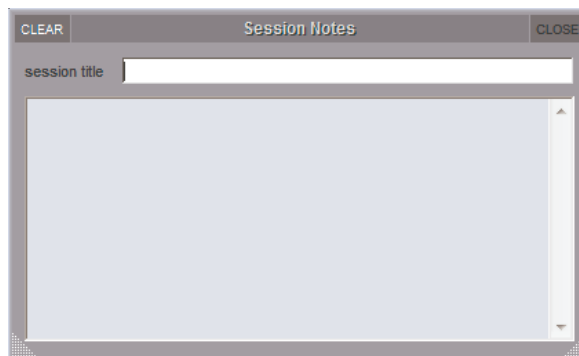

**2.2.10 Session Report .....**

In the **Files** menu there is also a **Session Report** button. This lists the session details on the master screen in an RTF compatible format.

Across the top, the three **include** buttons can be used to define what optional extras are included in the report: **channels**, **audio i/o** and **snapshots**.

The **save to internal** button at the top right of the panel will save the report in the D:\Projects as the session file name suffixed with .rtf. The **save to removable** will save the report to any USB drive insert in the consoles USB port.

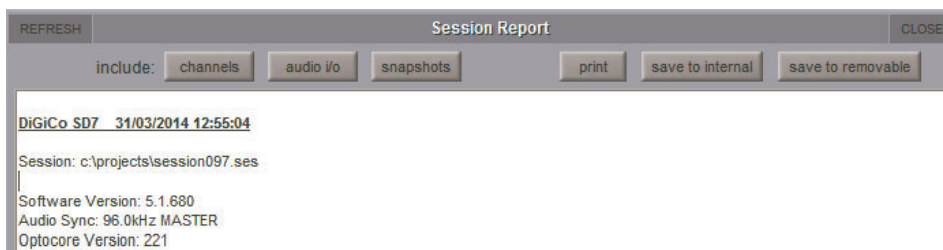

# Chapter 2 - The Master Screen

## 2.3 Layout Menu

### 2.3.1 Fader Banks .....

*Note that not all of the functions described in this section are available on all console models. The example below represents the full set of functions from an SD7.*

Touching on **Fader Banks** in the **Layout** menu brings up the **Fader Banks** display. This display allows the location of each fader bank to be altered. The bank buttons available within each layer of each section of the desk are displayed with their current fader set, with the left and right section banks on the left and right and the master banks down the middle. Towards the bottom of the display there are a number of grey function buttons which turn light-grey to indicate that they have been selected.

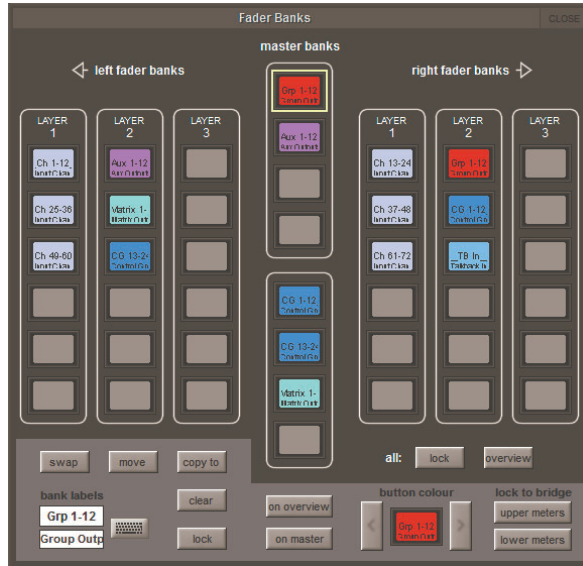

The SD7 Fader Banks panel

To swap the locations of two fader sets, touch one set's bank so that it is highlighted in yellow, touch **swap** (located below the left fader bank's layer 1) and touch the other set's bank.

To move a fader set to a new bank location, highlight the fader set you wish to move, touch **move** (located to the right of the **swap** button) and touch the bank to which you wish to move it. If there is currently a fader set in the destination bank, the current fader set will shift down one, as will any other sets below it until there is a blank bank which can be filled. If a fader set located in the lowest bank of a layer is shifted down, it will move to the first bank of the next layer. If there are no spaces between the selected destination bank and the end of the console section, a pop-up appears indicating that the move cannot be completed.

To copy a fader set to a new bank location, highlight the fader set you wish to copy, touch **copy to** (located to the right of the **move** button) and touch the bank to which you wish to copy it. If there is currently a fader set in the destination bank, it will be overwritten.

To clear a bank, highlight the fader set you wish to copy, and touch **clear** (located below the **copy to** button). Banks can be protected from being accidentally cleared by locking them: Touch the bank you wish to lock and touch **lock** (located below the **clear** button). On SD7, the **lock** button will turn light grey whenever a locked bank is highlighted. All banks can be locked by pressing the **lock** button to the right of the **all:** legend, underneath the right fader banks in the display.

*Note that locked banks can still be moved and overwritten. If a locked bank is moved, the lock function stays with the fader set, not the bank location.*

The labelling within the bank LCD buttons can be edited using the text boxes in the bottom left-hand corner of the display. By default, the top row of the button displays a short version of the channel type (**Ch** for input channels, **Aux** for aux channels, **Grp** for group channels, **Matrix** for matrix channels and **CG** for control group channels) followed by the channel number range, and the bottom row displays the channel type in full. To edit the either row, touch its text box, type in the new name using the on-screen or external keyboard and press OK. The keyboard symbol to the right also activates the naming function for the top row.

*Note that this label affects the bank button displays, not the channel faders within the bank.*

On an SD7, the colour of the bank LCD buttons can be altered using the **button colour** buttons in the bottom right-hand corner of the display. By default, the LCD buttons are coloured to match the colour of their channel type: Light-blue for input channels, purple for aux channels, red for group channels, light-green for matrix channels and dark blue for control group channels. The arrow buttons either side of the **button colour** legend can be used to cycle through the available colours, and the current colour selection is displayed in between them.

*Note that all of the default channel type colours are available for all bank buttons.*

The SD7's upper and lower master meter bridge rows can be locked to any of the eight banks on the master screen. This is done by pressing the **upper meters** and/or **lower meters** button which appear in the lower right-hand corner of the **Fader Banks** panel when a **master bank** button is selected. The **master bank** button will become outlined in red to indicate that it is locked to a row of the bridge.

### 2.3.2 The Overview Display .....

A miniature graphic of each fader set can be displayed on the master screen, or on a separate screen connected to the **Overview** VGA output on the back of the console. These graphics display the fader position, mute, solo status and insert status, and the meter for the channels within all displayed banks. The parameters displayed in this overview can also be adjusted on the overview screen using the external mouse. The **on overview** and **on master** buttons, located below the **Fader Bank** display's master banks, are used to include and exclude fader banks from the external overview display and the master panel respectively. All banks can be included in the overview display by pressing the **overview** button to the right of the **all:** legend, underneath the right fader banks in the display.

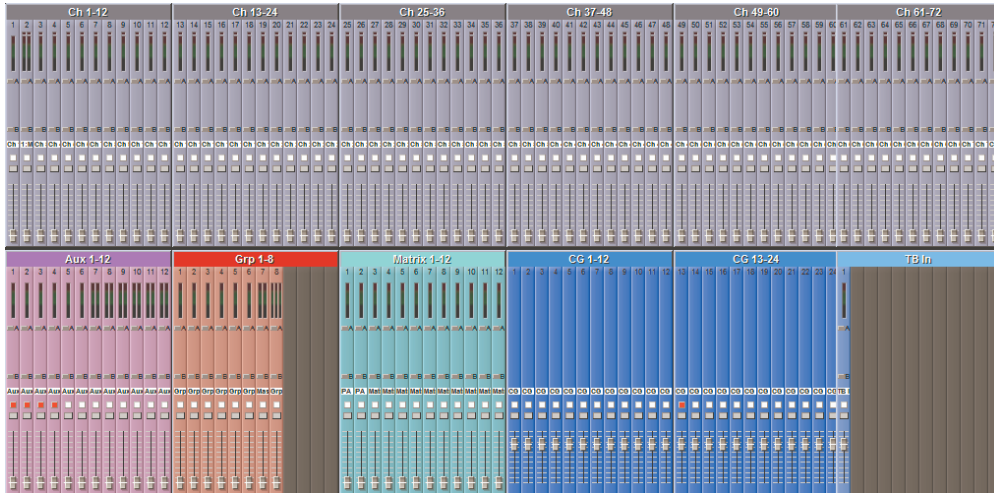

### 2.3.3 Channel List .....

Touching on **Channel List** in the **Layout** menu brings up the **Channel List** display, containing a complete list of all the input, aux, group, matrix and control group channels which exist within the session. The channel list for each channel type can be expanded and collapsed by touching anywhere in the channel type's row. Channel Type rows can be distinguished from the specific Channel rows by their slightly darker colour.

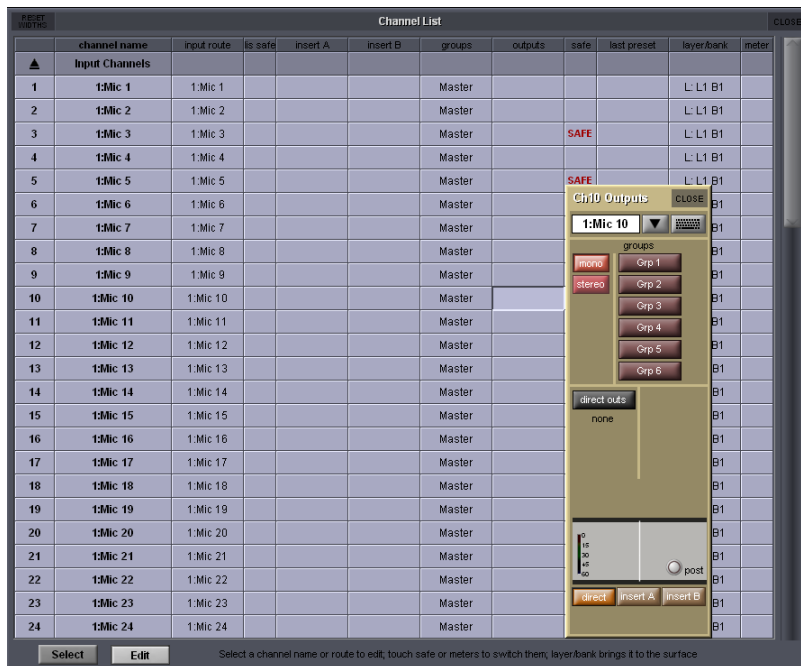

If the **Edit** button at the base of the display is active (lighter), touching the **input route**, **insert A**, **insert B**, **groups** or **outputs** box for a channel will open up the appropriate **Setup** or **Routing** panel for that channel, allowing that routing to be edited. Touching the **safe** box will cause all of that channel's safes (and those of any linked channels) to be activated.

## Chapter 2 - The Master Screen

---

If the **Select** button at the base of the panel is active, the display can be used for adjusting the bank assignments of the session's channels. This function employs the **ASSIGN FADERS** LCD function mode. The channel's current assignment is shown in the layer/bank box: The surface (**L** or **R**; Master fader assignments are not shown), layer (**L**) and bank (**B**).

*Note that when new channels are added to a session, or when a session is created, all of the existing channels can be assigned to the worksurface using the rebuild banks function within the Session Structure display.*

In **Select** mode, the display can also be used for assigning a channel to the worksurface controls. This is done by touching a channel within the list, and also results in the channel's bank being displayed in the appropriate side section of the console. If the channel appears more than once within the session layout, the lowest bank in which it appears is the one which will appear on the worksurface.

With either **Select** or **Edit** active, touching in a channel's **meter** box will cause a small meter panel for the channel to be displayed in the Master screen. This meter display remains active regardless of whether or not the channel itself is currently on the worksurface. It is possible to permanently display up to 12 channels in this way. Pressing the **View** button at the bottom of any of these meters also allows them to be snapped to a grid, sized to either large or small, removed, and moved between the Master screen and Overview screen.

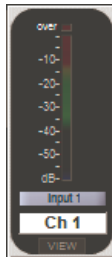

The most recent Preset used on the channel is also displayed, in the **last preset** box.



**2.3.4 Set Spill .....**

Touching on **Set Spill** in the **Layout** menu brings up the **Set Spill** display, where channel Sets can be configured and spilled onto the console. A Set is simply a group of channels selected from across the console's layers, which can be 'Spilled' onto the worksurface together. They can be made up of a mixture of channel types, and need not have anything else in common. The main part of the display is navigated in the same way as the **Channels List** described above.

To create a Set simply choose a Set column and touch the boxes in that column for each channel you wish to include, expanding the channel types as required. The boxes will all turn the same colour. The box in the channel type's parent rows will also turn the same colour, indicating that some channels of that type are included in the Set. the number of channels included in the Set is shown in the Set's **Spill:** box, above the channels display. Any channels which are included in a Gang are indicated by the Gang's colour being displayed on the right-hand edge of the channel's number box (at the left end of its row in the channel display).

To rename a Set, touch on its **Set Name:** box, type a new name on the on-screen or external keyboard, and press **OK**.

To add all channels from a Control Group, touch the Set's **Add from CG:** box and touch the appropriate CG button from the pop-up which appears. The **Spill:** number will increment to indicate how many channels have been added.

To clear a Set, touch its **Clear:** box and touch **Yes** in the confirmation pop-up which appears.

Sets can be spilt directly from this panel, or assigned to a Macro. To spill a Set from this Panel, touch its **Spill:** box. A tick will appear by the spill number to indicate that the channels are spilt. To assign the Set Spill to a Macro, touch the Set's **Assign Macro:** box to bring up a display of the console's Macro controls; Now select a Macro button. The Macro's bank and position will be displayed in the Set's **Assign Macro:** box.

The Set Spill Direction entry in the Faders tab of the Options menu defines how Sets are spilt onto the control surface.

Sets can be unspilt by pressing their Macro or **Assign Macro:** box, or by pressing the **Layer** button for the console section where the set is shown.

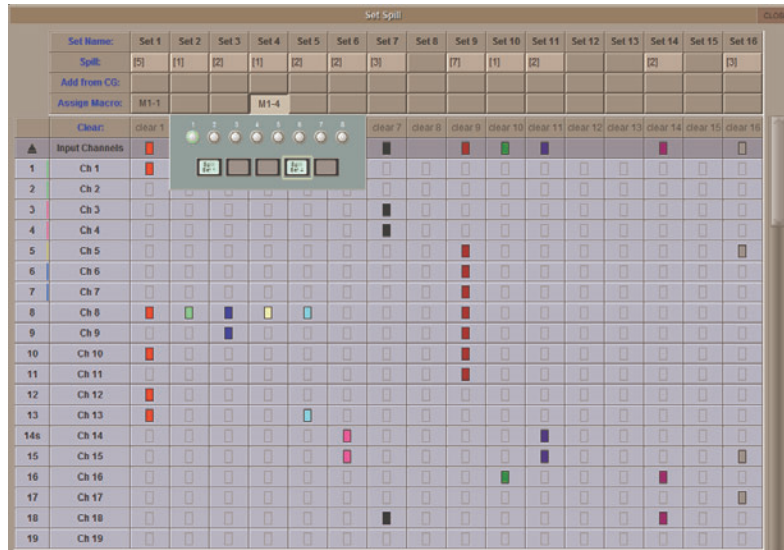

*The SD7 Set Spill panel*

**2.3.5 Transport Control .....**

Touching on **Transport Control** in the **Layout** menu brings up a display of the transport control of an external playback device. Playback devices are controlled via the MIDI connector on the console's back panel. The incoming MTC is also displayed.



Note that control of external playback devices can be programmed within the **Snapshots** screen, as described later in this chapter.

# Chapter 2 - The Master Screen

## 2.4 Snapshots Menu

Any number of Snapshots of the entire current console settings can be stored and recalled using the Snapshots panel. (This is only limited by system memory)

These Snapshots can be independent or grouped with other snapshots.

The recall scope of the snapshot (how many controls it will affect when fired) can be set by controller or by channel.

To display the Snapshots panel, touch the Snapshots button at the top of the Master Screen.

Worksurface controls are detailed in Getting Started.

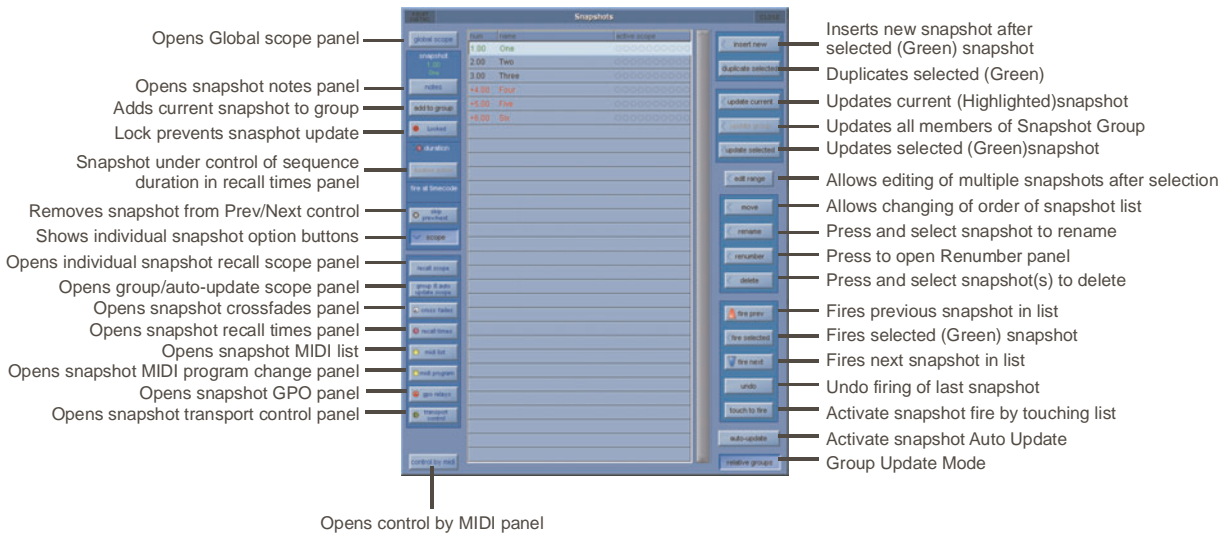

**Note - The current snapshot appears in the panel as the highlighted entry in the list. The snapshot name displayed in green indicates that it is the selected snapshot on the worksurface and its name is indicated in the display. The Fire button recalls this selected snapshot and highlights it in the screen list as the current snapshot.**

**Note also that an 'update Waves only' button appears below the Scope buttons when Waves is active.**

If the current snapshot shows an asterisk next to the number (eg. 001\*) this indicates that a controller has changed since the snapshot was fired.

If a Snapshot name appears in **black** in the list it is a standard Snapshot and if it appears in **red** or **blue** then it is a member of a group of snapshots

### 2.4.1 Storing a Snapshot .....

When a snapshot is stored all the console settings are saved but when the snapshot is recalled its effect can be limited to certain channels and controllers using the **Global** and **Recall** Scopes.

To store a snapshot of the current state of all the console controls, touch the Snapshot panel or worksurface **Insert New** button and a new snapshot will be inserted below the currently selected (green) snapshot. Alternatively, if the **Touch To Fire** function is active, touch an unused button in the list and a new snapshot will be added to the end of the list, then type a name for the snapshot.

Another method of creating a Snapshot is to press the **Duplicate Selected** button and this will create a copy of the selected (green) Snapshot below it.

**Note - If Duplicate Selected is used, the Snapshot that is stored may not reflect the current state of the console's controls - it will simply create a copy of the Snapshot that was selected when the button was pressed.**

### 2.4.2 Recalling a Snapshot .....

There are several ways to recall a snapshot:

- 1) Activate the **Touch To Fire** function using the button on the Snapshot panel and then touch the snapshot button you require.
- 2) The buttons on the Worksurface provide **Scroll Up/Down** buttons to change the selected snapshot named in the worksurface display and listed on screen in green. The **Fire** button then recalls the assigned snapshot.
- 3) The worksurface **Previous** and **Next** buttons can be used to step up and down the list firing snapshots in consecutive order.
- 4) Snapshot firing can also be controlled by specific events on MIDI channel 16 (See Snapshots and MIDI).
- 5) Assign a **Macro** button to fire the Snapshot.

### 2.4.3 Replacing a Snapshot .....

To update or change a snapshot, set the console controls as required and then touch the one of the **Update** buttons (**Current**, **Selected** or **Group**)

*Note - The Current snapshot is not necessarily the one whose name appears in the display on the worksurface, this is the Selected snapshot. For a snapshot to be Current it must have been the last one that was fired and be highlighted in the on screen panel's list.*

### 2.4.4 Editing Multiple Snapshots .....

Individual controller changes can be written to several snapshots simultaneously using the **Edit Range** button. This does not replace all of the data associated with the snapshot, just the elements that are changed at the time.

When the **Edit Range** button is pressed, a panel pops up allowing you to **Select Range**, **Select All**, or select individual Snapshots. You can now select the relevant snapshot(s) from the list.

If you press the **Select Range** button, touching the first and last snapshots in a range will automatically select all the snapshots in that range.

Once snapshots have been selected for editing, press the **confirm** button, or press **cancel** to cancel the **Edit Range** button.

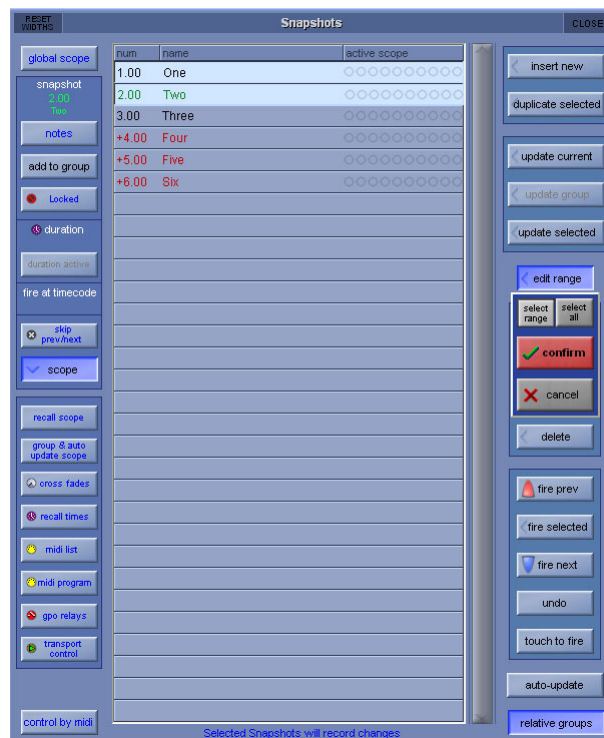

With the **Edit Range** button active, pressing the Snapshot buttons does not fire the snapshots; it only selects them for editing. The selection may be changed by pressing and releasing snapshot buttons at any time during the operation of the Edit command, so a variety of controllers or routes may be changed in a variety of snapshots before completing the operation by pressing the **Confirm** button.

The Snapshots window may even be closed to gain access to other editable functions - In this case, a warning message will appear to advise the user that they are still in snapshot edit mode.

While any Snapshot is selected, changes to any snapshottable controller, routing changes, and any changes to the Snapshot Scope controls can be written to every selected Snapshot, overwriting the previous settings.

Pressing the **Confirm** button keeps the changes.

For example, if Snapshots 1 and 2 are selected and the input gain for channel 1 is changed, subsequent recall of Snapshots 1 or 2 will set channel 1's input gain to the new value.

Only channels which are altered while the Edit command is active will be affected and only in snapshots that are selected at the time.

*Note - Snapshot Scopes and Crossfade Times can also be edited for multiple Snapshots using the Edit Range function*

### 2.4.5 Moving a Snapshot .....

If you wish the Snapshot list to appear in a specific order, you may change the order of the list by moving the entries. Touch the **Move** button and then touch the Snapshot that you wish to move. You then touch the point in the list where the snapshot should be moved to.

### 2.4.6 Renaming a Snapshot .....

To rename a snapshot, touch the **Rename** button, then the name that you wish to change and enter a new name using the keyboard.

# Chapter 2 - The Master Screen

## 2.4.7 Renumbering Snapshots .....

As snapshots can be inserted at any point in the list you may find that you wish to renumber part or all of the list. Press the **Renumber** button at the bottom of the snapshots panel and a new panel will open. Enter the range that you wish to renumber using the touch turn control or by touching the entry and typing and then enter the steps to renumber to (1.00 is the default value). Then press the **OK** button and the list will be adjusted accordingly.

## 2.4.8 Deleting a Snapshot .....

To delete snapshots, touch the **Delete** button and then **Select Range** or **Select All**. If you have pressed **Select Range**, touch the Snapshots in the list that you wish to delete and then press **Confirm**. If you have pressed **Select All**, the complete list of Snapshots will be highlighted and pressing **Confirm** will delete all Snapshots.

*Note - To cancel a Delete operation before it has been confirmed, press the Delete button again.*

## 2.4.9 Snapshot Undo .....

When a snapshot is fired, a separate hidden snapshot of the complete console is stored before the fired snapshot has its effect. If the Undo button is pressed, the hidden snapshot is fired using the same scope as the previously fired snapshot to undo its effect.

## 2.4.10 Snapshot Groups .....

A standard Snapshot (black entry in the list) is an independent snapshot of the current state of all the console controls. A Snapshot can also be a member of a **Group** (red or blue entry in the list). Making Snapshots members of a Group allows all members of that Group to be updated together according to the Group Update mode that is selected. To make a Snapshot a member of a Group, select the Snapshot in the list and press the **add to group** button on the left of the Snapshot panel.

*Note - Snapshots can only be members of the same Group if they are next to each other in the list. There can be several different groups of Snapshots in one list.*

If a Snapshot is a member of a Group, the colour of its entry in the list is determined by the current setting of the **Relative Groups** button in the bottom right of the Snapshots panel. This determines how the Group of Snapshots will be updated when **Update Group** is pressed.

- Red entry in the list = Relative Update mode selected
- Blue entry in the list = Non Relative Update mode selected

### Relative Group Update Mode (Red entries in the list)

If **Update Group** is pressed when the **relative groups** button is **active**, all dB controls such as faders and aux sends will be updated relatively. This means that if a fader is moved by +10dB in one snapshot, the same fader will be moved by +10dB in all Snapshots that are members of the same group, irrespective of the original level of that fader. So +10dB will be applied to the stored level of that fader in all of the Snapshots in the group.

Non dB controls such as Dynamics times, EQ Frequency & Q and Pans will only be changed in members of the group that had the same value for that control before it was moved. So, if one channel pan is in the same position in all the members of a group of Snapshots and you change one of them and press Update Group in Relative mode then the same channel pan will change in the same way in all the other snapshots that are members of that group. If however, any one of the Snapshots in the group has that channel pan in a different position to the current Snapshot then this one will not be changed when you press Update Group.

### Non Relative Group Update Mode (Blue entries in the list)

If **Update Group** is pressed when the **relative groups** button is **not active** then all controls behave in exactly the same way. Changes are only applied to the other Snapshots in the group if the controls that are being changed had the same value as the current Snapshot before the change was made. This is exactly the same behaviour as non dB controllers in Relative mode but in this case all controls are included.

### Group & Auto Update Scope

The behaviour of the Group Update function explained above is also dependent on the **Global Auto Scope** and the **Group and Auto Update Scope** settings that can be set per Snapshot for different types of controls.

Pressing the **Global Scope** button at the top left of the **Snapshot** panel opens the following display:

Global Snapshot Scope																	Close
channel types	input/trim	delay	filters	eq	dynamics	inserts	sends	fader	mute	panner	to groups	outputs	recall	auto	recall	auto	
Input devices	X	X															
Input Channels	✓	✓	✓	✓	✓	✓	✓	✓	✓	✓	✓	✓	✓	✓	✓	✓	
Aux Outputs	✓	✓	✓	✓	✓	✓	✓	✓	✓	✓	✓	✓	✓	✓	✓	✓	
Group Outputs	✓	✓	✓	✓	✓	✓	✓	✓	✓	✓	✓	✓	✓	✓	✓	✓	
Control Groups								✓	✓								
FX	✓	✓															
Matrix Inputs	✓	✓					✓	✓									
Matrix Outputs	✓	✓	✓	✓	✓	✓	✓	✓	✓	✓		✓	✓	✓		✓	
Graphic EQ				✓	✓												
Video Link	X	X															
Output devices																✓	

midi  gpo relays

Horizontal rows show the different sections of the console and the vertical rows show the Recall and Auto Update status for each of the different types of control. A red X indicates not included and a green tick indicates included. These settings can be changed individually by touching the X or tick symbols or by touching the name of a row or column to change all of its contents. Recall Scope is dealt with in the next section but the **Auto scope** columns determine which controls will be included in the automatic group update. Any elements that have a red X will not be updated in any snapshots when **Update Group** is pressed. In the picture above the Input Devices (rack and local input sockets) are not included in the Auto scope so none of their gains or phantom power can be updated using the **Update Group** function. All other elements are ticked and therefore can be included in the **Update Group** function.

**Note - If elements are included in the Global Auto Scope they can still be prevented from Group Updating by the individual Snapshot's Group and Auto Update Scope.**

Selecting a Snapshot in the list and pressing the **Group & Auto Update Scope** button opens the following panel:

	channel name	input/trim	delay	filters	eq	dynamics	inserts	sends	fader	mute	panner	to groups	outputs
▼	Local I/O	✗											
▼	Rack 1	✗											
▼	Rack 2	✗											
▼	Rack 3	✗											
▼	Input Channels	✓	✓	✓	✓	✓	✓	✓	✓	✓	✓	✓	✓
▼	Aux Outputs	✓	✓		✓	✓	✓		✓	✓			✓
▼	Group Outputs	✓	✓		✓	✓	✓		✓	✓		✓	✓
▼	Control Groups								✓	✓			
▲	FX	✓✗											
	FX1 Simple delay	✓											
	FX2 Warm hall	✓											
	FX3 Audio Enhancer	✗											
	FX4 Percussion chorus	✓											
	FX5 Vocal Unison	✓											
▼	Matrix Inputs	✓						✓					
▼	Matrix Outputs	✓	✓		✓	✓	✓		✓	✓			✓
▼	Graphic EQ				✓								
▼	Video Link												

Included for update: all controllers

control group members  gangs

This is similar to the **Global Scope** panel but represents the Group and Auto Update Scope for one individual snapshot which is indicated by its name and number at the top of the panel.

The down arrows on the left of the panel can be clicked to expand the list to show and edit the status of individual sockets and channels for each Snapshot.

Changes in Control Group membership and ganging can also be included or excluded using the tick boxes at the base of the panel. In the picture above the Audio Enhancer input trim has been excluded from the Group Update in this particular Snapshot.

**Note - When using Snapshot Groups it is advisable to set the Global Auto Update scope before attempting to change the update settings for each individual Snapshot. Use of the Global Scope alone probably offers quite sufficient control for most common applications.**

## Chapter 2 - The Master Screen

### 2.4.11 Global Recall Scope .....

When a snapshot is stored all the console settings are saved but when the snapshot is recalled its effect can be limited to certain channels and controllers.

**Note - All elements of console channels and several other features such as Graphic EQ and Effects have their own SAFE settings. If any of these SAFE settings are active then the relevant controls cannot be affected by any Snapshots. This is in addition to the Global Scope settings described here.**

Pressing the **Global Scope** button expands the panel to display and edit the scope for all snapshots.

Global Snapshot Scope														CLOSE										
channel types	input/trim		delay		filters		eq		dynamics		inserts		sends		fader		mute		panner		to groups		outputs	
	recall	auto	recall	auto	recall	auto	recall	auto	recall	auto	recall	auto	recall	auto	recall	auto	recall	auto	recall	auto	recall	auto	recall	auto
Input devices	X	X																						
Input Channels	✓	✓	✓	✓	✓	✓	✓	✓	✓	✓	✓	✓	✓	✓	✓	✓	✓	✓	✓	✓	✓	✓	✓	✓
Aux Outputs	✓	✓	✓	✓	✓	✓	✓	✓	✓	✓	✓	✓	✓	✓	✓	✓	✓	✓	✓	✓	✓	✓	✓	✓
Group Outputs	✓	✓	✓	✓	✓	✓	✓	✓	✓	✓	✓	✓	✓	✓	✓	✓	✓	✓	✓	✓	✓	✓	✓	✓
Control Groups															✓	✓								
FX	✓	✓																						
Matrix Inputs	✓	✓											✓	✓										
Matrix Outputs	✓	✓	✓	✓	✓	✓	✓	✓	✓	✓	✓	✓			✓	✓	✓	✓					✓	✓
Graphic EQ							✓	✓																
Video Link	X	X																						
Output devices																							✓	✓

midi  gpo relays

Horizontal rows show the different sections of the console and the vertical rows show the Recall and Auto Update status for each of the different types of control. A red X indicates not included and a green tick indicates included. These settings can be changed individually by touching the X or tick symbols or by touching the name of a row or column to change all of its contents. The **Recall scope** columns determine which controls will be included in the Snapshot recall. Any elements that have a red X will not be recalled in any snapshots.

In the picture above the Input Devices (rack and local input sockets) are not included in the Recall scope so none of their gains or phantom power can be changed by firing Snapshots. All other elements are ticked and therefore can potentially be changed when a Snapshot is fired.

**Note - If elements are included in the Global Recall Scope they can still be prevented from recall by the individual Snapshot's Recall Scope.**

### 2.4.12 Individual Snapshot Recall Scope .....

Selecting a Snapshot in the list and pressing the **Recall Scope** button opens the following panel:

Recall Scope: Snapshot 2.00														CLOSE
	channel name	input/trim	delay	filters	eq	dynamics	inserts	sends	fader	mute	panner	to groups	outputs	
▼	Local I/O	X												
▼	Rack 1	X												
▼	Rack 2	X												
▼	Rack 3	X												
▼	Input Channels	✓	✓	✓	✓	✓	✓	✓	✓	✓	✓	✓	✓	
▼	Aux Outputs	✓	✓		✓	✓	✓		✓	✓			✓	
▼	Group Outputs	✓	✓		✓	✓	✓		✓	✓		✓	✓	
▼	Control Groups								✓	✓				
▼	FX	✓												
▼	Matrix Inputs	✓						✓						
▼	Matrix Outputs	✓	✓		✓	✓	✓		✓	✓			✓	

Press channel names to change whole row, column headings to change whole columns

control group members  gangs  banks  Waves

The controls that are included in each of the Recall Scope columns can be seen at the bottom of the panel when any of the entries are changed and are as follows:

#### Controllers

**Input/Trim (Local I/O and Racks)** - analogue gains, switches and phantom power

**Input/Trim (Input Channels)** - input routes, digital trim, phase, channel name and tubes

**Input/Trim (Aux Outputs/Group Outputs/Matrix Outputs)** - digital trim, phase, delays, buss name and tubes

**Input/Trim (Matrix Inputs)** - input routes, matrix input name and tubes.

**Delay (All channel types)** - Channel delay

**Filters (All channel types)** - HPF and LPF

**EQ (All channel types)** - all controllers except channel HPF and LPF.

**Dynamics (All channel types)** - all controllers except stereo link.

**Inserts (All channel types)** - Insert Send & Return routes and ON/OFF switch

**Sends (Input Channels)** - Aux send levels, ON/OFF & PRE/POST switches and Aux pans

**Sends (Matrix Inputs)** - Matrix send levels and switches

**Fader (All channel types)** - channel fader.

**Mute (All channel types)** - channel mute

**Panner (Input Channels)** - channel pan

**To Groups (Input Channels)** - Input Channel to Buss routing switches

**To Groups (Group Channels)** - Group to Group routing switches

**Outputs (Input Channels)** - Direct output routes, direct gains and ON/OFF switches

**Outputs (Aux Outputs/Group Outputs/Matrix Outputs)** - Output routes and gains

**Outputs (Local I/O and Racks)** - analogue output 10dB pads and AES SRC switches.

### Misc

**Control Group Members** - Control Group label and a complete list of each group's members.

**Gangs** - Channel gang members.

**Banks** - Current assignment for all controllers and selected bank on the worksurface.

*Note that if Waves is active, a Waves scope button is also shown.*

The down arrows on the left of the panel can be clicked to expand the list to show and edit the status of individual sockets and channels for each Snapshot.

### 2.4.13 Snapshot Recall Times .....

In addition to being fired manually, snapshots can be timed to fire automatically in sequence. This is done in the **Snapshot Recall Times** panel, opened by pressing the **scope>recall times** button on the left hand side of the **Snapshots** panel.

Each snapshot can be given a **recall at** time (the timecode value at which the snapshot will fire) and a **duration** (the time lapse before moving onto the following snapshot). Both the **duration** and **recall times** must be activated by ensuring that their **Active** column is ticked. The smallest time units can be switched between 1/100ths of a second and frames using the **duration display** buttons in the bottom right-hand corner of the panel.

The first snapshot can be fired manually in the main **Snapshot** window, if no specific **recall at** time is set. When this snapshot is fired, the next snapshot in the list will automatically be fired after the set time has elapsed and a progress bar in the snapshot's entry in the **Snapshots** panel will show the time remaining until the snapshot is fired. Pressing the **duration active** button while the progress bar is moving will halt the process. The **recall at** time overrides any active **duration** time.

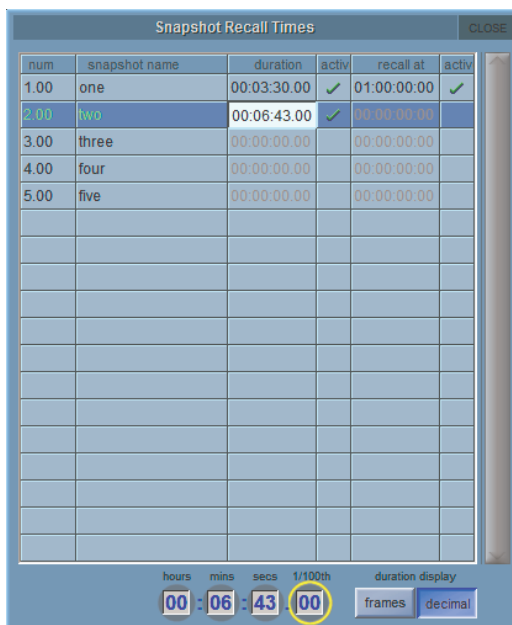

# Chapter 2 - The Master Screen

## 2.4.14 Snapshot Crossfades .....

A crossfade time which is measured in seconds and frames can be applied to different controls in a Snapshot by adjusting the Crossfade Time in the Cross Fades panel. This crossfade occurs as you go into the Snapshot.

Select an individual time by touching it or select a column or row by touching its heading. Then enter a time in the Secs/Frames boxes at the bottom of the panel. Either touch and type or use the Touch Turn rotary to enter a figure.

Different Crossfade times can be applied to input trims, filters, EQs, dynamics, sends, faders and pans.

The down arrows on the left of the panel can be clicked to expand the list to show and edit the status of individual channels for each Snapshot so different Crossfade times can be applied to different channels as well.

A value of zero switches it off.

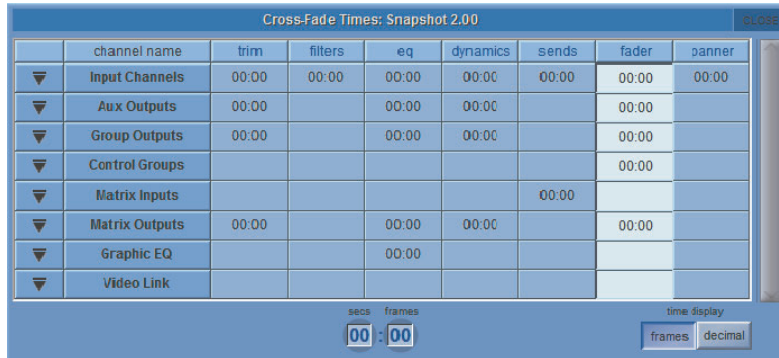

## 2.4.15 Snapshots and MIDI .....

There are two separate areas of MIDI control:

- 1) A snapshot can have a MIDI Message attached to it, and will output that MIDI when fired. The MIDI message must be created in either the **Scope>MIDI Program** panel or the **Scope>MIDI List** panel.
- 2) The firing of snapshots can be controlled by incoming MIDI messages on channel 16, and can cause these same messages to be output in addition to any MIDI List data contained in the snapshot.

The specific MIDI messages that are being responded to can be edited in the **Snapshot Control By MIDI** panel, accessed via the **Control By MIDI** button.

To change the default message for any particular snapshot, select the snapshot and press the **Change** button to select a specific available controller number. The **Clear** button will remove the existing message completely.

The **MIDI Received Fires Snapshots** button allows the Snapshot system to respond by default to the following incoming MIDI messages:

- General Purpose Controller 16; Values 1 to 127 will fire snapshots 1 to 127
- General Purpose Controller 17; Values 0 to 127 will fire snapshots 128 to 255
- General Purpose Controller 18; Values 0 to 127 will fire snapshots 256 to 383.
- General Purpose Controller 19; Values 0 to 125 will fire snapshots 384 to 509.
- General Purpose Controller 19; Value 126 will fire the previous snapshot in list.
- General Purpose Controller 19; Value 127 will fire the next snapshot in list.

When active, the **Fire Snapshot Sends MIDI** button causes the above messages 1 to 509 (or customised versions - see below) to be sent whenever a snapshot button is pressed. **Previous** and **Next** buttons do not output MIDI messages of their own.

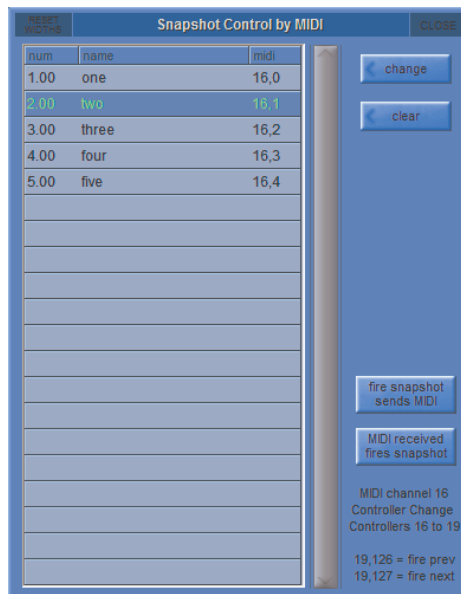



**2.4.16 MIDI Devices .....**

If you intend to send MIDI to external devices it is advisable to first define your receiving devices - this will make the programming of MIDI messages in Snapshots easier to achieve.

Press either the **Scope>MIDI Program** or the **Scope>MIDI List** button and then press the **Devices** button - the following panel will open:

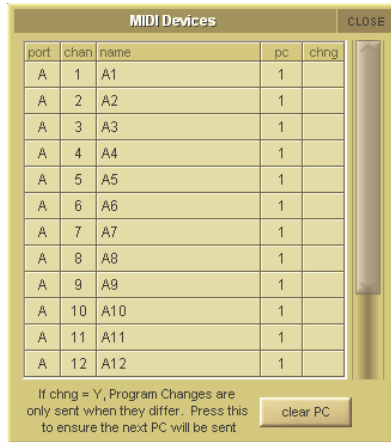

The SD Console's built in MIDI port is referred to as Port A in the **Port** column. Set the receiving MIDI **channel** and **name** for each of your receiving devices and set 1 or 0 in the **PC** column according to whether the device uses 0-127 (0) or 1-128 (1) for its data values. If you don't know this piece of information then leave the setting as 1.

The column marked **Chng** determines whether Program Changes are only sent when they are different to the last sent message (Y) or whether they are always sent irrespective of the last message sent. This would be useful if there was no need to change the program on the receiving device and if you did this it might interrupt the signal passing through the receiving device as its program changes.

The **Clear PC** button at the bottom of the panel ensures that the next message will be sent.

This has defined your devices for later use and the panel can now be closed.

**2.4.17 MIDI Program and MIDI List .....**

The **Snapshot MIDI Program Changes** panel, accessed via the **midi program** button has a column for each of the 16 MIDI channels on Port A and a row for each existing Snapshot. Touch and type, use the value up/down buttons or enter a value using the **Touch Turn** rotary control for each program change that you wish to send with each snapshot and ensure that the **act** (active) box is ticked for each relevant Snapshot. With the **ripple down** button active, entries will be copied to all consecutive following Snapshots that have the same value as the one which was changed or have no value. Once entered, this MIDI information will be sent when the Snapshot is fired.

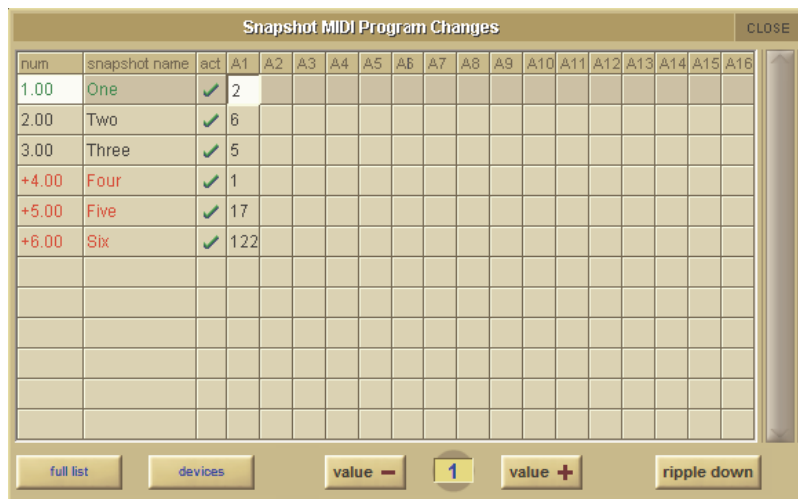

If MIDI program change messages have been entered in this way they will also appear in the **Scope>MIDI List** panel which allows entry and editing of other types of MIDI message.

There are columns for the **midi device** name (mentioned in the last section), the MIDI **Port**, MIDI **Channel**, type of **command** and two **data values**.

*Note - If you have already defined MIDI Devices, selecting one of these in the MIDI Device column will automatically enter the Port and MIDI channel that you have previously entered for that device.*



If you want to send multiple MIDI messages with a single Snapshot, use the **Insert** button to add extra lines for message entry. You can then configure the message by selecting each column in turn, and using the **value** controls to the right of the list. Below the **value** controls is a key for the **command** column.

To test the MIDI message without firing the Snapshot, press the **Send** button - the display at the bottom right of the panel shows the presence of incoming and outgoing MIDI messages.

MIDI messages can also be automatically entered into the list by generating the required message from the external MIDI device, sending this to the console's MIDI In and pressing the **Capture** button.

### 2.4.18 Snapshot GPO Relays

The Snapshot GPO relays panel allows the state of each GPO to be set when a snapshot is fired.

The Global Recall scope for each GPO can be set by touching the appropriate box at the top of the column.

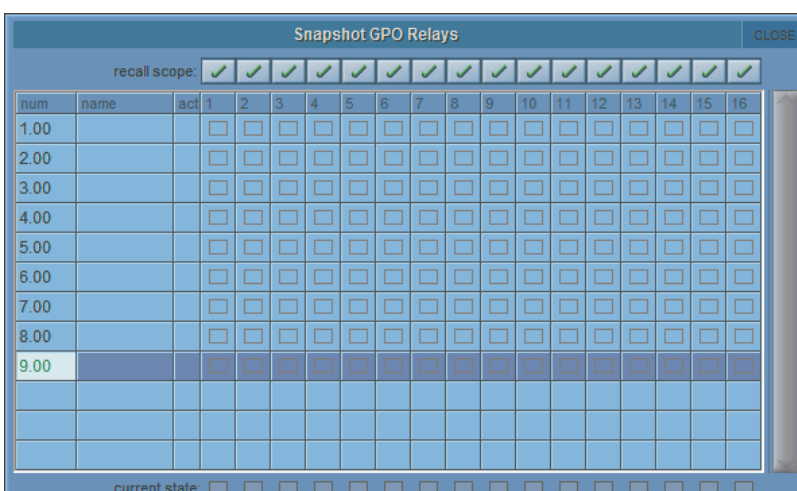

**2.4.19 Surface Offline & Snapshot Editing (Not SD11) .....**

In the Snapshot section of the console worksurface there are 2 buttons labelled **Surface Offline** and **RTN To Audio**. When pressed and held, the Surface Offline button stops the communication between the worksurface controls and the audio engine - this means that anything that is done on the surface of the console will have no effect on the audio passing through the console. Pressing the RTN To Audio button will reconnect the surface controls to the audio engine ignoring any worksurface changes that have been made since the surface was put Offline and returning the console to its state before the Surface was put Offline.

**Important Note - if the Surface Offline button is pressed, worksurface changes are made and the Surface Offline button is pressed a second time, the changes that have been made on the worksurface will immediately applied to the current audio - be careful with this function...!**

The main purpose of the Surface Offline and RTN To Audio buttons is to enable Snapshots to be edited with the worksurface offline so that any Snapshot can be previewed, adjusted and updated without affecting the current audio. While Surface Offline is active any of the Snapshot functions already described can be used.

As an example, if you are currently in Snapshot number one and wish to check or edit Snapshot number two you should:

- 1) Press and hold the Surface Offline button and the audio will continue normally.
- 2) Scroll down and fire Snapshot two to see its settings on the worksurface.
- 3) Edit the settings for Snapshot two and Update either Current or Selected according to requirements.
- 4) Press the RTN to Audio button to automatically put the surface back online and back in Snapshot one.

**2.4.20 Auto Update .....**

The Auto Update button in the Snapshots panel activates automatic updating of the current Snapshot whenever a control is adjusted. The current Snapshot will be updated without using the Update Current, Selected or Group functions. The elements of the Snapshot that are automatically updated is dictated by the Group and Auto Update Scope settings that are described in the Group Snapshots section of this chapter.

**Note - In view of the potential for changing Snapshots without active manual intervention, it is probably advisable to leave this function OFF unless you are absolutely certain that you require it.**

**2.4.21 Snapshots & MTC .....**

Snapshots can also be programmed to send MMC messages, allowing control of external playback devices. Within the snapshot **scope** section, press the **transport control** button. This opens the **Snapshot Transport Control** panel. The panel lists all current session snapshots and allows entry, per snapshot, of the following MMC commands.

- PLAY:** Basic Play command. External device will play from current location
- play from:** External device will play from specified time value
- play to:** External device will stop when the specified time is reached.
- locate to:** External device will Locate to specified time.
- STOP:** Basic Stop command. External device will stop.

Commands can be sent via MIDI, selected at the bottom of this panel.

**NOTE : Correct MMC operation relies on a correctly configured MIDI system, with MTC from the external device connected to the console MIDI Input. If this MTC connection is not present, the MMC snapshot system will not work.**

A Transport Control panel is also provided in the Layout Menu. This provides a MTC readout of incoming MTC, and allows direct control of the external device.



## Chapter 2 - The Master Screen

### 2.4.22 Snapshot Notes .....

Pressing the notes button (towards the top left-hand corner of the main Snapshots panel) opens a notes panel, displaying any notes associated with the current Snapshot. This panel stays open whenever the notes button is active, switching to the next Snapshot when it is fired. The **selected** and **next** snapshots are shown below the text box.

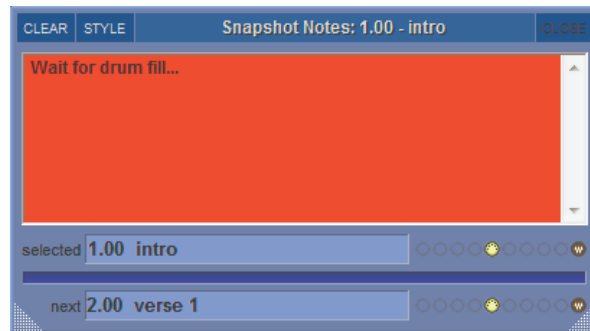

To add notes, simply touch inside the notes space in the centre of the window and type your notes. To clear the text, touch the **clear** button in the top left-hand corner of the panel.

To format the text or background, touch the **style** button (next to the **clear** button) to open the **Notes Style** panel:

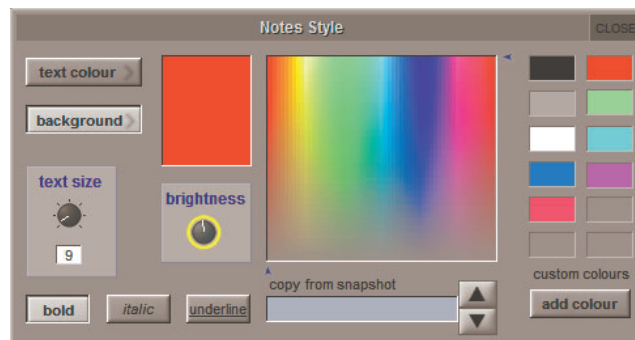

The text can be formatted using the **text size** controller and **bold**, **italic** and **underline** buttons in the left side of the panel. To change the colour of the text or background, select either the **text colour** or **background** button in the left side of the panel, touch inside the colour palette in the centre of the panel, and adjust the brightness using the **brightness** controller. The selected colour is displayed above the **brightness** controller.

**Note that text defaults to minimum brightness (black), and the background to maximum (white). You may therefore need to move the brightness controller towards the middle in order to see the colour content.**

You can save your selected colour as one of the twelve **custom colours** in the right of the panel. To do this, simply select the **add colour** button and touch inside the desired custom colour box.

You can also copy styles from other snapshots using the **copy from snapshot** controls beneath the main colour palette. Use the up and down arrows to move through the snapshot list – the snapshot whose style is currently displayed is shown in the **copy from snapshot** text box.

**Note that copying a style from another snapshot will overwrite the current style.**

### 2.4.23 Snapshot Locked .....

**Note: Only available on non Theatre software versions**

To lock a Snapshot and prevent it from being updated, select the Snapshot and then press the **Locked** button on the right of the panel. It can be unlocked in a similar way.

When a Snapshot is Locked, it cannot be updated using update selected/current or deleted.

## 2.5 Options

The **Options** menu includes a variety of SD system preferences, grouped into nine tabs. Most functions are described fully within the display. Each function's button displays **Yes** in purple to indicate that it is active, and **No** in grey to indicate that it is inactive.

*Note that if Waves is enabled, the Options menu is located in the Setup drop-down menu. See the appendices for more details.*

### 2.5.1 Surface .....

The **Surface** tab includes settings related to the console screen, buttons and encoders:

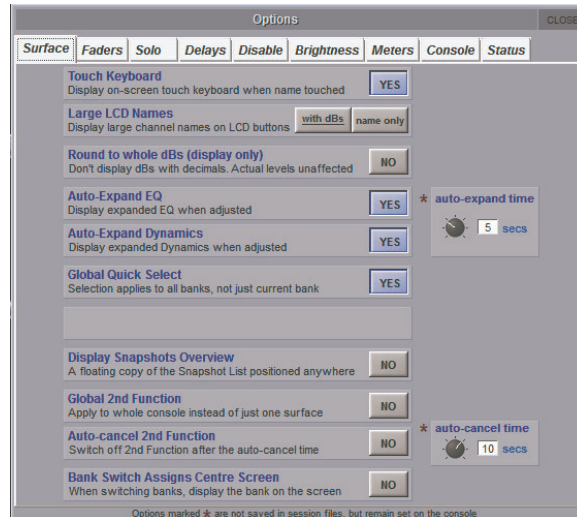

#### Touch Keyboard

This option defines whether or not the on-screen keyboard appears when a name box is touched. It is active by default.

#### Large LCD Names

This option allows the names in the LCD displays to be displayed in a larger font, either with the gain value and solo buss (**with dBs**) or as the channel only (**name only**). It is inactive by default.

#### Round to whole dBs

Fractional dB values are rounded to the nearest integer value.

#### Auto Expand EQ

This option defines whether or not the EQ display opens when an EQ is adjusted. It is active by default.

#### Auto Expand Dynamics

This option defines whether or not the dynamics display opens when an dynamics is adjusted. It is active by default.

#### Auto Expand Time

This pot, located to the right of the **Auto Expand EQ** and **Dynamics** options, defines how long the EQ and dynamics displays remain open after the parameters within them are adjusted. The current setting is displayed in seconds, below the pot. Touching the pot assigns it to the Touch-Turn encoder.

#### Aux To Masters (SD7 Only)

This option allows the all of the aux send levels for one channel to be assigned to the Lower Master faders by pressing that channel's lower aux button (the button in the third row of aux encoders below the Channel strip panel). This is useful if, for example, all of the fold-back sends from one channel need to be adjusted. The function is inactive by default. If there are more than twelve auxes in the session, the Lower **master bank** buttons are used to move between banks of twelve auxes.

*Note that the number of auxes is not divisible by twelve, some faders within the last bank half banks will retain their original function, as indicated by their LCD buttons.*

#### Global Quick Select (SD5, SD9, SD11)

This option defines whether the Quick Select selection will be the same for every bank on a Surface. Note, on the SD5, the selection will be different between the left and right surface.

#### Display Snapshots Overview

This option allows a floating copy of the Snapshots list to be displayed in the overview screen, for the viewing or triggering of Snapshots.

#### Global 2nd Function

This option defines whether the 2nd function button affects just the current surface (**no**) or all surfaces on the console (**yes**).

#### Auto-cancel 2nd Function

This option defines whether or not active **2nd Function** buttons are cancelled after the time defined in the **auto-cancel time** pot to its right. It is inactive by default. Touching the pot assigns it to the Touch-Turn encoder.

## Chapter 2 - The Master Screen

*Note that both the auto-expand time and auto-cancel time values are set on the console and are not saved as part of the session file.*

### Engine A/B Switches Audio (SD7 Only)

This option concerns the **Engine** button in the top left-hand corner of the SD7's master section, shown below, which is used for switching the SD7 to the redundant engine. When this function is inactive, the **Engine** button switches just the console controls; when this function is active, the **Engine** button also switches the audio processing. This function is inactive by default.



### 2.5.2 Faders .....

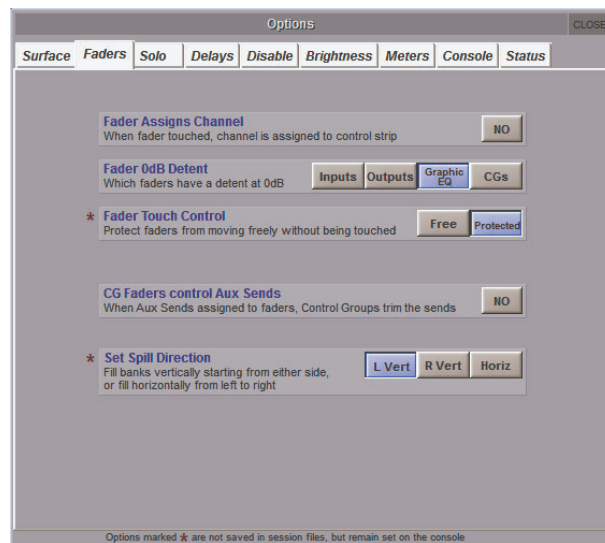

#### Fader Assigns Channel

This option allows a channel to be assigned to the worksurface channel controls whenever its fader is touched. It is inactive by default.

*Note that when this option is active, accidentally touching a fader will assign it to the worksurface controls.*

#### Fader 0dB Detent

This option defines which controls have a detent at 0dB. Options are **Inputs**, **Outputs**, **Graphic EQ** (default) and **CGs**.

#### Fader Touch Control

This option defines whether or not a fader moves when it doesn't detect a touch. Options are **Free** (fader moves freely) and **Protected** (fader is protected from moving without touch).

*Note that this setting is set on the console and is not saved as part of the session file.*

#### CG Faders control Aux Sends

If this option is set to **Yes**, whenever 'Aux to Faders' is activated (by any means), the Control Group faders jump to the middle and become +/-18dB trims for the selected aux send, on all channels which are members of the Group. The fader for Control Groups which have no members will simply close and do nothing. CG Mutes and Solos continue to operate as normal.

#### Set Spill Direction (SD5, SD7, SD8, SD9, SD10)

This option defines the way in which Sets are spilled onto the worksurface: **L Vert** places them on the left side, creating as many banks as are required to spill all the channels in the Set; **R Vert** does the same on the right side; **Horiz** places the first 24 channels across both sides of the console before creating as many banks across both sides as are required to spill all the channels.

### 2.5.3 Solo .....

The **Solo** tab includes settings related to the console's solo functions:



#### **Solo Displays Insert**

This option defines whether or not the display of any internal FX or Graphic EQ inserted on a channel is opened when that channel's solo button is pressed. The Graphic EQ panel can only be displayed on the Master screen. It is active by default.

#### **Solo Assigns Aux to Faders**

This option defines whether or not the send levels to an aux channel are assigned to the channel faders when that aux channel's solo button is pressed. It is active by default.

#### **Solo Assigns Aux to Rotaries**

This option defines whether or not the send levels to an aux channel are assigned to the top row of aux encoders when that aux channel's solo button is pressed. It is active by default.

#### **Aux to Faders includes Pans**

This Option defines whether or not the pan assignment for the under screen rotaries will become the stereo aux pan when a stereo aux is soloed if Solo Assigns Aux to Faders is active.

#### **Solo Assigns Channel**

This option defines whether or not a channel is automatically assigned to the channel worksurface controls when that channel's solo button is pressed. It is active by default.

#### **Solo Reverts to Output**

This option defines what happens if an output channel solo is active when an input channel solo is then activated and deactivated. When this option is active, deactivating the input channel solo will return the solo buss to the output previously in solo mode. When this function is inactive, deactivating the input channel solo will leave all solos inactive.

The option is only available if the solo buss is in **single** mode. The option is inactive by default.

## Chapter 2 - The Master Screen

### 2.5.4 Delays .....

This tab is used for defining the delay units used in the Setup panel of **Input channels**, **Output channels** and **fx channels** (fx units). The options are **seconds** (default), **feet**, **metres**, **bpm** and **frames**.

*Note that these options are also displayed to the right of the numeric keypad opened by pressing the delay's keypad symbol.*

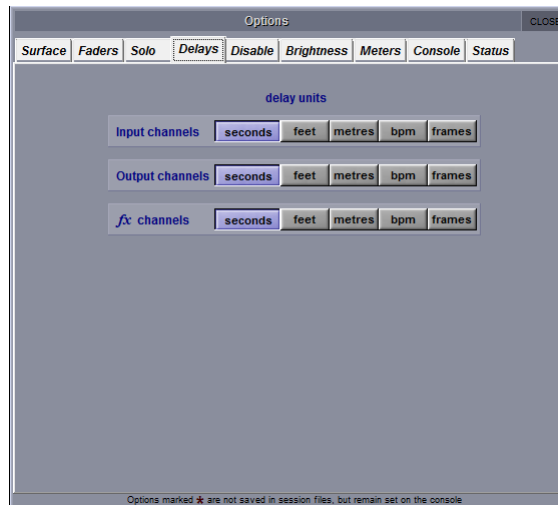

### 2.5.5 Disable .....

This tab is used for disabling worksurface buttons, in order to prevent accidental changes if they are not being used. This function does not affect on-screen operation of the functions: If the Panel will show the options relevant to your console.

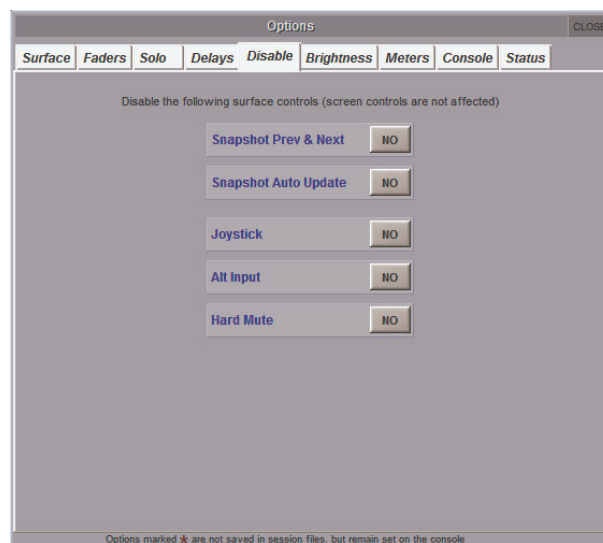



## 2.5.6 Brightness .....

The **Brightness** tab is used for adjusting the brightness of the console's **bridge/Lil lights**, **screens** and **surface leds**. Touching each pot assigns it to the Touch-Turn encoder.

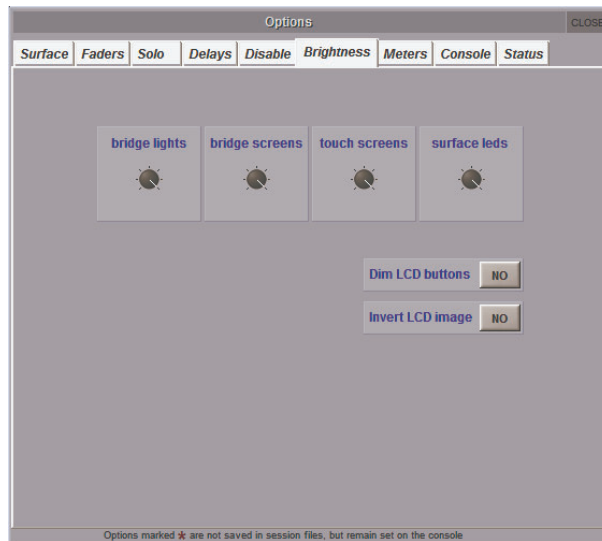

The SD5 and SD7 console's LCD buttons are not controlled by the **surface leds** pot but by the **Dim LCD buttons** and **Invert LCD Image** options towards the bottom of the screen. Note that the dimming option only dims the brighter LCD colours.

## 2.5.7 Meters .....

The **Meters** tab includes settings related to the console meters:



The four pots across the middle of the panel affect the attack and release reaction time (**attack rate** and **release rate**), the **peak hold** time and the **overs hold** time. The current setting for each is displayed in either milliseconds or seconds, below each pot. Touching each pot assigns it to the Touch-Turn encoder. The row of buttons above the pots provide access to a number of preset meter configurations, including the **SD default** and a number of PPM formats.

**Note that when the overs hold time is set to 0, the hold time is set to infinite, not 0. The overs lights will therefore remain lit until they are manually cleared.**

**Note also that if you activate a metering preset and then edit it, the button for the preset on which the setting are based will still appear selected.**

The point being metered within the channel is set using the eight buttons in bottom left of the display. The input channel meters are adjusted using the buttons on the left, and the output channels are adjusted on the right. The options for each are **pre-trim**, **post-trim** (**pre-processing**), **pre-fader** (**post-processing**) and **post fader**. The default setting is **post-trim** for input channels, and **post-fader** for output channels. The currently selected button is displayed in purple.

The **Overview** area in the bottom right of the display allows the size of Input and Output Meters to be set: **small** or **large**.

**Note that the settings in the bottom half of the display affect the meters on the worksurface, not the on-screen meters.**

## Chapter 2 - The Master Screen

### 2.5.8 Console .....

The **Console** tab includes settings related to the console's startup procedure:



#### Load Startup Session

This option allows the startup session to be automatically loaded on system start up. When not selected, the desk will always start up in the default state.

#### Save Startup Session

This option allows the startup session to be automatically saved when quitting. When not selected, the desk will always start up in the same state.

#### Auto-Save Recovery Session

This option enables an auto-save function, which saves the active .ses file regularly, in case it needs to be recovered. The time between auto-saves is defined using the **save every** pot to the right of the option's button.

#### Default Positions

This option allows all windows to be set to their default positions on next launch.

#### Enable Waves MultiRack

This option enables Waves features. Waves is an optional extra which provides a set of Waves plug-ins in addition to the console's own fx units.

**Note: This option should not be enabled unless the console has Waves hardware and software installed.**

Contact DiGiCo if you are interested in purchasing Waves.

#### Enable Optocore

This option allows optocore connections to be switched off if not in use. You can have both optocore loops **OFF**, or you can enable **Loop 1**, **Loop 2** or **Both**.

#### Enable Console Network

This option activates networking for remote control PCs and consoles and is explained in the **Network and Mirroring** section

***Note that Enable Waves MultiRack and Enable Console Network both require a restart for changes to take effect.***

#### Mirroring Mode

This option defines the way control is assigned between networked consoles and is explained in the **Network and Mirroring** section.

#### Single Engine Only (SD7 Only)

When active, this option allows two SD7's with only one engine to be mirrored together.

### 2.5.9 Status .....

The **Status** tab defines whether console status notifications are displayed. All functions are active by default.

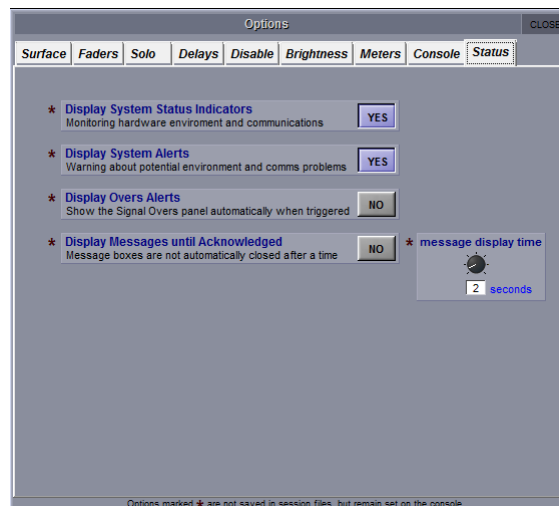

#### Display System Status Indicators

This option defines whether or not the Status display is open. This display provides constant monitoring of various elements of the console's systems. The indication box to the right of each element displays a green **OK** when that element is running correctly, a red error when that element is malfunctioning, and a blank grey box when that element is not relevant. Touching any indication box will bring up the appropriate Diagnostics page, if there is one.

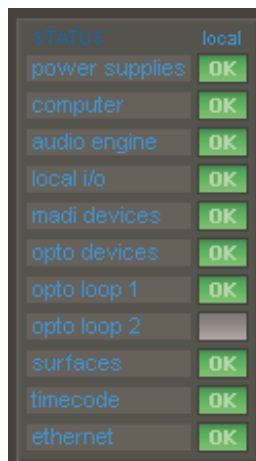

#### Display System Alerts

This option defines whether or not system warnings are displayed. The time for which alerts are displayed is adjusted via the message display time pot, located towards the bottom of the window. The current setting is displayed in seconds, below the pot. Touching the pot assigns it to the Touch-Turn encoder.

#### Display Overs Alerts

With this option active, whenever an input or output over-indicator comes on, the **Signal Overs** panel is displayed showing details of the signals involved and their channels. Touching an entry in the Signal Overs list brings the channel to the surface to be adjusted. The **Signal Overs** panel also duplicates the **Clear Over Indicators** button.

*Note that the Signal Overs panel can also be opened using the Signal Over Indicators option in the System menu.*

#### Display Messages until acknowledged

With this option active, any system alert will remain on the screen until cancelled by the user.

# Chapter 2 - The Master Screen

## 2.6 FX

### 2.6.1 The Master FX Display .....

Selecting the **fx** menu button in the master screen opens the master **fx** display, which shows all of the currently assigned fx units in a single rack. Touching any control in this display allows adjustments to be made using the worksurface **Touch Turn** controls.

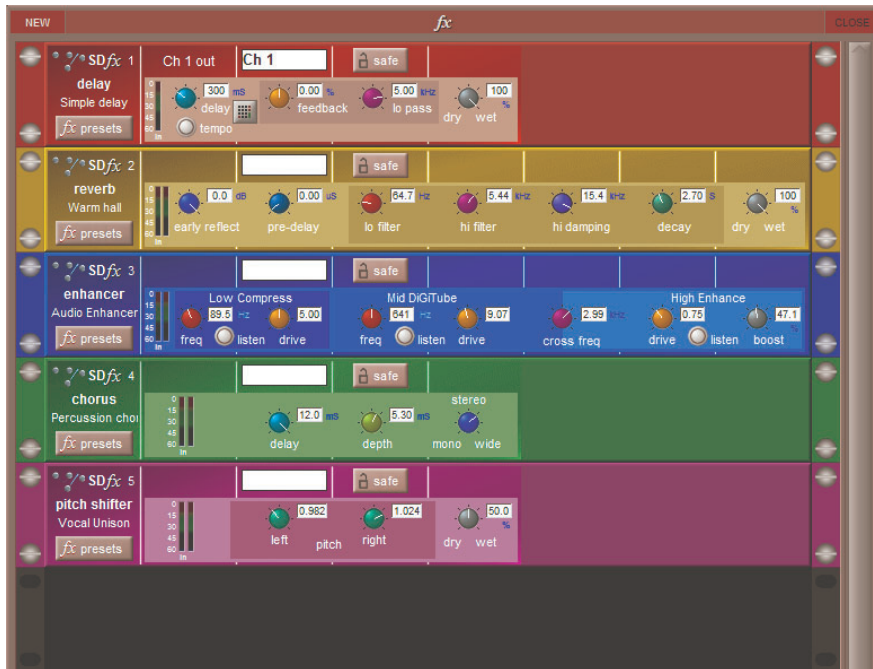

It is also possible to create and delete modules from this display:

To create a new module, click on the **New** button in the top left-hand corner of the fx window to bring up the **fx Presets** display, then select the appropriate preset in the usual way. Routing to fx modules is then performed in the channel **Outputs** display.

To delete a module, click on the **fx presets** button on the module, and deselect the preset in the **fx Presets** display which appears.

A number of factory presets are provided, and these provide the basis for any user-adjusted presets. Factory presets are indicated by the presence of a red padlock in the **lock** column on the right, and are described below. These include stereo FPGA reverbs and other effects such as delays, choruses, pitch shifters and audio enhancers.

Once an effects preset has been adjusted, it can be saved, either as a new preset or as an updated version of the preset that has already been created, to prevent the changes from being lost:

To lock the preset, activate the **edit name** button and touch the preset's **lock** column. A grey padlock appears, indicating that the preset is now locked. Touching the lock again with **edit name** active unlocks the preset. All master presets are locked and cannot be unlocked. Master presets can be distinguished from user presets by the red colour of their padlocks.

**Note - that factory preset group names can be edited, even though the presets themselves cannot.**

Once an effects preset has been assigned, the **fx output** button in the channel strip recalls the preset's controller display. In the case of Input channels, once an effects preset has been assigned, the preset's display can be recalled by touching the pan area of the channel strip. The **fx Presets** display can then be recalled by pressing the **fx presets** button within the controller display.

Each FX unit can be saved by pressing the **safe** button at the top of its display. The channel's name and output are also shown at the top of the display, and each effect displays its input and output levels in meters in the left-hand side of the controller.

**Note -**

**On SD7 up to 16 Stereo Reverbs and additionally up to 32 other effects (dependent on type) can be used at any one time.**

**On SD5 up to 24 FX can be used with maximum of 16 Stereo Reverbs**

**On SD10 up to 16 FX Can be used**

**On SD8, up to 12 FX can be used**

**On SD9, up to 8 FX can be used**

**ON SD11, up to 6 FX can be used (4 on Standard SD11)**

**Note - If Presets are greyed out in the presets list this means that the maximum number of an FX type has been reached**

## 2.7 Matrix Menu

### 2.7.1 The Matrix Panel .....

Touching the **Matrix** menu opens the **Matrix Inputs** panel, which allows matrix inputs to be selected and the level of each input to each output to be set. Each column of the display represents an input to the matrix, and each row represents an output. Each pot within the display trims the signal coming from the input for that column, going to the output for that row.

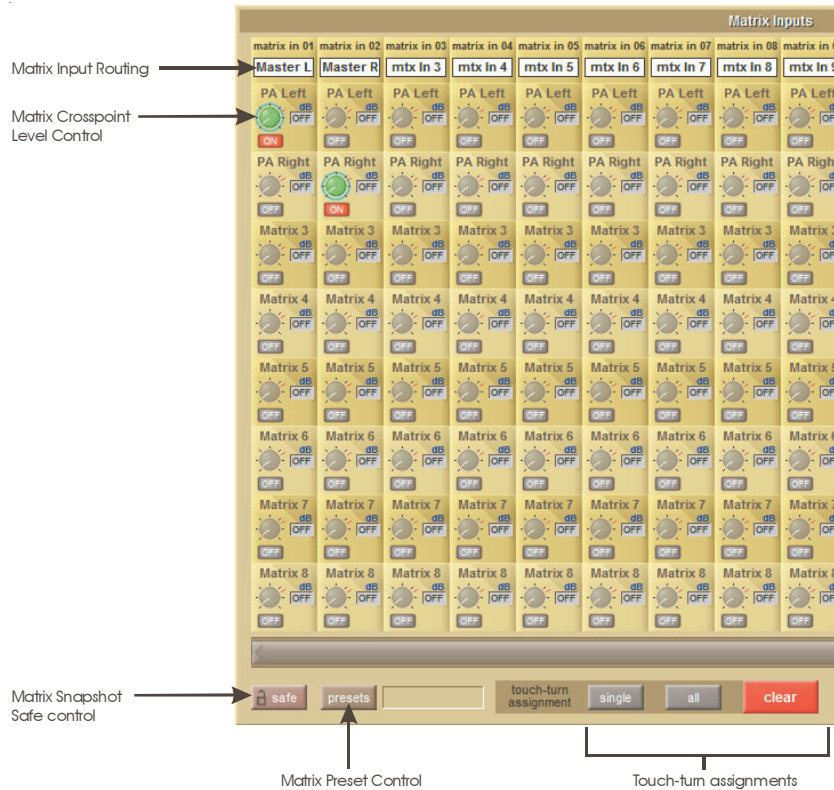

The top of each input column displays the input's name, and the label above each trim pot displays the pot's output. Touching any trim pot assigns it to the **Touch-Turn** encoder; pots lighten and are ringed green to indicate that they have been assigned. Multiple pots can be assigned simultaneously, in which case the encoder alters all assigned pots by the same amount, regardless of each pot's position. The value of each pot is displayed in dB to its right. Sends are switched on using the Touch Turn control's button; the display shows **OFF** in grey when it is off, and **ON** in red when switched on. Turning a pot automatically switches it on.

There are three **touch-turn assignment** buttons at the bottom of the display. The **all** button assigns all the trim pots to the **Touch-Turn** encoder; individual pots can then be deselected by touching them. The **clear** button clears all the pots from the touch-turn encoder. Activating the **single** button prevents multiple trim pots from being assigned to the encoder simultaneously.

**Note that the all function can still be triggered when the single function is active.**

## Chapter 2 - The Master Screen

Matrix input signals are selected in the **Setup** display, accessed by touching the text box at the top of each matrix input column. At the top of the **Setup** display, there is a text box which can be used for renaming the matrix input. Below that, there is a matrix input routing button which opens up a routing display. Routing displays are described in the Getting Started Section.

Below the routing button, there is a scrollable list of buttons displaying the names of all the other matrix inputs, under the heading **copy settings from**, used to copy matrix settings between input columns. To copy the level and on/off status of each send from one column to another, simply touch the button for the input column from which you want to copy settings.

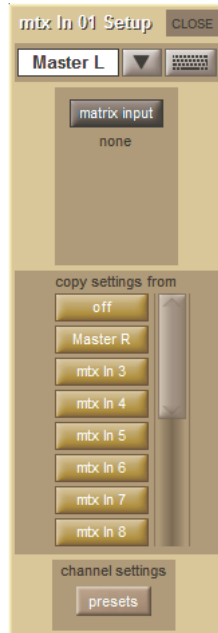

The **Matrix Input Presets** panel is opened using the **presets** button located at the bottom of a matrix input **Setup** display and also at the bottom of the **Matrix** panel. Preset panels are described in full in the Getting Started section. To include input routes in the preset recall, make sure the **input** button at the base of the screen is active. To include trim pot levels and on/off buttons, make sure the **sends** button at the base of the screen is active. The **chs** column of the display indicates the number of channels included in the preset, and presets can be named – by default, Presets are named after input signal 1.



The **safe** button at the bottom of the **Matrix** panel protects the matrix settings from being overwritten by a snapshot recall.

## 2.8 Graphic EQs Menu

### 2.8.1 Graphic EQ Panel .....

Touching the **Graphic EQs** menu opens a display of the console's graphic EQs. This display allows all of the available 32-band graphic EQ's to be configured. Graphic EQ's can be assigned to the inserts and outputs of all four channel types, and can also feed the input of an input channel. Graphic EQ routing is done via the channel routing pages, and is not accessible from the master **Graphic EQs** display.

The display consists of miniature representations of all available graphic EQ's, one of which is also shown expanded in the bottom of the display:

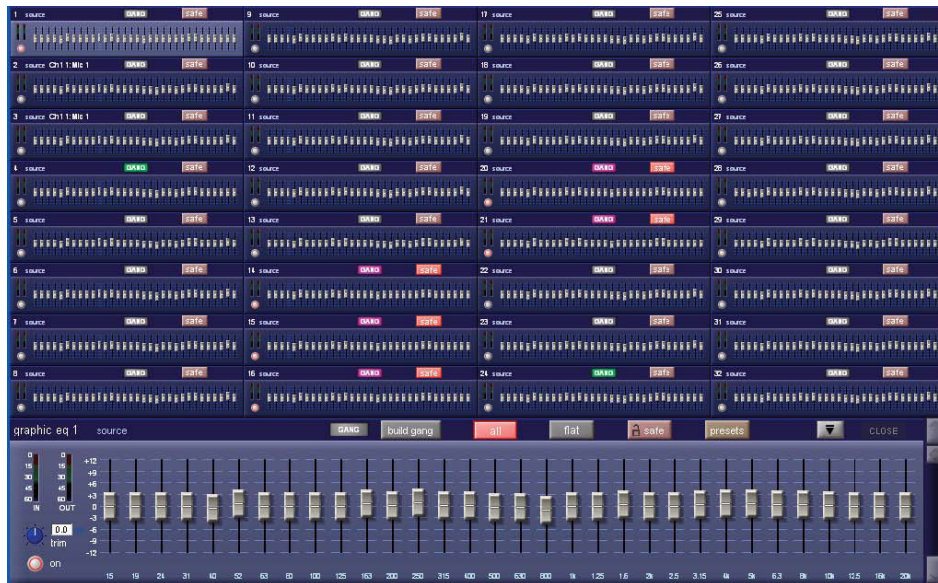

The settings on each graphic EQ are accessed via the expanded display, though some settings can also be adjusted in the miniature display. Touch any of the graphic EQs to assign it to the expanded display. The EQ assigned to the expanded display can also be scrolled using the scroll bar to the right of the expanded display. The EQ currently assigned to the expanded display is indicated in the top left-hand corner of the expanded display, along with indication of the EQ's **source**. The miniature display can be opened and closed by pressing the expand button (a down-arrow when opened, and an up-arrow when closed) to the left of the expanded EQ **close** button.

The left-hand side of the expanded display includes metering of the EQ's **IN** and **OUT** signals, a  $\pm 18$ dB gain **trim** pot with value indication to its right, and an **on** button which is ringed red to indicate that the EQ is on. Touch the **trim** pot to assign it to the Touch-Turn encoder. To the right of these controls, the 32 EQ band faders are displayed. The label located beneath each fader indicates the frequency of each band in Hertz, and the gain scale associated with each line on the display is indicated to the left of the lowest band. Each band can also be altered within the miniature display.

### 2.8.2 Ganging Graphic EQs .....

The grey **GANG** and **build gang** buttons above the band faders are used for ganging together different graphic EQ's. When EQs are ganged, their band faders, **on** buttons and trim pots are locked together.

**Note that ganging of faders is relative: EQs can have different shapes when they are ganged, and each EQ will move by the same amount when a band is adjusted.**

**Note that if faders are moved within the miniature display, any other EQs ganged to them will also move.**

When a set of Graphic EQs are inserted on a stereo or surround channel, those EQ units are automatically ganged together, and are then automatically unganged when the insert route is removed.

**Note that it is the Insert Return routing, not the Insert Send routing, which gangs EQ units.**

To start building a gang manually, touch one of the graphic EQs to be included in the gang to assign it to the expanded display, and touch **build gang**. The button turns red to indicate that it is active. The **GANG** button to its left will also become coloured, indicating that it is included in the gang being built. To add further EQs to the gang, touch the relevant small Graphic EQ display on the other Graphic EQs to be included, and they will change colour to match the expanded EQ's **GANG** button. To deselect any EQs from the gang, touch their **GANG** buttons again and they will return to grey. Touch the **build gang** button to complete the ganging process. EQ gang assignments can be adjusted by reselecting the **build gang** button.

**Note - To temporarily isolate a Graphic EQ band from a gang, press and hold the mute button above the band's fader and then make the adjustment to that fader - this move will only be made to that band on the Graphic EQ that you are currently adjusting.**

## Chapter 2 - The Master Screen

---

### 2.8.3 Graphic EQ ALL Button .....

To adjust all graphic EQs at once, select the **all** button to the right of the **build gang** button. It turns red to indicate that it is active. Adjusting any band in the expanded EQ will cause that band in all EQs to jump to that position.

*Note that the all function is absolute: Once a band is altered, any variations on that band between the EQs is eliminated.*

*Note also that the all function does not affect the normal operation of faders in the miniature display - they still operate independently.*

To return all 32 bands within one EQ to 0dB, touch the **flat** button to the right of the **all** button, and touch **Yes** in the confirmation pop-up which appears.

*Note that the flat function affects any EQs which are ganged to the expanded EQ.*

Activating the **safe** button, to the right of the **flat** button, protects the graphic EQ settings from being overwritten by a snapshot recall.

### 2.8.4 Graphic EQ Presets .....

Touching the **preset** button, to the right of the **safe** button, opens the **Graphic EQ Presets** display in which current settings can be saved and pre-created settings imported.

The positions of the **trim** pot, **on** button and all 32 faders are included in an EQ preset. To reset the channel to the default settings, press **default**.



## 2.9 Control Groups

### 2.9.1 The Master Control Groups Display .....

An overview of all the Control Groups within a session can be accessed via the **Control Groups** menu button in the master panel.

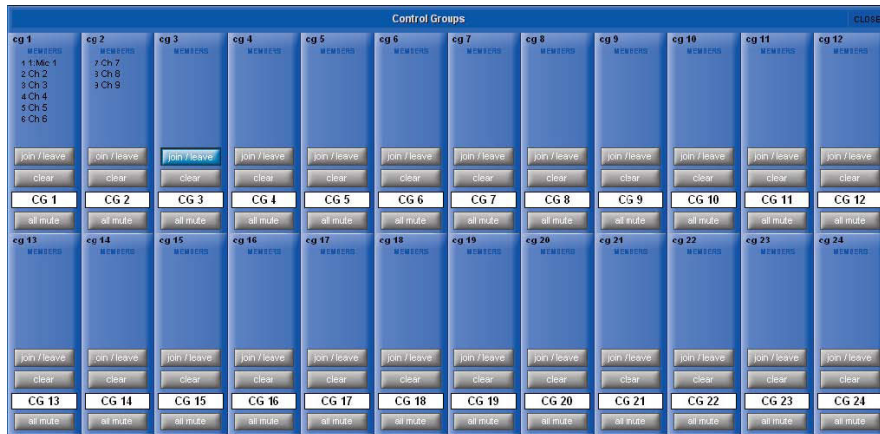

This display consists of basic versions of each Control Group channel strip, including the channel assignments lists and a number of basic settings which can also be adjusted in the display: **join/leave**, **clear** and **all mute**. The Control Group naming controls are also available within the display's channel strips.

Any number of input channels and output channels can be connected to one or more of the Control Groups. They can then all be operated from a single worksurface control. Changes to the Control Group fader, mute or solo or controls will affect all channels connected to the group.

There are 2 methods to set up Control Groups:

- 1) Press the **LCD Function** button on the CG fader bank followed by the **JOIN CG** button; Press the channel select button for the CG that you want to use; Press the channel select buttons for each of the channels to be included in the CG; Deselect the **JOIN CG** button:

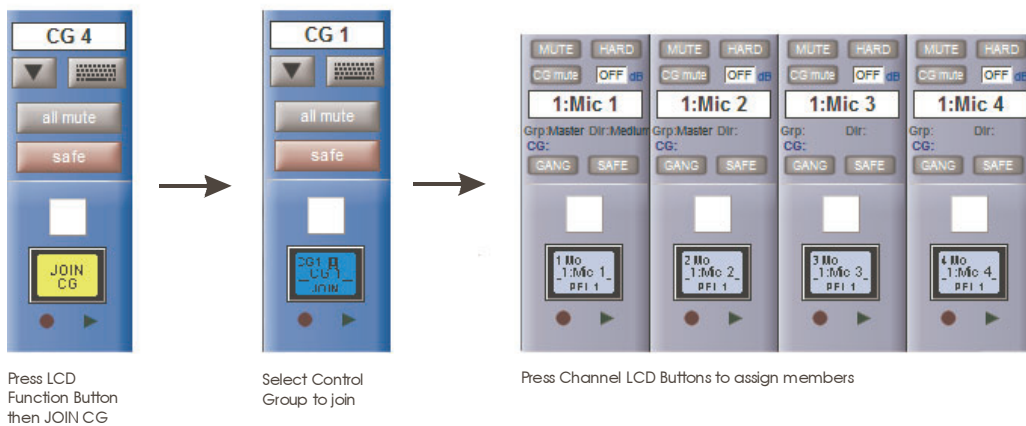

- 2) Press the on screen **JOIN/LEAVE** button for the required CG channel; Press the channel select buttons for each of the channels that you want to make members of the CG; Release the **JOIN/LEAVE** button:

# Chapter 2 - The Master Screen

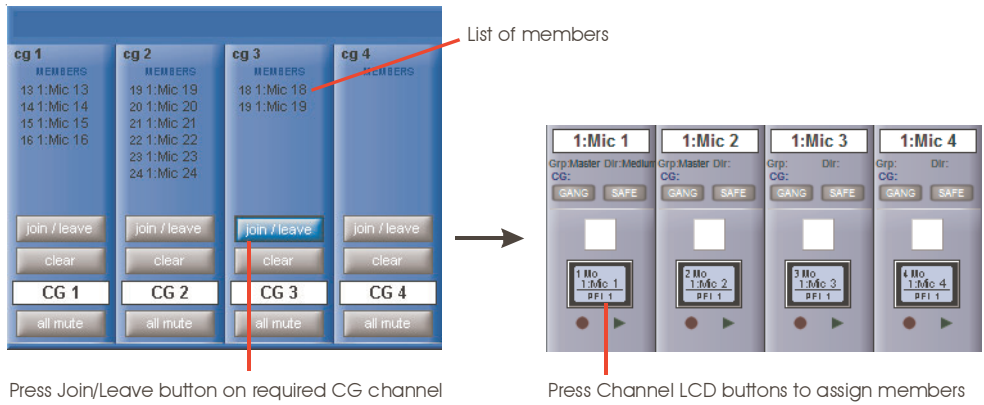

A list of all the connected channels and their names is displayed above each Control Group display.

You can also clear all the channels from a Control Group by pressing **Clear**.

When a channel is a member of a Control Group, its own controls can still be adjusted independently of the other Group members. Adjustments to fader levels are transmitted to the Group members as dB changes, so that a level increase of 2dB on the Group fader will increase all the member levels by 2dB, irrespective of the relative levels of the individual channel faders.

### Control Group Channel Strips

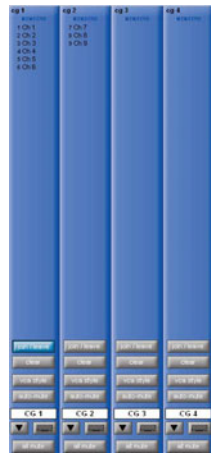

**Note that Control Group channels function completely differently from Group channels: Group channels mix together the audio from any channels routed to them, whereas Control Group channels simply move the channel faders of any channels assigned to them, irrespective of any audio routing.**

The number of control groups available is defined in the console **Session Structure**. Control Groups can be named using the standard naming tools. The **safe** button, located at the bottom of the on-screen channel strip, can be used to protect the assignments and settings of the Control Group from being changed if a new Snapshot is fired.

All of the Control Groups to which an input or output channel belongs to are displayed immediately above the **GANG** and **SAFE** buttons in the Channel strip panel.

**Note that only the first two to three Control Group assignments within a channel can be displayed in the channel strip.**

All of the channels included in a Control Group are listed in the top half of the Control Group channel strip display.

To clear all of the channels currently assigned to a Control Group, touch the Control Group's **clear** button, located below the **join/leave** button, and press **Yes** in the warning display that appears.

### 2.9.2 Control Group Fader Modes .....

There are three modes in which the Control Group fader can interact with the faders of the channels assigned to it, and the button below the **clear** button in the channel strip display toggles between them:

In **moving fader** mode, all assigned faders will move to replicate any Control Group fader movements.

**Note that it is the level change associated with the fader movement which is replicated, not the physical distance the fader is moved.**

In **vca style** mode, moving the Control Group fader affects the output level of all assigned channels without moving their faders.

In **mute only** mode, the Control Group only controls the mute buttons of assigned channels, not the output level.

**Note that in all three modes, moving the fader of a channel assigned to a group does not impact the output levels of other channels within the group.**

## 2.9.3 Control Group Mute Functions .....

The mute buttons within a Control Group interact in the same way, regardless of the current fader mode:

The mute button above the LCD display on a Control Group fader can be used to mute all of its assigned channels. Its function is duplicated by the **all mute** button below the channel's scribble strip. When a channel is muted by its Control Group mute button, the channel's mute button lights in the normal way. The channel's **CG mute** button goes blue to indicate that the Control Group mute button (rather than the channel mute button) is responsible for the mute. When deactivated, the Control Group mute button returns all assigned channels to their mute state before the Control Group mute button was activated.

CG Mutes are treated as "in series" where a channel is a member of more than one group. All CG mutes must be off for a channel to be unmuted; any CG muted always mutes all of its members.

If a channel is CG muted by single or multiple CGs, the worksurface channel mute button will override all CG mutes for that channel. The channel will not however be removed from CG membership so if the relevant CG is muted again, the channel will also be muted.

The auto-mute function, activated by touching the **auto-mute** button located above the Control Group name in the Channel Strip panel, automatically mutes any channel which is removed from that Control Group and unmutes any channel that joins the Control Group.

## 2.10 Solos Menu

### 2.10.1 The Solo Panel .....

Touching the **Solos** menu opens the **Solo 1** and **Solo 2** displays. These displays are used for configuring the console's solo busses. Solo buss 1 is configured in the left-hand display, and solo buss 2 in the right. Both displays function in exactly the same way:

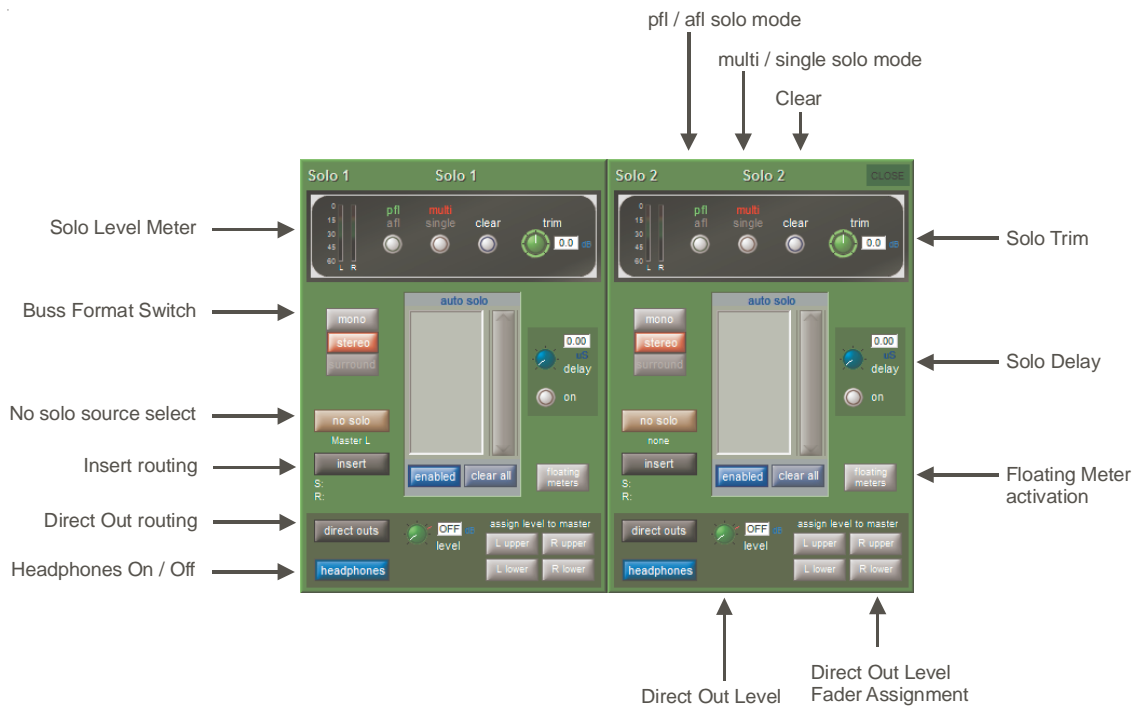

**The SD7 Solo panel**

**Note that the in-channel solo functions are described in the Channel Types Chapter**

At the top of each display is a black box containing the solo meter(s), three buttons, and an input trim pot. These controls are duplicated on the console worksurface,

# Chapter 2 - The Master Screen

The first button selects which point in the channel feeds the buss, and toggles between PFL and AFL, as indicated by the **pfl** or **afl** labelling above the button turning green. The button is also ringed green on the worksurface when **afl** is selected.

The second button toggles the two solo button modes: **multi** in which multiple channels can feed the solo buss at once, or **single** in which only one channel can feed the buss. In **single** mode, when a channel is feeding the solo buss, pressing the solo button on a different channel will cause the originally selected channel to be deselected from the solo buss. The solo button mode is indicated by the **multi** or **single** labelling above the button turning red. The button is also ringed red on the worksurface when **single** is selected.

All feeds to the solo buss can also be cleared by pressing the **clear** button. When there is a feed to that solo buss somewhere on the console, the button is ringed blue on the worksurface.

The level of the solo buss can be adjusted using the trim encoder on the worksurface. The on-screen **trim** pot is always assigned to this worksurface encoder, as indicated by the presence of green ring around it. The signal can be trimmed by  $\pm 18\text{dB}$ , and the trim value is indicated to the right of the on-screen **trim** pot.

In the centre of the **Solo 1** or **Solo 2** display, there is an **auto solo** area which lists all the channels which are selected for the **auto solo** function. This function automatically routes selected channels to that solo bus whenever another channel is soloed, and the selected channels can be scrolled if necessary using the scroll bar on the right of the list. The **auto solo** channels are selected in the Channel Setup display. This **auto solo** function is enabled and disabled by touching the left-hand blue button below the **auto solo** list. The button label displays whether the **auto solo** function is **enabled** or **disabled**. The channels in the **auto solo** list can all be removed by touching the clear all button below the **auto solo** list.

*Tip: If you are using effects returns, selecting auto solo will allow soloed tracks to be auditioned with their effects returns - this function only works in Multi-Solo mode.*

The solo buss signal can be delayed using the **delay** pot to the right of the **auto solo** area. Switch the delay on using the **on** button below the pot. Touch the pot to assign it to the Touch-Turn encoder. The delay value has a range of 0 to 2.7 seconds and is displayed above and to the right of the **delay** pot.

The **mono**, **stereo** and **surround** buttons to the left of the **auto solo** area select the size of the solo buss. Each button is red when selected and grey when not selected. The selected format is also indicated by the number of meters displayed in the top-left corner of each display.

## 2.10.2 The No Solo Setup Display .....

Below the **mono**, **stereo** and **surround** buttons, is a button marked **no solo**. This button defines what signal (if any) is present on the buss when no channel solo is active. By default, there is no signal feeding the buss when no channel solo is active. Pressing this button opens the **No Solo Setup** display:



At the top of the display, there is a text box which can be used for renaming the solo buss. Touch the box or the keyboard symbol to its right, type the new name on the on-screen or external keyboard and press **OK**. The **Channel Name** display containing commonly used words for quick insertion can be accessed for buss naming by touching the down arrow immediately to the right of the text box. The solo buss name will then appear at the top of its master solo display, and in any solo-assigned master faders (See below for details).

Below the naming area, there are two columns of buttons used for selecting the audio source for the **no solo** function from among the group and aux channels. The left-hand column contains two pairs of buttons: the **groups** buttons (**mono** or **stereo**) and the **auxes** buttons (**mono** or **stereo**). Touching one of these buttons causes it to lighten to indicate that it is selected, and results in a list of those channels appearing in the right-hand column. A scroll bar appears in the right of the display if the channel list is too long for the window.

Touching one of these signal buttons assigns it to the **no solo** function, as indicated by the lightening of the signal's button and by the labelling immediately beneath the **no solo** button displaying the signal name. If a stereo signal is selected here, only the left-hand signal is displayed beneath the button. Signals can be deselected by touching them again. When no signal is selected for the **no solo** function, the labelling beneath the button displays **none**.

To close the **No Solo Setup** display, press the **CLOSE** button in the top right-hand corner.

The area below the **auto solo** area concerns the solo buss outputs. In the centre of the output area, there is an output level pot. Touch the pot to assign it to the Touch-Turn encoder. The buss output level trim ranges from **OFF** to +10dB, as indicated to the right of the pot.

### 2.10.3 Assigning Solo Busses to Faders .....

The solo buss output level can also be assigned to the master fader(s) by pressing the **assign level to master** button(s) to the right of the **level** pot. Each button is highlighted in gold when it is selected. When a solo buss is assigned to a master fader, the master fader LCD button displays green, and the button lightens to indicate when any channels are assigned to the solo buss.

The top half of the LCD buttons displays the solo buss number along with any name given to it in the **No Solo Setup** display. When the fader is moved, the bottom half of the LCD button displays the fader level.

When a solo buss is assigned to a master fader, the fader's LCD button becomes a solo clear button, as indicated by **CLEAR** being displayed in the bottom half of the button when the fader is stationary.

Solo Busses can also be assigned to channel faders by using the **LCD Function>assign faders** and selecting the solo channels from the **channel list**.

### 2.10.4 Solo Outputs Routing .....

Each solo buss includes an insert send and return, and a direct output, both of which are routed in the **Solo Outputs** display. This display is accessed by touching the **insert** button below the **no solo** button, or the **direct outs** button in the top left of the solo buss output area.

This insert point only applies to the Solo buss Direct Output, not to the headphone signal.

At the top of the **Solo Outputs** display, the buss naming function described above is duplicated. Towards the bottom of the display, there are two buttons marked **output** and **insert A**. Selecting one of these buttons assigns that send (or send and return) to the signal routing area above it: When the insert is assigned, the **ins A send** routing button appears in the left-hand column, and the **ins A return** routing button in the right-hand column; When the output is assigned, the **outputs** routing button appears in the left-hand column and the right-hand column is left blank. Pressing any of these routing buttons opens a routing display. Insert and output routing can then be routed as described in the Getting Started section.

An extra button labelled **send+return** is included above the **ports** list in the **Insert Send Route** display button. When this button is activated, the send and return routing is linked for all signals within the **INTERNAL** port: If the **Graphic 1** input is assigned to the insert send, the **Graphic 1** output is automatically assigned to that insert return. Similarly, if it is the return which is manually assigned, the send automatically copies that send assignment. The **send+return** button is grey when inactive and brown when active.

Once the insert send and return signals have been selected, level trim pots appear in the bottom half of the **Solo Outputs** display. To the left of both pots there is a meter (or pair of meters, in the case of stereo channels) displaying the send or return level, and to the right of both pots there is a numeric display of the level trim in dB. Below the send level trim there is an **on** button which switches the send on and off. Below the return level trim there is a reverse phase button which inverts the phase of the returning signal. Both of these buttons become ringed in red to indicate that they are on.

Once any insert or direct out has been routed, the route is displayed below the button in the **Solo 1** or **Solo 2** display.

### 2.10.5 Headphone Outputs .....

Touching the **headphone** button in the bottom left-hand corner of the display sends the solo buss signal to the headphone socket(s), located under the arm rest. The button turns blue to indicate that it is active.

The headphone output(s) receive both solo buss signals, and the headphones will be silent when neither buss is routed to them, unless a **no solo** signal has been assigned.

The headphone level is controlled by the output **level** pot in the output area, and also by the headphone level encoder located on the surface. The headphone signal can be muted by pressing the **mute** button next to the worksurface headphone level encoder, and the button is ringed red to indicate that the headphone send is muted.

### 2.10.6 Solo Meters .....

Solo meters can be displayed on the Master or Overview screen by pressing the **floating meters** button below the solo **delay** area in either side of the **Solo** panel.

*Floating meters are described in the Channel List section of this chapter.*

### 2.10.7 Solo As an Input Source .....

**Function only available on a Default Session created in SD V680+**

Both Solo 1 and Solo 2 are available as input sources for all channel types. A warning confirmation will appear on screen before the route is made.

**WARNING: Soloing a channel that has a solo buss as its source will result in a feedback loop being created and dangerously high audio levels at any output routed from the solo buss or channel**

# Chapter 2 - The Master Screen

## 2.11 Network and Mirroring

### 2.11.1 Network Configuration .....

Any two SD Series consoles of the same type can be mirrored together to provide a fully redundant audio system. The SD7 console is fitted with two separate engines, and as such, offers built in redundancy.

In order to take advantage of this redundancy, you need to verify the console networking is working, and synchronise your session between the two consoles/engines.

Before the consoles/engines can be mirrored, you should ensure that a standard crossover network (Ethernet) cable is connected between the two consoles/engines. Without this connection, the two consoles/engines will not "talk" to each other.

To open the Network window, touch the **Network** button at the top of the Master Screen. The following window will open...

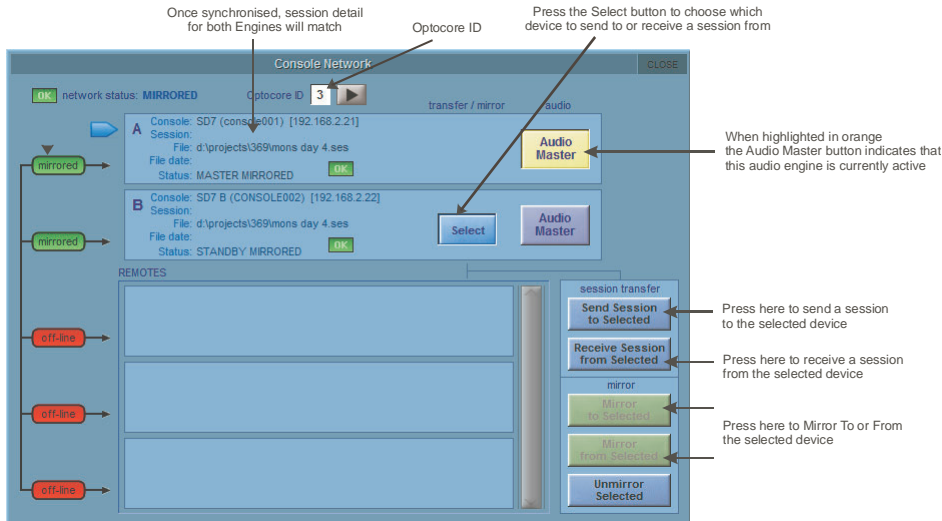

### 2.11.2 Mirroring for the first time .....

If the consoles are connected together, but do not see each other, then you may need to enable Networking.

There is an option in the **OPTIONS/SESSION** tab to **ENABLE CONSOLE NETWORK** (YES/NO). This must be set to YES on both Engines. After doing this, shutdown and restart both consoles/engines and when the sessions are loaded go to the **NETWORK** window and you should see yellow OK lights against A & B. This indicates that the network has connected the two consoles/engines but they are not yet mirrored.

In order to mirror the two consoles/engines, they need to be running the same session. The way to achieve this is to load the session into the A console/engine, then transfer it to the B console/engine using this Network window.

1. Ensure you are switched to the A console/engine.
2. Load your session into console/engine A
3. Open the Network Window
4. Press the **Select** button for console/engine B and then press the **Send Session To Selected** button.

This will copy your current console/engine A session and load it into the B console/engine. Once this is done, the console/engine B detail section will change to reflect the new loaded session.

You can now press the **Mirror** button. The Mirror buttons will turn green, and the console is now mirrored. Audio Mastership can be switched between console/engine A and console/engine B using the **Audio Master** button and, assuming that the racks are correctly connected, you will not hear the switch of between the two engines.

There is also an option to **Receive Session From Selected** which allows a session file to be brought into one engine from another.

When the **Mirror From Selected** or **Mirror To Selected** buttons are pressed, the current worksurface mix settings like fader positions are transferred from one device to another. If you have sent or received a session and then made some simple changes, the additional adjustments are normally transferred when you activate the Mirror mode. If there is a significant difference between the two devices' settings at that point, you will be prompted to resync the session.

On an SD7, the ENGINE A/B switch at the top of the centre worksurface will switch the entire worksurface from one engine's control computer to another. It will not (by default) switch the audio processing from one engine to the other. This is achieved by pressing the relevant **Audio Master** button in the network window on either engine. When the button is orange, the engine is active.

There is an option in **OPTIONS/SURFACE** tab that enables the switching of both control computer and audio mastership at the same time with the worksurface ENGINE A/B switch. When first configuring the system, we do not recommend running in this mode

## 2.11.3 Mirroring Mode .....

This option determines how the console will behave when Mirrored via a network to another console, engine or Offline PC. This option is saved for console not in the individual session.

There are 4 modes of operation.

**Full Mirror** - all functions mirrored from one device to the other - this mode should be used on both engines in an SD7.

**Expander** - intended for use with an SD7 console and an EX007 Expander unit. The second device mirrors most functions from the first device but significantly, allows different banks to be selected on the different devices.

**Remote** - intended for use with a PC being used as a Remote Control for a console. Allows different banks to be selected and different setup options on each device.

**One Way** - this mode is intended for remote monitoring of what another device is doing. If a device is in One Way Mirror mode, it can "see" what the other mirrored device is doing but cannot control the other device. This mode is only likely to be used in exceptional circumstances.

When mirroring 2 single engine consoles, the correct mirroring mode will depend on the operational requirements of the system.



## 2.11.4 Mirroring with a laptop PC .....

An SD Series console can also be connected to a laptop PC running the Windows operating system in similar way to achieve remote control of the console.

When running SD software on a PC, the software will appear in a number of "floating" windows, each of which represent a console section. A screen touch on the console is simulated by a right click with the PC mouse. To switch between console sections use the small toolbar buttons that also appear on the screen marked Master\Left\Right.

The DiGiCo website has downloads available for all current versions of "Offline" software.

The SD software on the PC is identical in operation to the console software and the USB key that is provided with the console will contain the SD offline software installation package.

Run the Installer from the USB Key. It will create folders in the root directory of your PC's C:\ drive and place a shortcut to for the Offline Software on the desktop.

**IMPORTANT NOTE - When mirroring a console to a PC you are required to set a static IP address on your PC which is in the same subnet as the console itself. The console's subnet mask is 255.255.0.0 255.255.255.0 (SD7 only) and its IP address can be seen next to its entry in the Network panel - in the picture above it is 192.168.2.84 for Engine A.**

**The IP address of the PC must start with 192.168.2.xxx. and must be different to that of the console.**

**The setup of network addresses on a PC may differ from one operating system to another so if you are in doubt, please consult the documentation for your PC's operating system before proceeding.**

As an example, on Windows XP, the IP address and subnet mask can be changed by:

- 1) Opening the **Control Panel>Network Connections**.
- 2) Right clicking on the **Local Area Connection** and selecting **Properties**.
- 3) Double Click on **Internet Protocol (TCP/IP)** from the list to show its **Properties**.
- 4) Set the radio button to **Use the following IP address**
- 5) Type the **IP Address** and **Subnet Mask** as detailed above
- 6) Confirm the changes and restart the computer

# Chapter 2 - The Master Screen

## 2.13 Setup Menu

APPENDIX A of this manual contains further details about Optocore connected systems

### 2.13.1 Audio I/O .....

The **Audio I/O** display is used to configure the physical I/O connected to the SD Console, including identifying and naming the sockets of the option cards installed in racks, and the setting of pads and phantom power.

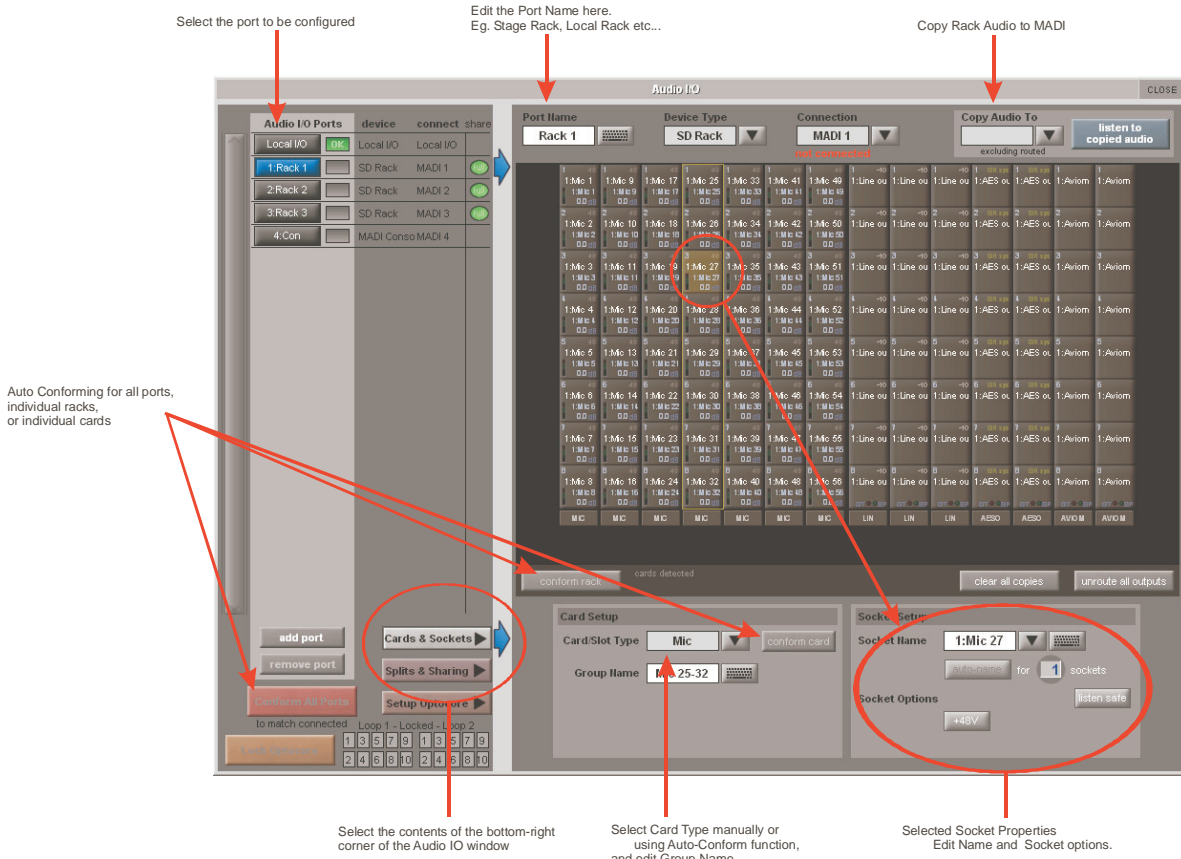

### 2.13.2 Port Selection .....

The **ports** buttons in the top left-hand corner of the display select which port is being configured in the rest of the display. Each port relates to a set of physical audio connections:

- Local I/O** The I/O installed in the rear of the console
- Rack** A remote I/O rack connected via MADI or Optocore
- Con** A separate console connected using MADI or Optocore,

Once a port has been selected, the connections contained within it are displayed in the Sockets graphic which makes up the most of the rest of the **Audio IO** display.

The box to the right of each port selection button displays the current state of the connection:

New optocore ports can be added to the **ports** selection area by pressing the **add port** button, below the **Connection** box. User-created ports can also be deleted by pressing the **remove port** button, below the **add port** button.

#### Copying Audio and Listening to Copied Audio (MADI Recorder Setup)

Any incoming MADI or Optocore connected rack stream can be copied to any other MADI Output by selecting the incoming Port in the Ports list and using the **Copy Audio To** drop down menu. For example, if you want to copy Rack 1's Audio Inputs to a MADI equipped recorder connected on Port 2, select Port 1 in the ports list and then select MADI 2 from the **Copy Audio To** drop down menu.

The console will send the 56 or 64 channel MADI stream to MADI Output 2 and it can be recorded as necessary.

In addition, by connecting the recorder's MADI Output to the console's MADI 2 Input, the playback can be monitored in the same channels as the original source material. Just press the **Listen To Copied Audio** button to monitor playback and press it again to return to monitoring the live sources from the rack.

When Listen to Copied Audio is active, "Listening to Copied Audio" is displayed in the session status panel of the master screen.

More complex inter port routing is possible using the Copy Audio Panel. Please see the COPY AUDIO section of this manual.



**2.13.3 Port Hardware Configuration .....**

The port is named automatically according to its connection type, as displayed to the right of the **ports** selection area. However, the name can be edited by touching the **Port Name** box or the keyboard symbol to its right, typing the new name into the QWERTY keyboard which appears, and pressing **OK**. The type of device connected to the port can be altered by touching the down arrow next to the **Device Type** box, located next to the **Port Name** box, and selecting the appropriate device from the drop-down list that appears. The physical port being used to connect the device can be altered by touching the down arrow next to the **Connection** box, to the right of the **Device Type** box, and selecting the appropriate connection port from the drop-down list that appears. The current status of the connection is displayed below the **Connection** box as either **connected** (in green) or **not connected** (in red).

*Note that the configuration of the Local I/O port is fixed, so no hardware changes are possible. You can, however, change the Port Name, the Group Names (relating to name of each physical card) and the Socket Names (the name of each physical connector on a card).*

**2.13.4 Port Control .....**

Normally, the input gain, phantom power and pad of each DiGiCo Rack input is controlled remotely from the SD Console. However, in multi-console systems where Racks are shared between two DiGiCo consoles with MADi Connections, only one of the consoles can remotely control these rack settings. With Optocore connections any console can have control. Therefore, the level of control given to each console must be defined. Control options are displayed in the bottom-right area of the **Audio I/O** panel when the **Splits & Sharing** button towards the base of the panel is pressed:



There are three levels of control:

**isolate:** The SD Console will not exchange any control data with the rack. This means that the console will neither be able to adjust rack settings, nor adjust its own settings according to returning control data.

**receive only:** The SD Console will receive the rack's existing settings but not send control data back. This means that the console will not be able to adjust rack settings, but will be able to adjust its own settings according to returning control data.

**full control:** The SD Console will receive the rack's existing settings and will send control data back. This means that the console will be able to adjust the rack's settings and receive tallies back from the rack.

When the **Rack** port is selected in the main panel, its control can be defined as shared by pressing the **Shared** button. Individual racks can also be controlled using the **isolate**, **receive only** and **full control** buttons beneath the Shared button - these buttons will only affect the selected port.

**2.13.5 The Socket Display .....**

When a port has been selected from the **ports** list on the left, the individual connections within that port are displayed in the Sockets graphic, which makes up most of the rest of the **Audio IO** display. For Rack or Console ports, each column in the graphic represents an IO card, and the type of IO card is displayed at the bottom of each column. For the **Local I/O** port, each row represents a type of I/O socket.

Each individual socket displays the following information: the current socket name is across the middle, and the socket number within the card is in the top left-hand corner.

For analogue input sockets, the current gain is at the bottom, and the top right-hand corner displays a red **48** symbol if the socket's phantom power is switched on.

For analogue rack output sockets, there is a **-10** symbol in the top right-hand corner which is yellow to indicate that the 10dB pad is switched in, and white to indicate that no pad is present.

For digital inputs the status of Sample Rate Conversion On/Off is displayed.

Touching a socket within the graphic assigns that socket and its card to the area below the graphic for configuration, as described below.

The number in the top left corner of an output socket will change colour if the socket is being used by the Copy Audio Function.

**2.13.6 Socket Conforming .....**

In order to use the rack, the on-screen contents of the rack must match the cards physically installed in the connected rack. There are two ways of achieving this:

**Manual Conforming**

Select each card (column) and manually select the appropriate card in the **Card/Slot Type** drop down menu in the lower section of the window. Once the correct card type is selected, the card type name at the bottom the selected card will turn green,

# Chapter 2 - The Master Screen

indicating the card type matches the card installed in the rack. If there is a mismatch, the card type name will be red, and the error should be corrected by selecting the correct card type.

### Automatic Conforming

The audio I/O can be automatically conformed for the whole console (using the **Conform All Ports** button in the bottom left of the panel) or the currently selected rack (using the **conform rack** button below the socket display). Pressing these buttons will correctly select the correct card for each slot. Once complete, all of the card labels beneath each slot should turn green.

It is also possible to auto-conform on a card-by-card basis: With a single card selected (by touching any of the sockets on that card), press the **Cards & Sockets** button towards the base of the screen, followed by the **conform card** button which appears in the area to its right.

### 2.13.7 Group and Socket Names .....

Cards and sockets are named automatically, according to the **Device Type**, **Card/Slot Type** and their position within the port. To edit these names, press the **Cards & Sockets** button towards the base of the **Audio I/O** panel to bring up the **Card Setup** and **Socket Setup** displays to its right:

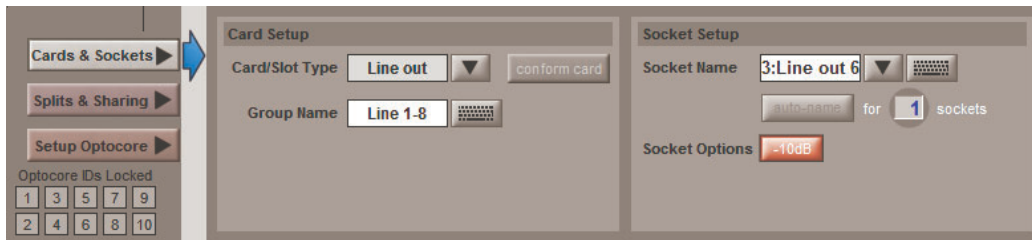

Touch either the **Group Name** or the **Socket Name** box (or the keyboard symbols to their right), type the new name into the QWERTY keyboard which appears and press **OK**. Touching the down arrow in between the **Socket Name** box and keyboard symbol opens up the **Channel Name** display which enables commonly used words to be inserted quickly without the use of the keyboard.

A range of sockets can be named with the same label and an incrementing number by using the **auto-name** function below the **Socket Name** box: To define how many sockets will be auto-named, touch the numeric display, turn the **Touch-Turn** encoder to the right of the screen until the numeric display below the keyboard symbol displays the correct number. Alternatively, touch the numeric display, type in the number of sockets to auto-name into the keypad that appears, and press **OK**. Once the number of sockets has been defined, the auto-name button becomes active. Pressing it will cause the name of the assigned socket to be replicated for all the sockets selected for auto-naming. If the assigned socket's name does not end in a number, a '1' will be added to it and incremented for the remaining sockets. If the assigned socket's name already ends in a number, that number will be incremented for the remaining sockets.

### 2.13.8 Socket Options .....

Depending on the socket type, further **Socket Options** are displayed below the **Socket Name** area.

**2.13.9 Copy Audio .....**

The Copy Audio Matrix, located in the Setup Menu, has been designed to serve 2 purposes:-

1. To provide a flexible system for routing input sources from multiple racks to a recording system.
2. To route inputs from one rack to the outputs of another rack without using up console processing resources.

Any input socket connected to a console port can be copied multiple times to any output port socket. One of these "copies" can be nominated as your "Listen Source" for when **Listen to Copied Audio** is activated.

It is also possible to place a copied input socket in "**Listen Safe**" so that when **Listen to Copy Audio** is activated, the original source will be heard rather than the copy source.

Copy Audio settings are not snapshottable and remain constant throughout a session unless they are manually changed by the user.

**Setting up the system**

In Audio IO, conform all your ports, make any required Optocore output allocations and map your system.

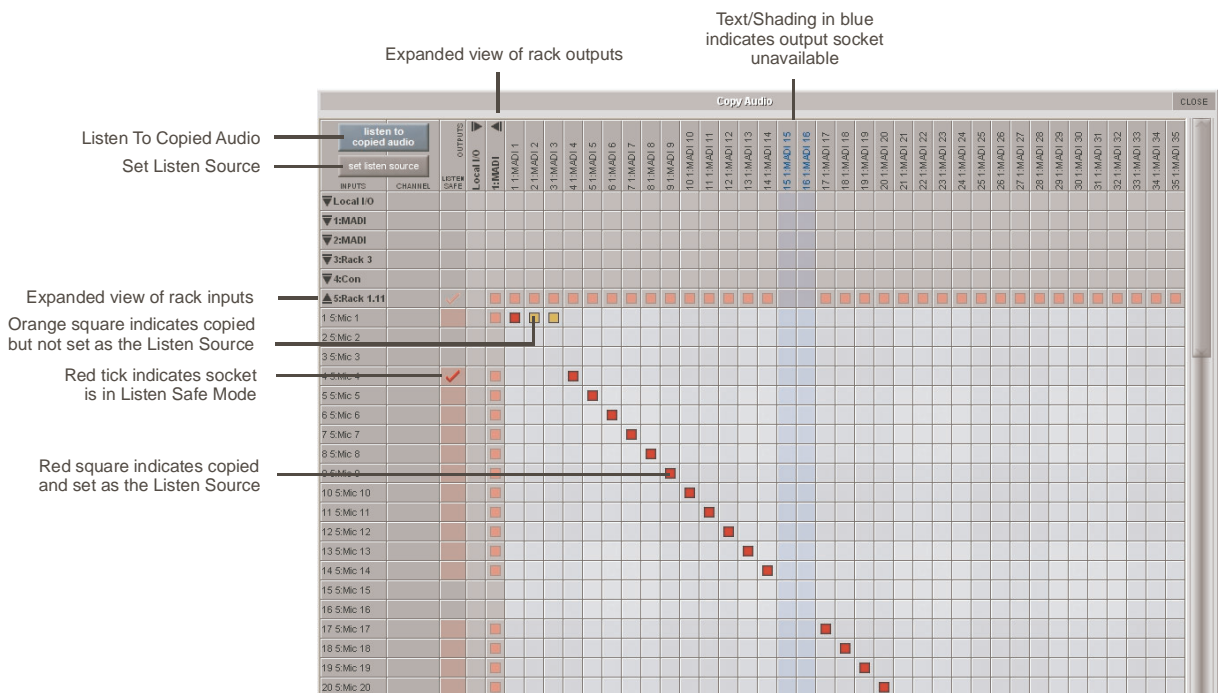

Open the Master Screen / Setup / Copy Audio panel and you will see the collapsed matrix with input ports listed down the left side and output ports across the top.

The input port list on the left shows all available input ports that have been configured in Audio IO including Local IO, MADI and Optocore connections. Touching on any of these ports will expand the list to show the individual sockets. If a socket has been routed into an input channel, the channel name will be shown in the "Channel" column.

The output port list across the top shows all available output ports that have been configured in Audio IO. When expanded, any output socket that is already in use or is not allocated to your console is shown in blue and its column highlighted. Existing routes from channels/busses cannot be overwritten in Copy Audio.

If a port is expanded, touching anywhere in the sockets list will collapse that port.

To make a copy route, expand an input port and output port and touch/drag on the grid. You will see the selected cells turn red. This first copy, by default, is defined as your **Listen Source**. Any subsequent copies of the same input socket are shown as orange cells. You may copy an input socket to as many locations as you wish but only one can be defined as your listen source. You can change the defined **Listen Source** by first pressing the "**Set Listen Source**" button in the top left corner of the panel and then touching on cell in the matrix. This cell will turn red and any previously selected listen source cell will turn orange.

If you have used the "**Copy Audio To**" function in the Audio IO Panel and the open the relevant ports in the Copy Audio panel, you will see a diagonal line of Red cells between the source port and the destination port.

If an output socket is being used as a copy destination, this will be indicated in the Audio IO page by card socket number showing red (for a Listen Source) or orange (for a copy). You will also see a red/orange square next to any sockets in use in any channel/ buss output routing panel. Please note the copy routes CAN be overwritten by output routes.

## Chapter 2 - The Master Screen

### Listen Safe

Listen safe is designed to allow the user to “Safe” a channel from the “Listen to Copied Audio” selection. This can be activated from the Copy Audio Panel, the Channel List (when in Edit mode) or any Input Channel Setup Panel. When active, the Input Channel Name box will turn red. As the Listen safe is associated with the input socket, Main and Alt inputs have independent listen safes.

### 2.13.10 Audio Sync .....

Selecting **Audio Sync** from the **Setup** menu opens the **Audio Sync** display. This is where the clock source is selected:

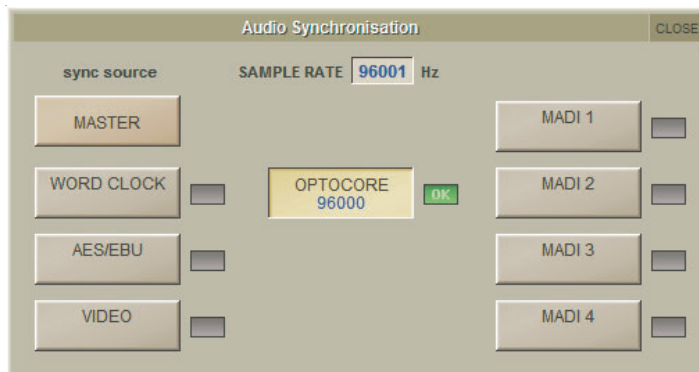

*The SD7 Audio Sync Panel*

An SD Console will operate at Sample Rates of either 48000Hz (48kHz) or 96000Hz (96kHz), as configured in the **Session Structure** panel.

By default, it is set to clock internally (Master) but the standard Audio Sync method is Optocore when the entire system uses the device with the lowest Optocore ID (usually ID1) as its sync source.

This setting is saved within the session file so if any console(s) are connected to racks with optical fibre then all console engines should be set to Optocore as their sync source.

There are also times when the console needs to be clocked externally. The Audio Sync panel allows you to control external synchronisation.

The console will clock from the following sources : Word Clock, AES/EBU, Video Reference (SD5, SD7), MADI & Optocore. In this situation one Optocore device should be set to clock to the external source and all other Optocore devices should be set to sync to Optocore.

**Note :** When a valid clock is detected on an external sync input, the corresponding Green OK box will light, even if that input is not selected as the clock source for the console.

### 2.13.11 Timecode & Transport .....

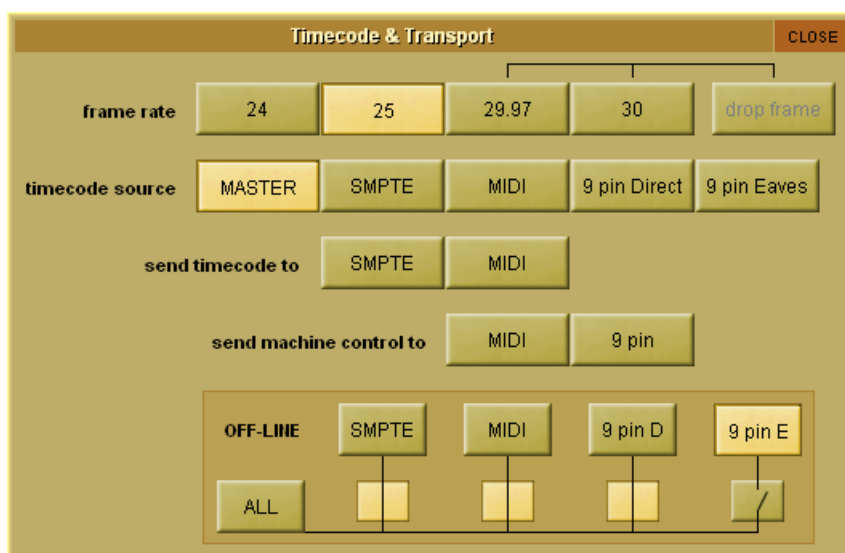

When the SD console is used in typical live sound applications there will be no time related control systems (timecode) or motion control (tape transport) connected. Synchronisation and machine control does not need to be considered.

This panel can be accessed by touching the **Setup** button on the Master screen and then touching the **Transport & Timecode** button.

**Frame Rate**

This must be set up for the frame rate used by your other equipment. You can select from four different basic frame rates, with a drop-frame option available for 29.97 and 30fps.

**Timecode Source**

You can choose the **Console** option to make the console generate the master timecode for the setup, or you can choose to make the console "chase" timecode which arrives at one of the external sockets - **SMPTE (LTC) (SD7 Only)**, **MIDI (MTC)**, or **9-pin**. These external sockets are located on the console rear panel.

The **9-pin Eavesdrop** option requires a special 9-pin cable . The option is provided for installations where the 9-pin connection runs between two other pieces of equipment (for example, a video machine and DAW), but the console is required to chase this timecode. 9-pin does not normally allow more than a single direct connection between two machines, but using the Eavesdrop cable, you can make the console "listen" to the timecode passing between two other machines, and to sync to and display this timecode on the worksurface.

*Note - if you are using 9-Pin Eavesdrop mode, you cannot use any of the options for direct 9-pin connection.*

**Timecode Output Enable**

Whether the console is operating as timecode master or deriving its timecode from another device, you can choose to route a timecode signal out from the MIDI (MTC) and/or SMPTE (LTC) sockets. If timecode is being received from another device it is regenerated before being routed to the output.

**Machine Control Enable**

The console can only send Control signals if you have enabled a Machine Control output. This can be MIDI Machine Control (MMC) and/or 9-pin Disk or Tape. Note that you cannot output 9-pin control if you are using the Eavesdrop option to read timecode.

**MIDI Machine Control** has limited transport features, supporting only the Play, Record, FF, Rewind, Stop and Locate functions. 9-pin control supports Shuttle and Jog functions.

**Off-line Buttons**

The configuration panel allows you to temporarily disable all timecode and transport control to any combination of outputs. The **ALL** button disables all timecode and machine control output - this is especially useful to prevent external machines trying to chase the console timecode.

**2.13.12 Macros .....**

Selecting **Macros** from the **Setup** menu opens the **Macros** display. This display is also opened by pressing the **assign** button in the **macros** area of the worksurface.



This is where macro commands can be assigned to the smart keys or Macro buttons in the **macros** area of the console surface, as well as to the function (F) buttons on the external keyboard and to the console's GPIs. Macros can also be fired directly from this list by touching the macro when none of the right-hand buttons is active.

The **macros** area has capacity for either 8 or 40 macros, arranged in one bank of eight, four banks of 10 or eight banks of five depending on the console. If the console has bank buttons, pressing any of the bank buttons across the top of the **macros** area assigns the **smart keys** below them to that bank. The bank currently assigned to the smart keys is indicated by its button being ringed green.

The **Macros** display includes a list of all the macro commands which have been created, along with the button to which they have been assigned, if this has been selected. The list is scrollable using the scroll bar to the right of the list.

*Note that this list therefore includes macros which have been created but have no trigger.*

Pressing the **Transport** Button will automatically assign the console transport controls to the macro buttons overwriting any existing assignments.

On SD8,9,11, pressing the **floating labels** button opens a panel on the console's master screen that shows the worksurface macro buttons and their name label if macros have been assigned to them. Touching either the button or the label will fire the macro.

To create a new macro, touch the **new** button, in the top right-hand corner of the display. To create a macro based one that already exists, touch the **duplicate** button below the **new** button, followed by the macro you wish to duplicate. When either

# Chapter 2 - The Master Screen

button is touched, a macro is created with the default name **macro n** where n is an auto-incrementing number, and the **Macro Editor** display (described below) is opened. A duplicate macro will contain all of the settings of its parent, apart from the name.

To edit a macro, touch the **editor** button below the **duplicate** button, followed by the macro you wish to edit. The **Macro Editor** display (described below) will then open.

Macros can be assigned from the main **Macros** display without opening the **Macro Editor** by touching the **assign** button below the **editor** button, touching the macro you wish to assign, and then pressing the button to which you wish to assign the macro.

Macros can be deleted by touching **delete files**. To delete all the macros in the list, touch **select all**, followed by **confirm**. To delete one macro or a selection of macros, touch the macros you wish to delete followed by **confirm**. To delete a consecutive range of macros, touch **select range**, touch the first and last macros included in the range to be deleted, and touch **confirm**.

### 2.13.13 The Macro Editor .....

The **Macro Editor** is where macros are defined, including the commands included in the them and the control used to trigger them. Virtually any command within the console can be assigned to a macro, ranging from opening master panels to adjusting in-channel signal processing.

*Note that fx parameters are only available once fx units are in use in the session.*

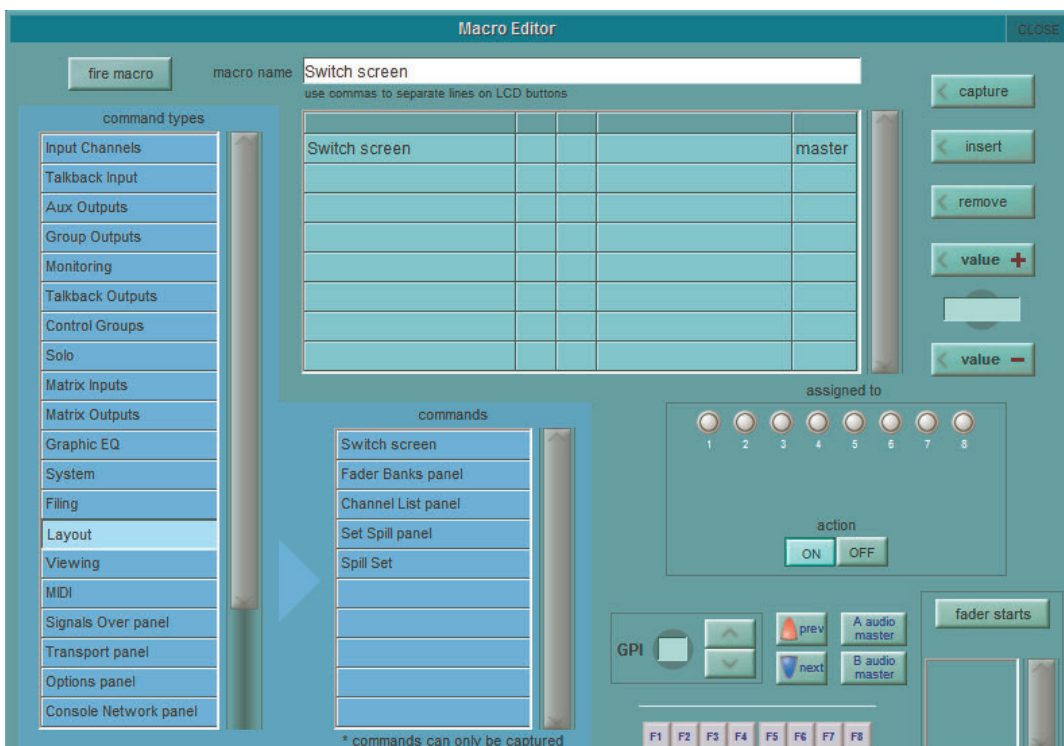

The name of the macro being edited is shown at the top of the display. To switch to a different macro in the list, touch the new macro in the Macro display list (You may need to move the displays around the panel to access the list). To rename the macro, touch the **macro name** text box, type the new name using the on-screen or external keyboard, and touch **OK**. This name will be used in the Macros display and also in the LCD display within a smart key assigned to that macro.

*Note that a line break can be inserted into the smart key macro name by typing a comma within the macro name text.*

The list beneath the **macro name** text box, lists the commands currently included in the macro. When there are multiple commands in the included commands list, they are triggered in the order in which they are listed. New commands are added to the selected row in the list, overwriting any command previously in that row. To insert a row for a new command in between two adjacent commands, touch the row above which you want to insert the command, then touch the **insert** button to the right of the included commands list.

There are two ways of adding a command to the included commands list:

1. Touch the row in the list in which you want the command to appear, then touch the **capture** button, located in the top right-hand corner of the display. The button turns pink to indicate that it is active. Any commands now actioned on the console will then be added to the included commands list. Once all the desired commands have been actioned, deselect the **capture** button.

2. Touch the row in the list in which you want the command to appear, then touch one of the command types in the scrollable **command types** list to the left of the display. This brings up a list of the commands within that command type in the scrollable **commands** list in the lower half of the display. Touch the desired command to bring it into the included commands list.

For commands associated with worksurface controls (all command types above **System** in the **command types** list), the included commands list displays the command type (in the **channel type** column), the scope of channels included in the command where appropriate (in the **from** and **to** columns), the command's name (**controller**) and any value associated with the command. For command types associated with the master panel (from **System** down), the included commands list displays the **command**, along with any **filename** or **value** associated with it. The list can be scrolled if necessary using the scroll bar to its right.

The values in the **from**, **to** and **value** columns can be adjusted by using the Touch-Turn encoder and **value +** and **value -** buttons to the right of the included commands list. Touch the box to be adjusted to assign it to the encoder and value buttons. The present value is shown in the display in between the value buttons. If the **value** column displays something other than numeric values, the options are cycled using the Touch-Turn encoder and **value +** and **value -** buttons (cycling for example, between **on**, **off** and **toggle**). Values can also be typed in by touching the value box, typing the new value using the external or on-screen keyboard, and touching **OK**.

To remove a command from the list, touch the command to be removed and touch the **remove** button to the right of the included commands list.

The bottom-right of the **Macro Editor** is used to define what triggers the macro. The **action** buttons below the **smart keys / macro buttons** are used to define whether pressing the button triggers a macro **on** or **off** command. Selecting a new trigger for a macro automatically deselects any old trigger that might have been assigned.

On SD7, SD5 and SD10, Smart keys are selected by touching one of the eight bank buttons below the **assigned to** legend (causing the button's ring to light green, indicating that it is selected) followed by one of its five **smart keys**. The smart key will then display the first command from the included commands list. The colour of the smart key can be chosen using the arrow buttons in the **colour** area below the smart keys. The selected colour is displayed between the arrow keys.

On SD8, SD9 and SD11 Macros are assigned in a similar way but directly to one of the 8 Macro buttons.

GPIs are selected by touching the **GPI** number box and using the Touch-Turn encoder, or by using the arrow buttons to the right of the **GPI** number.

**OSC** assignments are selected by Touching the **OSC** button, then the number box and using the Touch-Turn encoder or by using the arrow buttons to the right of the **OSC/GPI** area. (**Note: OSC triggering only functions if External Control is enabled**)

Function keys on the external keyboard are assigned by touching the **F1** to **F8** buttons at the bottom of the display.

The **previous** and **next** snapshot buttons on the control surface can also have macros associated with them, using the buttons to the right of the **GPI** area.

It is also possible to fire a Macro in response to the Audio Master being changed. Different Macros can be assigned depending on whether Audio Master is being switched to A or B. These are assigned using the **A audio master** and **B audio master** buttons to the right of the **GPI** area.

Fader starts are configured in the bottom right-hand corner of the panel. Pressing the **fader starts** button opens a small configuration pop-up (shown below) as well as a **Channel List** display.



The four buttons above the **fader starts** button define what fader action fires the macro – **fader up**, **fader down**, **mute off** or **mute on**. Once this has been defined, touching any channel row in the **Channel List** will add that channel fader to the fader start, as listed below the **fader starts** button. If the **ANY** button is active, the Macro will fire when any of the associated faders are moved to the specified state; if **ALL** is active, the Macro won't fire until all associated faders are in the specified state.

**Note that fader starts are associated with the channel, not the fader – if a channel is moved, any fader start functionality will move with it.**

# Chapter 2 - The Master Screen

Whenever a macro button is pressed, it performs what we call an On action. This is the first press of the macro button. The next press of the same macro performs an Off action. These On and Off actions can be the inverse of each other, so instead of having alternative presses of the macro button just toggle the state of a controller, you can program the macro button so that first press is a definite mute on command and the 2nd press of the macro button is a definite mute off command. This has the advantage of being able to provide an indicator on the Macro button of the state of the controller. On and Off states can have different colours and different text.

Macros can be tested by touching the **fire macro** button, located in the top left-hand corner of the display. Once the macro has been fully configured, close the **Macro Editor** display.

### 2.13.14 Talkback .....

The **Talkback** display is opened by selecting **Talkback** from the **Setup** menu. This is where the talkback busses are configured.

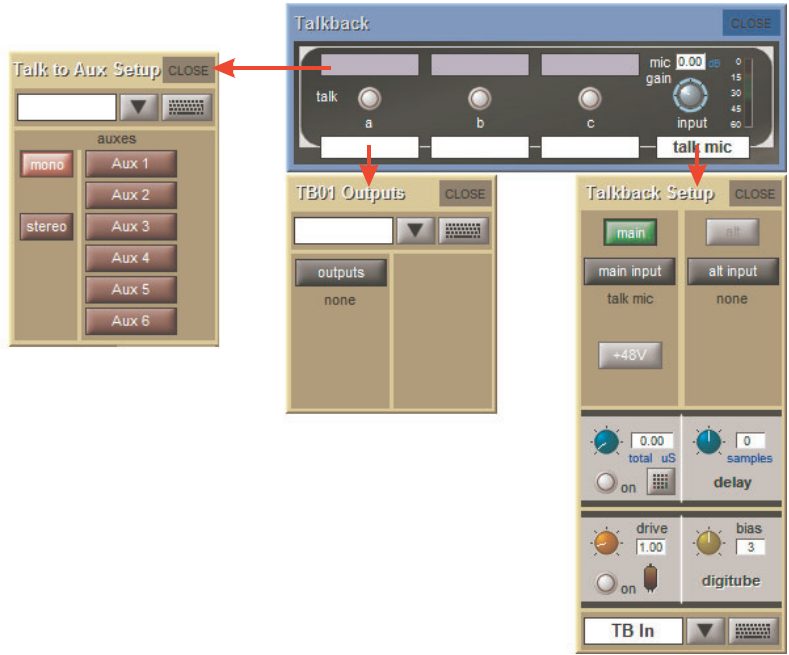

In the right-hand side of the **Talkback** display, there is a mic **input** gain pot which is always assigned to the **gain** encoder in the worksurface talkback area. The pot's gain value is indicated in dB in the box above the pot. The talkback signal level is shown in the meter to its right. Touching the white box below the gain pot opens up the **Talkback Input** display which consists of an **input route** button. The current route is displayed below the button. Pressing the button opens up the **TB Input Route** display, which functions in the same way as all other input routing panels.

To the left of the input section of the display, there are talk buttons with text boxes beneath them. Touching each button enables and disables the corresponding talkback button on the worksurface. The button rings red to indicate that the buss is active. Touching the text box beneath the button opens the **TB Outputs** display for that talk bus. This consists of a naming area and an **outputs** button. The first output currently selected is displayed below the button.

Pressing the button opens up the **TB Output Routes** display which functions in the normal way. The first selected route appears in the text box below the talk button.

The three blue coloured text boxes above the buttons provide access to a panel allowing the selection of a number of aux busses.

Once selected, the Talkback button will automatically activate the talk To Aux functions on those busses. This enables you to talk to multiple Auxes of your choice at the press of a single button.

### Talk To Auxes

In order to talk to individual or multiple of Aux outputs there is an assignable row of controls on Aux channels, controllable independently or from the **Talkback** panel which has a **Talk to Aux Setup** list for each Talk button.

This is implemented as a Talkback Input channel which uses a single engine processing channel to provide the aux sends. This channel appears, in a default session, on its own in the last bank on the left of the console.





On the Aux Output channels, hold one of the **Assign** buttons next to the row of assignable controls and then touch the **talk** area of the screen. This will assign the selected rotary control and switch to the talk level and talk on/off.

These are used to switch Talk to Aux On/Off, control the level of talkback signal and set the level of dim when the talk is active. A **dim** function is available for reducing the level of aux programme while the talk function is active. This is set using the 2nd Function of the assigned controls.

The worksurface **talk** buttons can also be programmed to activate the Talk function on single or multiple user defined channels. Open the **Setup/Talkback** panel and touch the label above the **talk** button, then select any combination of Mono and Stereo Auxes to activate with that button.

### 2.13.15 Text Chat (SD5, SD7) .....

Text messages can be sent from console to console on any MADI Port that is defined as "**Console**". This definition uses the last 8 audio inputs and outputs on the port to send text or video communications. The default setup of the SD7 defines MADI Port 4 as "Console". With MADI connections from one SD7's Port 4 In/Out to another SD7's Port 4 In/Out, open the **Setup>Text Chat** panel, press the **4:Con** button to activate the link on that port and then type a message. When you press the keyboard **Enter** key, the message will be transmitted and will appear in the other console's Text Chat panel. This process is bidirectional so the other console can send messages back in a similar way. This communication can also be achieved across an optocore connection.

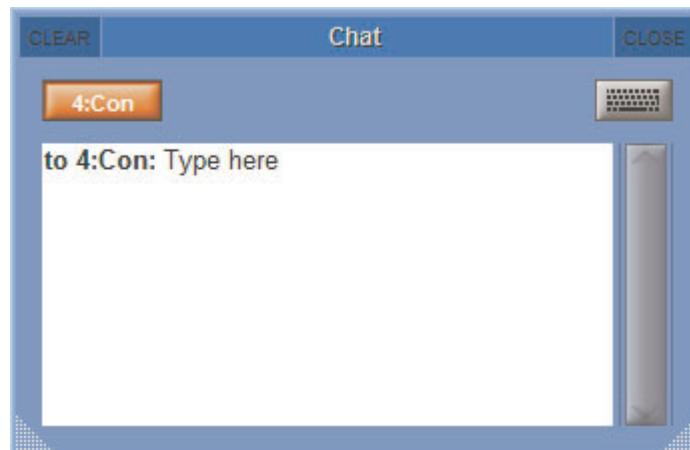

# Chapter 2 - The Master Screen

## 2.13.16 Video Link (SD7 Only) .....

The **Setup>Video Link** panel allows the routing of one of several different video signals to the console video screen. The worksurface buttons to select between these 3 sources can be found at the top of the console's centre section and are duplicated at the top of the on screen panel. There is also a **Self** button to send the console's own camera signal to the screen.

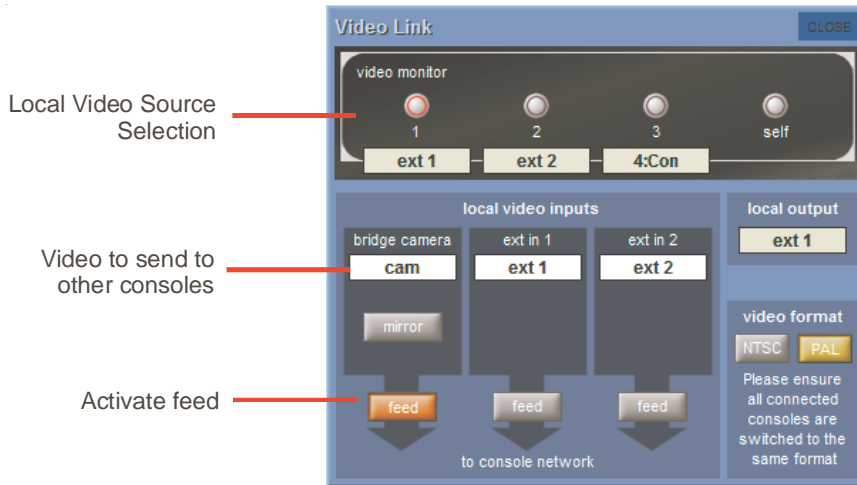

To define the source associated with each button, touch the white label box below the on screen label and a drop down menu will appear.

Potential sources include the console's two external video inputs (**Ext 1 & Ext 2**) located on the back panel and any optocore equipped SD7 engines that are connected. Optocore engines are identified by their Optocore Loop number (normally 1) and their Optocore ID which can be seen and set at the top of the console's **Network** panel.

The lower part of the Video Link panel determines which video source is fed from the console to the video network. Only one source can be sent at one time and this is done by pressing the **Feed** button beneath the required source.

Select the appropriate video format using the **NTSC** and **PAL** buttons, ensuring that all connected consoles are using the same format.

The console's camera feed can also be sent as a **Mirror** image using the on screen buttons.

**NOTE: The Options menu, which will appear beneath Video Link in the Setup menu if Waves is active, is described in Section 5 of this chapter.**

# **SD Software Reference Manual**

## **Chapter 3:**

### **Connections & Multiple Console Setups**

# Chapter 3 - Connections & Multi Console Setups

## 3.1 Console Audio Connections

SD Series console external audio connections can be made using either BNC MADI (AES10), Optocore or the DiGiCo Cat5e Connection.

There are 2 types of MADI connection available. A DiGiCo Stage rack can be connected to a console via a bi-directional MADI connection will have upto 112 channels (56 in, 56out) of audio plus the control data for the Rack (located on CH57). A Bi directional standard MADI stream will contain upto 128 channels of Audio (64in, 64out) and can be connected to any 3rd party device that has MADI connection.

A DiGiCo Cat5e connection is a Bi Directional up to 64 Channel I interface that uses STP Cat5e Cable with interference suppressors fitted on each end used to connect D-Racks and SD9 and SD11 Consoles.

## 3.2 Multi-Console setups

### 3.2.1 FOH & Mons sharing a stage DiGiRack (MADI) .....

It is possible for 2 SD7 consoles to share the inputs from a remote DiGiRack by using the 2 sets of MADI ports on the rack. In this situation, only one of the consoles can control the rack functions such as the analogue gain of the mic pre amp and the phantom power switching.

The suggested setup for two SD7 consoles which are sharing the same racks is as follows:

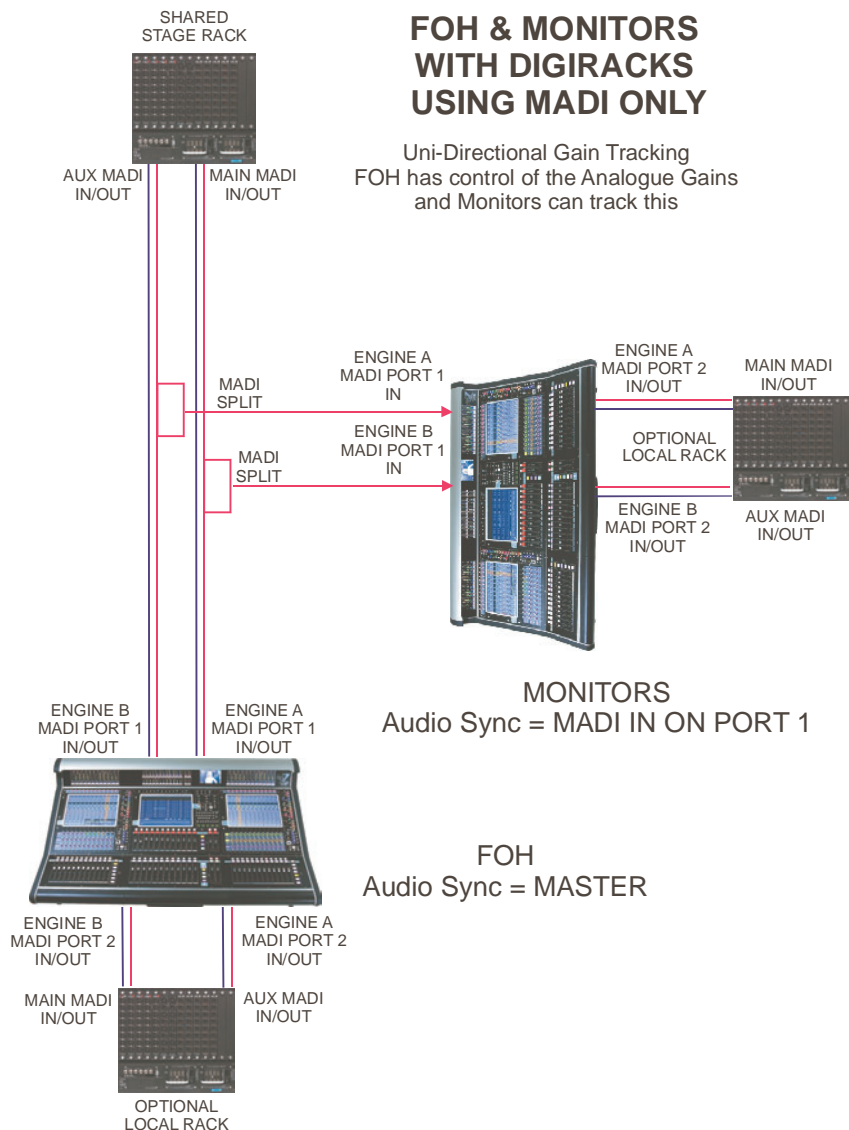

When using DiGiRacks on MADI, because each SD7 has 2 engines there is a requirement to split the rack's MAIN and AUX MADI OUT signals to feed the second console's MADI IN ports.

The recommended connection between the Monitor console and Stage Rack is a single MADI OUT from the Stage Rack's AUX MADI connected to the console's MADI 1 IN..

The FOH (Master console) is connected via MADI IN and OUT to the stage rack.

A similar method can be used if the Monitor console requires gain control and the FOH console will track the gain changes.

MADI OUT from the Stage Rack's AUX MADI connected to the FOH console's MADI 1 IN..

The Monitor (Master console) is connected via MADI IN and OUT to the stage rack.

- 1) Open the **Setup>Audio I/O** panel, select the shared rack port from the port's list (eg Port 1) and then press the **Shared** button for that rack. Do this on both consoles and the rack control functions **Isolate/Receive Only/Full Control** will become available.
- 2) One console should be fully connected to the racks using the **Setup>Audio I/O** panel's **Full Control** button for the **Shared** racks.
- 3) The operators should agree on and set a level of analogue gain that provides enough headroom for the required application.
- 4) The second console should connect to the Shared racks in **Receive Only** mode
- 5) Gain Tracking (the **Track** buttons at the top of the Input channel screen) can be switched on for the console that is in **Receive Only** mode for all the channels that are being shared.
- 6) When an analogue gain control is changed on the "Master" console, the "Slave" console's analogue gain should reflect the changes and the digital trim control should compensate for this change by moving by the same amount in the opposite direction.

### Relative Gain-Tracking - Snapshot Recalls Total Gain

"Relative Gain-Tracking" is implemented as a "Snapshot Recalls Total Gain" option at the bottom of the Snapshot Global Scope panel. When a snapshot recalls an input channel trim, it compares the snapshot's stored analogue gain against the current gain on the channel's input socket. If there's a difference it offsets the value recalled by the trim. This only happens when the socket's rack is in Receive Only, or the analog gain is not in Recall Scope.

### 3.2.2 FOH & Mons sharing a stage SD Series Rack (MADI).....

When using SD Racks the setup is very similar but the rack split from an SD Rack can be achieved without an external splitter. The SD rack has two built in split outputs which can each provide a 56 channel MADI stream at 48KHz. The added advantage of the SD rack split is that it can be set to provide an automatically gain tracked MADI stream. This can be set on the rack itself or from the Audio I/O panel on the console. This means that the receiving console does not need to provide the gain tracking facility.

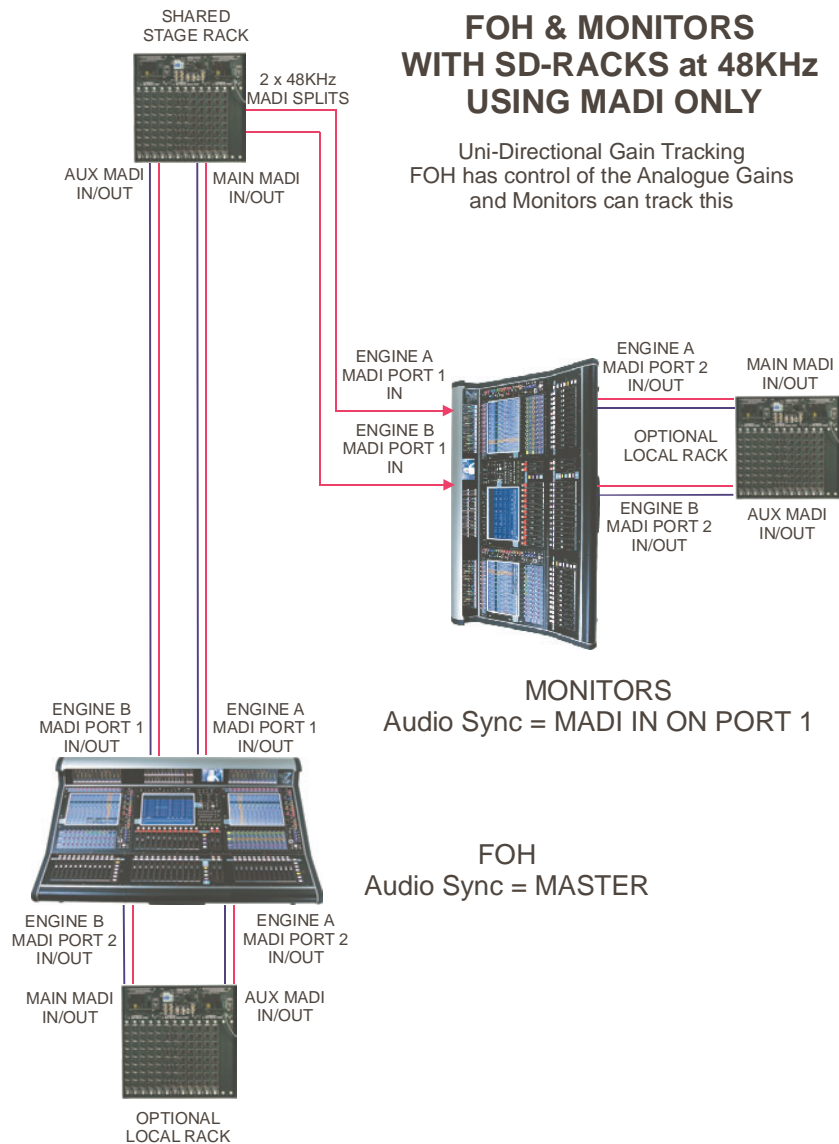

**Note - The console that is controlling the gains should be set to Setup / Audio Sync = Master and the console that is tracking should be set to Setup / Audio Sync = MADI 1**

## Chapter 3 - Connections & Multi Console Setups

### 3.2.3 FOH & Mons sharing DiGiRacks (Opto V220) .....

If 2 SD7's and DiGiRacks are connected with optical fibre, a similar setup can be achieved in the following way:

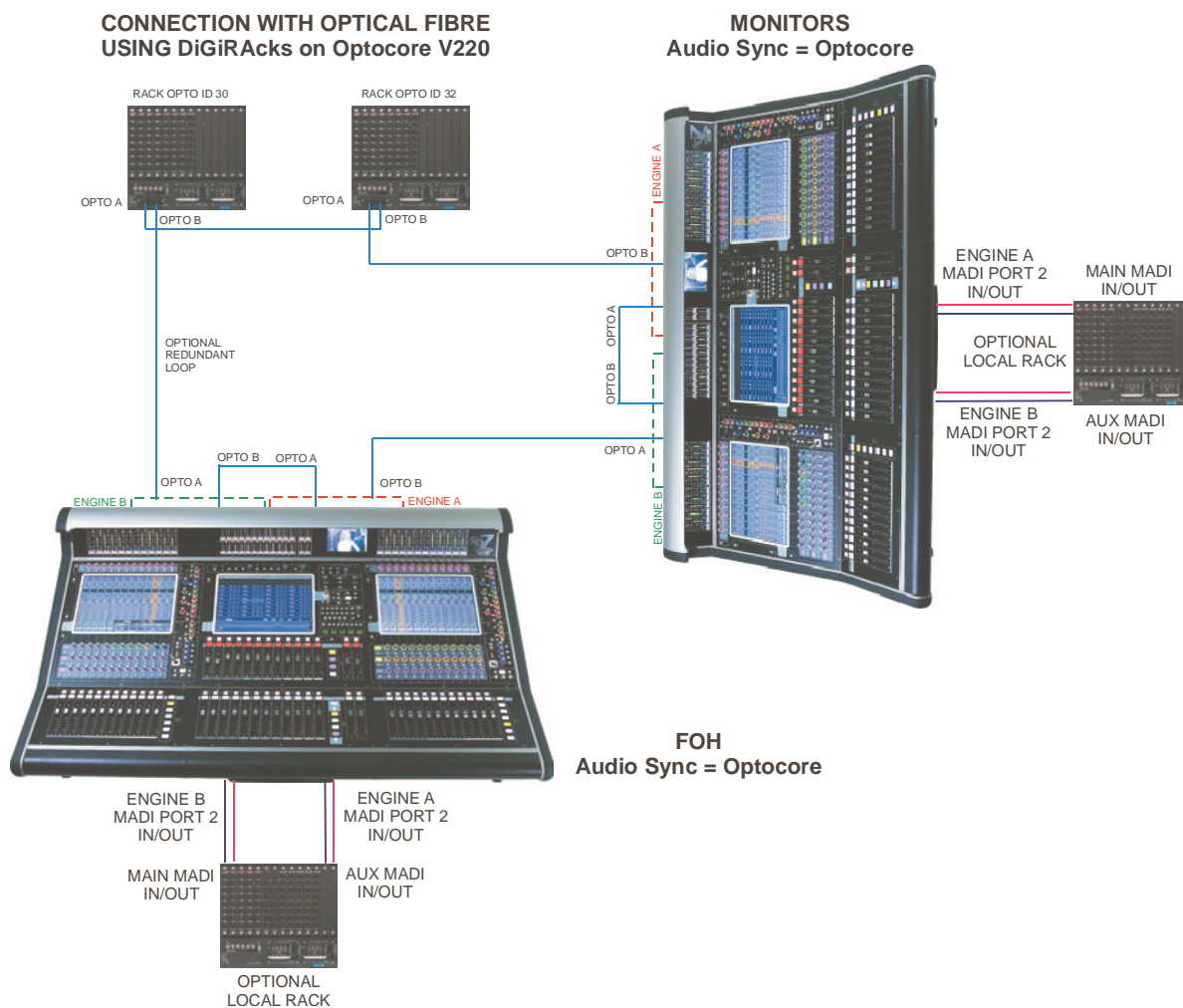

In this setup, you are limited by Optocore firmware Version 220 to four SD7 engines (2 consoles) and four Optocore connected racks. The system can only run at a sample rate of 48KHz.

Only one of these consoles will be able to use the outputs on Optocore connected racks and this console must be set to Optocore ID1 (Engine A) and ID2 (Engine B). The other console should be set to ID3 (Engine A) and ID4 (Engine B).

These IDs are set from the Network panel in the Master screen.

The four racks can have any Optocore ID in the range ID30 to ID33. In the above example they have ID30 and ID32. These IDs are set on the racks themselves.

The connections that should be made are shown in the diagram, as follows:

The fibre optic cables connect between each device on the optic loop, and connect an "A Port" to a "B Port". You should not connect the optic cables in A-A or B-B configurations. The cables connect between each device to form a closed loop. This is necessary for the redundant loop to operate correctly.

The diagram also shows each console having a local MADI connected DiGiRack using BNC MADI cables.

The DiGiRack Main MADI Port is connected to one of the MADI Ports on Engine A and the Aux MADI Port is connected to the same numbered port on Engine B.

Open the **Setup > Audio Sync** panel and set the Sync source to be Optocore. Do this on both engines of both consoles. Save and Send the Session from the A engine on each console to its B engine and Mirror each pair of engines.

Now open the **Setup > Audio IO** panel on the A engine of both consoles, and press the **Conform All Ports** button in the bottom left corner. The console will "look" down the connected optical fibre cables and auto discover and conform all the racks it can find. In this example, they will find 2 optic stage racks. This function will be automatically mirrored to the B engine on each console.

In its default setup, none of the optocore connected DiGiRacks will be defined as shared. This means that either console will be able to control the rack and adjust Mic Amp Gain, Phantom Power, output pads etc.

If you are happy for either desk to control the racks, then you can leave the sessions with these default settings. Making changes to this default state allows you to define the shared status of each rack. If you set a rack to be in full control, then that console

will have full control of the rack. If you set a rack to be in receive only mode, then that console will not be able to make changes to mic amp gain etc, but will “see” the changes made by the other console. This is necessary for Gain Tracking to function. The third option is isolate, and when in this mode, the console will not be able to make changes, nor see changes made by someone else. Gain tracking will not work if the rack is set in isolate mode.

To set a console as the master controller for the racks : In the Audio IO Panel, select the appropriate stage rack. Press the **Splits and Sharing** button. In the section titled **Selected Rack**, press the **shared** button. It will default to the Isolate setting. Then press the **full control** button. A warning will remind you that going into full control may affect the live audio.. then press **Yes**. If required, repeat this process for the second stage rack.

To set racks to be in receive only mode : In the Audio IO Panel, select the appropriate stage rack. Press the **Splits and Sharing** button. In the section titled **Selected Rack**, press the **shared** button. It will default to the Isolate setting. Then press the **receive only** button. A warning will remind you that your session will change to correctly reflect the actual settings on the rack.. then press **Yes**. If required, repeat this process for the second stage rack.

### 3.2.4 FOH & Mons sharing SD Series Racks (Opto V221) .....

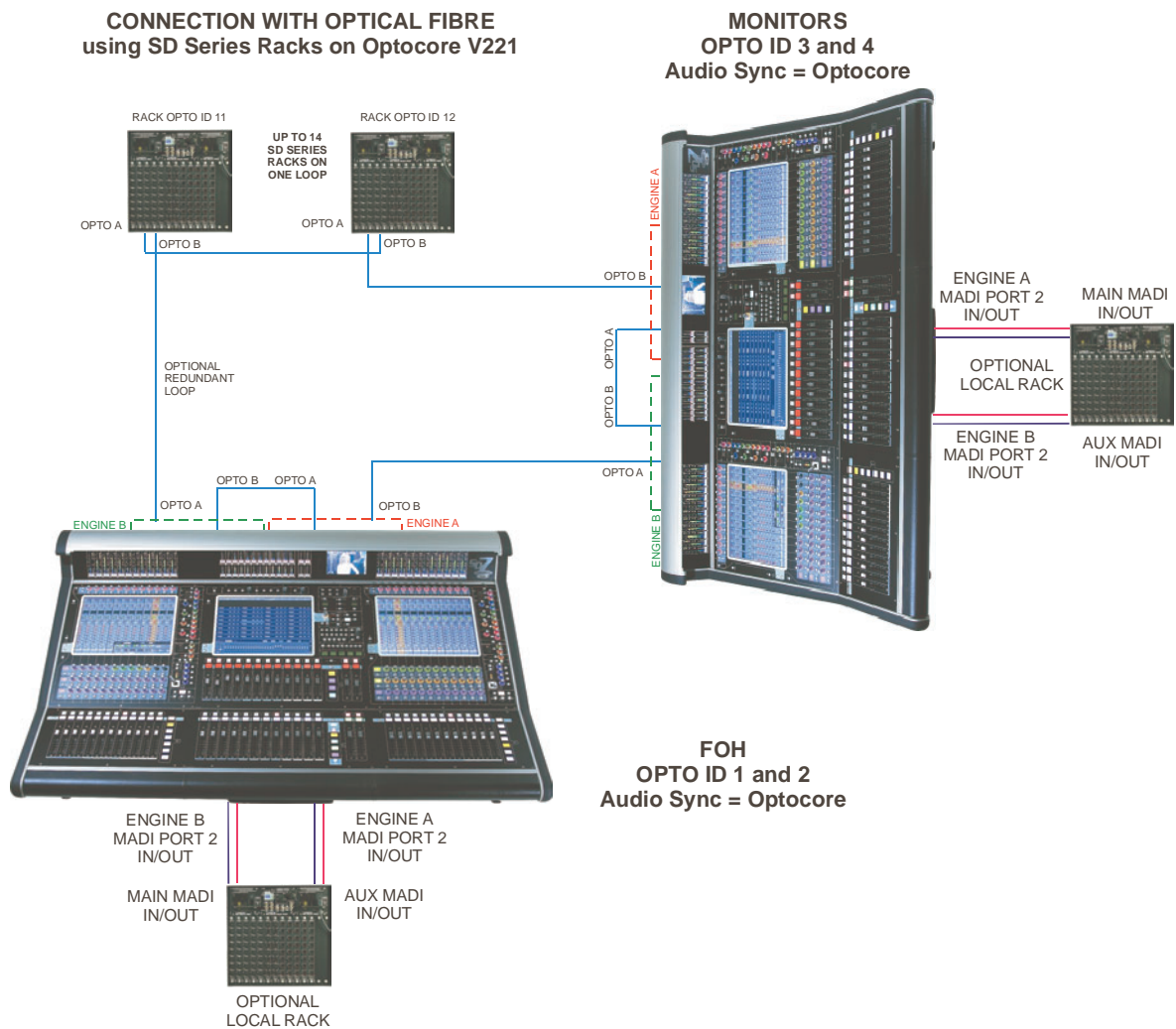

It is possible for up to 5 DiGiCo consoles to share the inputs from remote stage SDRacks using optical fibre cables. It is also possible for the output cards in the SDRacks to be allocated to the consoles on a card by card basis.

The following example describes how to set up 2 consoles with a pair of stage racks in a Front of House & Monitors configuration. The connections that should be made are shown in the diagram, as follows.

The fibre optic cables connect between each device on the optic loop, and connect an “A Port” to a “B Port”. You should not connect the optic cables in A-A or B-B configurations. The cables connect between each device to form a closed loop. This is necessary for the redundant loop to operate correctly.

The diagram also shows each console having a local MADI connected SDRack. These are connected using pair of BNC MADI Cables between one of the MADI ports on the console and the Main MADI ports on the SDRacks. Additional redundant MADI cables can be used, connected the redundant MADI ports on the console to the Aux MADI Ports on the SDRack.

# Chapter 3 - Connections & Multi Console Setups

---

## Console Setup & Operation

To ensure correct operation of this system, it is necessary to ensure that the console and session settings are correct.

Each Optically connected device must have a unique ID. On each console, open the **Network** panel on the Master Screen. From the drop down list at the top of the panel, set the ID of each console. We would recommend setting the FOH console to ID1 and ID2 and the monitor console to ID3 and ID4. Even numbered ID's are used for Redundant engines in Mirrored engine setups therefore if you were mirroring two single engine consoles, they should be set as ID1 for the FOH console and ID3 as the Monitor console. Similarly, each SDRack should have it's ID set. Rack ID's start from 11; this example uses Optocore ID's 11 & 12 for the 2 connected racks.

On each console, ensure that the session sample rates are the same. The sample rate is set in the **Files > Session Structure** panel.

Open the **Setup > Audio Sync** panel and set the Sync source to be Optocore. Do this on both engines of both consoles.

Save and Send the Session from the A engine on each console to its B engine and Mirror each pair of engines.

Then open the **Setup > Audio IO** panel on the A engine of both consoles, and press the **Conform All Ports** button in the bottom left corner. The console will "look" down the connected optical fibre cables and auto discover and conform all the racks it can find. In this example, they will find 2 optic stage racks.

If the conformed racks in each of the engine's Audio IO panels do not match the other console, then the system will not map correctly. Before the system is mapped, you should allocate any SDRack output cards. Press the **Setup Optocore** button select / deselect output cards as required. Once this is complete, press the **Remap All Optocore** button.

[For more detailed information on the Optocore Setup, please refer to Optocore\_221\_User\_D.pdf which is available for download from the Support section of the DiGiCo website and as an Appendix to this manual.]

In its default setup, none of the optocore connected SDRacks will be defined as shared. This means that either console will be able to control the rack and adjust Mic Amp Gain, Phantom Power, output pads etc.

If you are happy for either desk to control the racks, then you can leave the sessions with these default settings. Making changes to this default state allows you to define the shared status of each rack. If you set a rack to be in full control, then that console will have full control of the rack. If you set a rack to be in receive only mode, then that console will not be able to make changes to mic amp gain etc, but will "see" the changes made by the other console. This is necessary for Gain Tracking to function. The third option is isolate, and when in this mode, the console will not be able to make changes, nor see changes made by someone else. Gain tracking will not work if the rack is set in isolate mode.

To set a console as the master controller for the racks : In the Audio IO Panel, select the appropriate stage rack. Press the **Splits and Sharing** button. In the section titled **Selected Rack**, press the **shared** button. It will default to the Isolate setting. Then press the **full control** button. A warning will remind you that going into full control may affect the live audio.. then press **Yes**. If required, repeat this process for the second stage rack.

To set racks to be in receive only mode : In the Audio IO Panel, select the appropriate stage rack. Press the **Splits and Sharing** button. In the section titled **Selected Rack**, press the **shared** button. It will default to the Isolate setting. Then press the **receive only** button. A warning will remind you that your session will change to correctly reflect the actual settings on the rack.. then press **Yes**. If required, repeat this process for the second stage rack.



**Appendix A**  
**DiGiCo**  
**Optocore V221**  
**For SD Rack Optocore Operation**

Issue E - May 2014



---

# Contents (Appendix A)

<b>A1.1 Optocore V221 - Introduction .....</b>	<b>A1-4</b>
A1.1.1 System Overview .....	A1-4
A1.1.2 Opto V220 (DiGiRacks) and Opto V221 (SD Racks).....	A1-5
A1.1.3 Replacing DiGiRacks with SD Racks .....	A1-5
A1.1.4 Replacing SD Racks with DiGiRacks .....	A1-7
<b>A2.1 The Audio IO Panel .....</b>	<b>A1-8</b>
A2.1.1 Layout .....	A1-8
A2.1.2 Quick Start Guide for SD V370+ and Optocore V221.....	A1-8
A2.1.3 Audio Sync .....	A1-12
A2.1.4 The Port List .....	A1-12
A2.1.5 Managing Ports .....	A1-12
A2.1.6 SD Rack Splits .....	A1-13
<b>A3.1 SD Series Dual Loop Optocore Systems .....</b>	<b>A1-13</b>
A3.1.1 Important Considerations .....	A1-13
A3.2.1 Setting up a Dual Loop System .....	A1-14
A3.2.2 Console Snd/Rcv Ports .....	A1-14
A3.2.3 Single Loop Console on Loop 2 .....	A1-15

## A1.1 Optocore V221 - Introduction

### A1.1.1 System Overview .....

The new V221 DiGiCo Optocore fibre system provides users with a highly flexible system. In order for correct and safe operation of the system, the basic principles need to be understood.

A DiGiCo fibre loop now supports up to 10 SD Engines (5 Redundant Consoles) and 14 Racks. These are identified as follows.

**NOTE: For more information on Dual Loop Optocore systems please refer to the relevant section of this Appendix**

SD Engines are allocated ID's between 1 and 10. SD7 Consoles with 2 Engines are allocated ID's in consecutive pairs.. 1&2, 3&4 etc. SD8 Consoles only have a single Engine and therefore only have a single ID. If 2 SD8's are to be configured as a redundant pair, then their ID's should be allocated consecutively, in the same way that SD7 redundant Engines are paired.

SD Racks (and Optocore enabled D-Racks) are allocated ID's between 11 and 24

**NOTE: SD Racks can be set to Opto IDs 1 to 10 but the racks will not work on the Optocore loop if set to these values. These values are used for factory testing only**

As with previous Optocore systems, each device must have a unique ID. Additionally, each device must also be set to run at the same speed. The previous Optocore system was fixed at 1G. The default speed for the new system is 2G.

Each Optocore loop (running at 2G) is capable of 504 channels of audio at either 48k or 96k. On an SD7, up to 2 loops can be operated, providing up to 1008 channels of Optocore I/O

The Optocore Interface card (between Optocore connected devices and the SD Engine) supports 496 Input and 496 Outputs. Inter-console IO is also catered for, allowing the transmission of Audio and Video between SD Engines.

This Optocore system allows for many more channels of audio than can be simultaneously routed into and out of the console. The limit of simultaneously routed signals is 384 inputs and 384 outputs, including routing to local IO and MAD1 connected devices.

The V221 Optocore implementation provides additional functionality and features over the original Optocore system, as follows.

All inputs (to racks) are available to all consoles. However, it is possible for any console to opt-out of inputs, on a per-input card basis. This means that when the channel routing panel is then opened, only the relevant inputs are accessible. This is particularly in a larger shared system.

Output cards can be allocated / assigned to individual consoles. In practice, this allows a number of consoles sharing a single SD Rack to have an output card each.

The Optocore system can be "locked" by any console, and reconfiguring of the system is then not possible until all consoles have been placed in an unlocked state. Within a large shared system, this protection mechanism ensures that audio cannot be disrupted by another console on the loop.

In order to configure these allocations, the Optocore system has to be mapped. This map tells each device on the loop which fibre channels it is accessing – either to insert audio onto the loop or to extract audio from the loop.

Racks take audio in from external sources and insert them onto the loop. Consoles then extract this audio, which become the inputs into the console

Consoles route signals out to the loop (so insert audio onto the loop) and then racks extract this to route out to external devices.

In order for this to operate correctly, a map is built telling each device where it inserts signals onto the loop, and where it extracts audio from the loop.

The process of building this map has been made as simple as possible, and can be reduced to a few basic steps.

Connect the Consoles and Racks together, as required.

Input cards on the racks must be installed in a single block with no gaps between input cards. (So if your SD Rack only needs 5 input cards, they must occupy the first 5 slots in the rack)

On every console (SD Engine), open Audio IO and press the "Conform All Ports". This then will populate the Audio IO panel with all the connected devices. Every console must have the same Audio IO panel configuration.

Allocate Rack output cards to consoles as required.

Press the "Remap All Optocore" button.

**Please carefully follow the procedure in the Quick Start section later in this manual.**

---

### A1.1.2 Opto V220 (DiGiRacks) and Opto V221 (SD Racks) .....

SD Series consoles are now capable of operating with either one of two different Optocore firmware versions - V220 and V221. V220 is compatible with DiGiRacks and MiNiRacks and cannot be used with SD Racks or DRacks.

V221 is compatible with SD Racks and DRacks and cannot be used with DiGiRacks and MiNiRacks.

**Note: Any type of rack can be used with an SD Series console if it is connected with Coaxial BNC MADi irrespective of the Optocore version that the console is using.**

Sessions that have been created using Optocore connected DiGiRacks and MiNiRacks can be used with SD Racks and DRacks but a procedure must be followed to achieve this.

Sessions created using Optocore connected SD Racks and DRacks can also be used with DiGiRacks and MiNiRacks but this also involves a "conversion" procedure.

### A1.1.3 Replacing DiGiRacks with SD Racks .....

If you are connecting racks with Optocore and your session originally used DiGiRacks or MiNiRacks, you can replace these with Optocore connected SD Racks as follows:

- 1) Ensure that the SD Series console is running **Optocore Firmware V221** (See Technical Note 252)
- 2) In SD software V370+, load the session and open the Snapshot panel.
- 3) Make a snapshot (to save all routing, input gains and other rack parameters) and ensure that the Recall Scope can recall all of this information.  
To do this both Global and Recall Scopes should have Input and Output channels and Input and Output Devices ticked for all relevant input and output routes.
- 4) Open the Setup/Audio IO panel on the Master screen
- 5) Select the Opto ports (usually ports 5 and 6 which will be set as DiGiRacks) and set them to be SDRack, and set Optocore ID if required.  
The Optocore IDs will have the following equivalents by default:  
DiGiRack ID30 = SD Rack ID17  
DiGiRack ID31 = SD Rack ID18  
DiGiRack ID32 = SD Rack ID19  
DiGiRack ID33 = SD Rack ID20
- 6) Manually (or automatically if connected) conform the racks to match the previous hardware setup.
- 7) Recall the snapshot – this should reinstate all the routing lost when the DiGiRacks were converted to SD Racks
- 8) Check sync is set to Optocore
- 9) Ensure that the required rack output cards are assigned to your console Optocore ID number (2.1.2 Quick Start Guide)
- 10) Save session as a New File

**To run the console at 96KHz, two MADi Ports are required per 56 channel MADi stream**

**To convert the session to 96KHz (optional)**

- 1) Make sure that MADi Ports 1-4 are all defined as DiGiRacks
- 2) Open Session structure and select 96K sample rate with appropriate mode eg 96 busses mode and Restructure
- 3) When you open Audio IO, you should now see 2 MADi Ports.. 1 : MADi 1/2 & 2 : MADi 3/4 .  
Ports 5 and 6 should remain as the SD Racks (as set above)
- 4) Save session as a New File

Device Type=DiGiRack  
Change to SD Rack

Connection cannot be changed at this time

Was Opto ID 30  
Now Opto ID 17

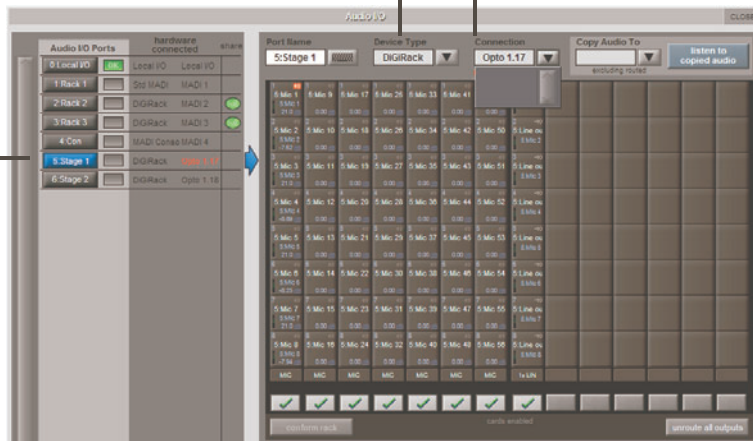

After creating a new Snapshot - Change Device Type to SD Rack



Now Conform this rack to recreate I/O cards and recall the snapshot to reinstate input gains etc

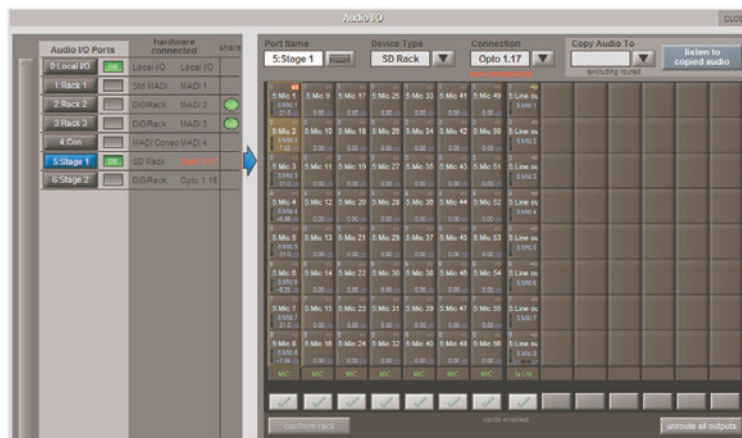

### A1.1.4 Replacing SD Racks with DiGiRacks .....

If you are connecting racks with Optocore and your session originally used SD Racks, you can replace these with Optocore connected DiGiRacks or MiNiRacks as follows:

**Note: Optocore V220 cannot run at 96Khz.**

**If you intend to use a 96Khz SD Rack (V221) session with DiGiRacks (V220) then the session should be Restructured at 48KHz and saved as a New File before attempting to downgrade the Optocore Firmware and proceeding.**

- 1) Ensure that the SD Series console is running **Optocore Firmware V220** (See Technical Note 252)
- 2) In SD software V370+, load the session and open the Snapshot panel.
- 3) Make a snapshot (to save all routing, input gains and other rack parameters) and ensure that the Recall Scope can recall all of this information.  
To do this both Global and Recall Scopes should have Input and Output channels and Input and Output Devices ticked for all relevant input and output routes.
- 4) Open the Setup/Audio IO panel on the Master screen
- 5) Select the Opto ports (usually ports 5 and 6 which will be set as SD Racks) and set them to be DiGiRacks, and set Optocore ID if required.

**Note: In Optocore V220, racks can only have Optocore IDs in the range of 30 to 33 and therefore if your SD Racks had V221 Optocore IDs outside of the range from 17 to 20, they will need to be changed.**

**The Optocore IDs will the following equivalents:**

#### V221 >> V220

- ID 1.11 = ID 1.2A (Not valid in V220)
- ID 1.12 = ID 1.2B (Not valid in V220)
- ID 1.13 = ID 1.2C (Not valid in V220)
- ID 1.14 = ID 1.2D (Not valid in V220)
- ID 1.15 = ID 1.2E (Not valid in V220)
- ID 1.16 = ID 1.2F (Not valid in V220)
- ID 1.17 = ID 1.30**
- ID 1.18 = ID 1.31**
- ID 1.19 = ID 1.32**
- ID 1.20 = ID 1.33**
- ID 1.21 = ID 1.34 (Not valid in V220)
- ID 1.22 = ID 1.35 (Not valid in V220)
- ID 1.23 = ID 1.36 (Not valid in V220)
- ID 1.24 = ID 1.37 (Not valid in V220)

- 6) Manually (or automatically if connected) conform the racks to match the previous hardware setup.
- 7) Recall the snapshot – this should reinstate all the routing lost when the SD Racks were converted to DiGiRacks.
- 8) Check sync is set to Optocore
- 9) Save session as a New File

## A2.1 The Audio IO Panel

### A2.1.1 Layout .....

**Rack hardware status**

**Port List**  
Press Button to Select

**Card status for optocore**  
Green tick = This console  
Red Cross = Available  
Red Cross Greyed Out = Unavailable  
**NOTE - Output cards can only be taken if no other console has them**

Adds Ports and Confirms all connected racks at the same time

Prevents changes to optocore settings on all consoles in the system

Select one of these 3 buttons to view relevant details

**Rack details**

Indicates card type and which Opto ID has ownership of Output cards

Assign or Disable all Optocore Inputs or Outputs on selected rack for this console

Remaps Inputs to Local console only

Optocore Remap button - should be used if a message appears indicating "Remap Required"

### A2.1.2 Quick Start Guide for SD V370+ and Optocore V221 .....

Switch on all consoles and SD Racks and ensure that each device has a unique Optocore ID. The console's ID is displayed in either Status Bar on the Master Screen, the Network Panel or on the Meter Bridge of an SD7. If you need to change an ID of an SD console, you will need to power cycle the SD console once the ID change has been made.

Optocore ID

**Console Network**

network status: **MIRRORED** Optocore ID **3**

transfer / mirror audio

**A** Console: SD7 (console001) [192.168.2.21]  
Session: File: d:\projects\369\mons day 4.ses  
File date: Status: MASTER MIRRORED **OK** **Audio Master**

**B** Console: SD7 B (CONSOLE002) [192.168.2.22]  
Session: File: d:\projects\369\mons day 4.ses  
File date: Status: STANDBY MIRRORED **OK** **Select** **Audio Master**

**REMOTES**

- mirrored
- mirrored
- off-line
- off-line
- off-line

session transfer

- Send Session to Selected
- Receive Session from Selected
- mirror
- Mirror to Selected
- Mirror from Selected
- Unmirror Selected



All SD hardware must be running with the same Fibre Speed. The default setting is 2G. The Current Setting can be found in either the Audio I/O panel or in the Optocore Diagnostics Panel. On an SD Rack, navigate to the Fibre Speed menu to check.

Audio I/O Panel  
Optocore Setup  
Fibre Speed



Connect all consoles and racks ensuring all Fibre connections are A to B.

Go to Files/Session Structure.

1) Select the appropriate Session Sample Rate using the buttons at the top of the panel:

48Khz - 128 Busses available

96KHz - 64 Busses available

96KHz - 96 Busses available

96KHz - 128 Busses available

The number of busses available is the total of Aux Busses and Group Busses used in your session.

2) Select the number of input channels, busses etc as required

3) Press the Restructure button to create your session.

4) Save your session when prompted to do so.

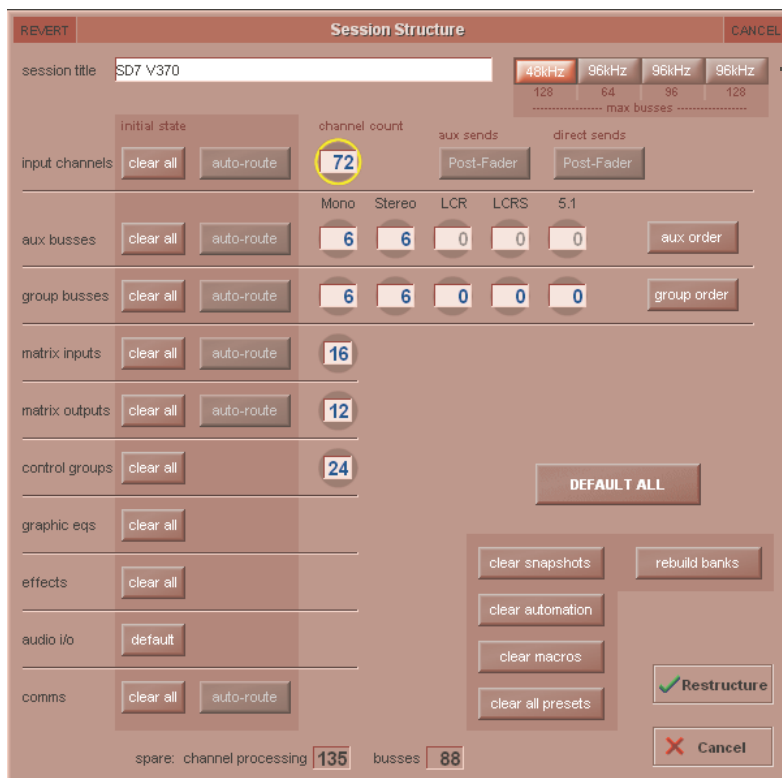

Select Session Sample Rate

# DiGiCo Optocore V221

Next, go to Setup/Audio Sync and set sync to Optocore. Please note that all consoles on the network must be running at the same sample rate.

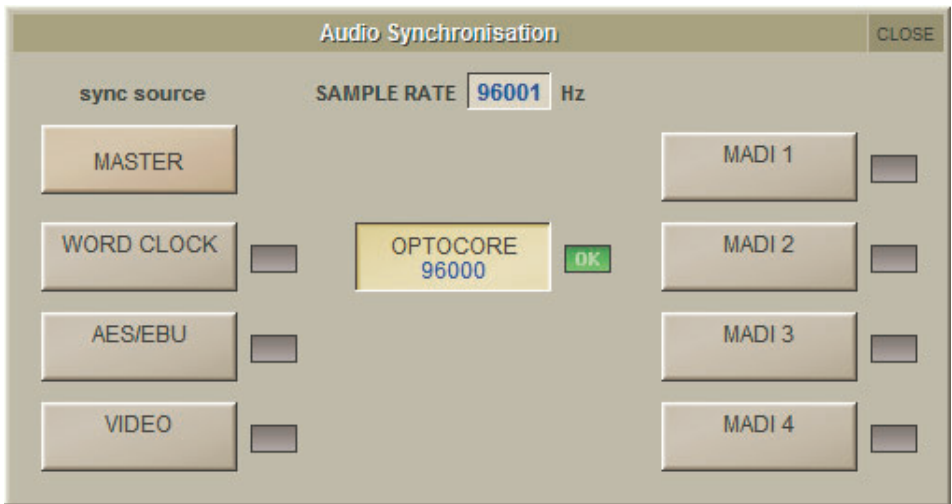

Once all hardware is connected, go to System/Diagnostics/Optocore. This will list all connected Optocore devices either SDeng (console engines) to SDrack (SD Rack or D Rack) by ID. If any expected devices are not listed, please check all physical connections, Optocore ID's and Fibre Speeds. Once all devices are present, close the Diagnostics panel.

**IMPORTANT NOTE: THE FOLLOWING INSTRUCTIONS DESCRIBE HOW TO AUTOMATICALLY CONFORM ALL THE RACK PORTS PRESENT IN THE SYSTEM. IF YOU ADD AND CONFORM THESE PORTS MANUALLY IT IS ADVISABLE TO LEAVE THE EXISTING MADI PORTS IN PLACE AND ADD NEW PORTS FOR OPTOCORE RACKS. THE MADI PORTS ALWAYS EXIST IN HARDWARE ON THE CONSOLE SO THEY SHOULD BE LEFT AVAILABLE FOR USE IN THE AUDIO I/O PANEL.**

**If the system only consists of a single SD Console:-**

On an SD7, save your session, then open the Network panel, send the session to the second console engine and then mirror the two engines.

Go to Setup/Audio I/O. Press the Setup Optocore button and the Single Console button will be shown with a bright red background. Press this button, press Yes at the confirmation stage and the console will create ports for all connected racks, allocate all output cards to your console and create the Optocore map. The system is now ready to use.

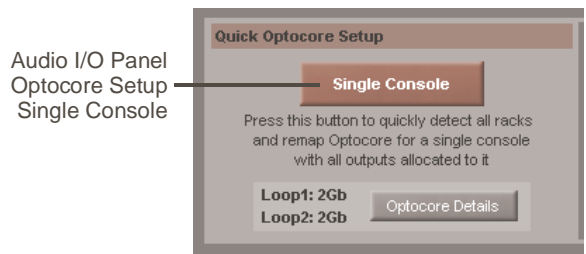

**If there is more than one SD Console present in the system:-**

Go to Setup/Audio I/O. Press Conform All Ports and Yes in the confirmation box. The console will now interrogate the system, create ports and conform all connected SD or D Racks. A green OK should appear next to each port along with the rack type and it's Optocore ID.

On an SD7, save your session, then open the Network panel, send the session to the second console engine and then mirror the two engines.

Repeat this process for all consoles in the system.

**NOTE - All consoles connected to the system MUST have all Optocore connected Racks declared in the Audio I/O**

Press Setup Optocore. This opens the panel and allows the allocation of Output Cards. The Box under each card displays one of four states.

- Allocated to this console and can be changed
- Allocated to this console and cannot be changed
- Not allocated to this console and can be changed
- Not allocated to this console and cannot be changed

If an output card has been allocated to a console, the Consoles ID will be shown at the bottom of the card. The only way to release an allocation is from the Audio I/O panel of the console it is allocated to.

**NOTE:** Changing card allocations with these buttons is only possible if the Optocore Setup button is pressed first

**NOTE:** You may choose to remove all existing output card allocations before making new ones but please be aware that this will affect all allocations on all connected consoles thus potentially removing allocations already made by other users.

To do this press the Optocore Details button in the Optocore Setup panel and then press the **Clear All Outputs** button.

The **Broadcast All Output ID's** button will broadcast **all the output allocations for all consoles** from the current console to all other consoles in the system and overwrite their allocations. Once this operation is initiated, there is no way to recover the other consoles original allocations.

The **Broadcast Only My Output ID's** button will broadcast **all the output allocations for the local console** from the current console to all other consoles in the system and overwrite their allocations. Once this operation is initiated, there is no way to recover the other consoles original allocations.

**IMPORTANT:** Only use these functions if absolutely necessary as their action is non recoverable.

The screenshot shows the 'Optocore Details' window. It contains a table with columns for 'input cards' (ID, name, ok, 1-7) and 'engine ID > output cards' (1-7). Below the table are summary statistics for two loops and engine totals. At the bottom right, there are four buttons: 'Broadcast All Output IDs', 'Clear All Outputs', 'Broadcast Only My Output IDs', and 'Close'. An arrow points from the text 'Clear all Output allocations on all connected consoles' to the 'Clear All Outputs' button. Another arrow points from the text 'Options to send output allocation information to other consoles' to the 'Broadcast All Output IDs' and 'Broadcast Only My Output IDs' buttons.

Once you have made your output allocations, the Optocore Map needs to be created. This is done by pressing the **Remap All Optocore** button. This requires a confirmation and will cause a small interruption to any audio passing through the system. The pressing of Remap All Optocore will instruct all connected consoles and racks to update their own Maps. Any change in Output allocations or the addition of any optically connected equipment will require the Map to be updated. When this is required, The background of the Remap All Optocore button will go bright red and Remap Required will appear underneath the button.

**NOTE - If any console in the system has its Lock Optocore button pressed, the re-allocation of output cards and Remap Optocore Functions are disabled.**

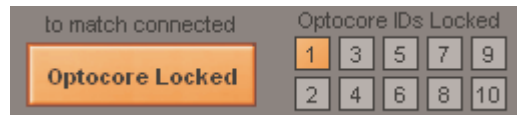

Within the Setup Optocore panel is Optocore Details. This Panel will give an overview of all connected audio I/O, output card allocations, available fibre channels (on both Loop 1 & loop 2) and available engine/Optocore interface channels. It also shows the current system Fibre speed and Sample rate.

This is a full screenshot of the 'Optocore Details' window. It shows the same table and summary statistics as the previous image, but without the callout arrows. The 'Broadcast All Output IDs' button is highlighted in red, indicating that a remap is required.

## A2.1.3 Audio Sync .....

In standard operation, all Optocore connected console engines should be set to **Audio Sync = Optocore**. In this situation the Optocore device with the lowest Optocore ID will automatically become the Master Sync source for the Optocore system. An Optocore system can be synced to an external Word Clock sync source by connecting that Word Clock source to any SD engine Word Clock Input and selecting Word Clock as the Sync source in the Setup/Audio Sync panel.

**NOTE: If 2 SD engines have Word Clock connected to them, the system will sync to the Word Clocked engine with the lowest Optocore ID**

An Optocore system can also be synced to a Word Clock source connected to the Word Clock input on any SD Rack. Connecting the Word Clock to the rack automatically sets this as the Master Sync Source. If any SD engine has a Word Clock sync source and is set to Word Clock sync, this will be used as the Master Sync Source instead of the SD rack.

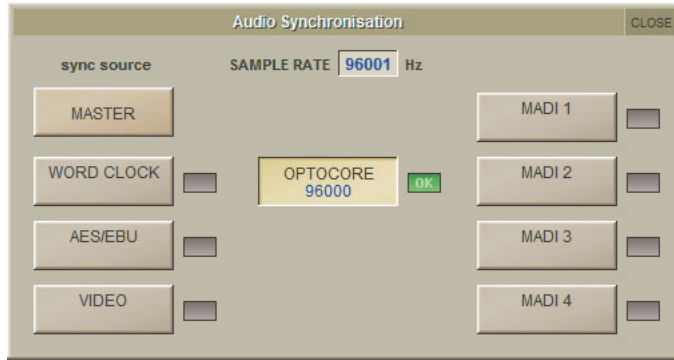

## A2.1.4 The Port List .....

The Port List indicates the status of the racks connected to each port.

Any red entries in the Hardware connected columns indicate either a mismatch in Rack card contents or in the Optocore map. There is also a column to indicate the Shared Status of each rack which can be set by pressing the **Splits and Sharing** button at the bottom of the Audio I/O panel, selecting the relevant rack from the Ports List and then using the **Selected Rack Shared** buttons.

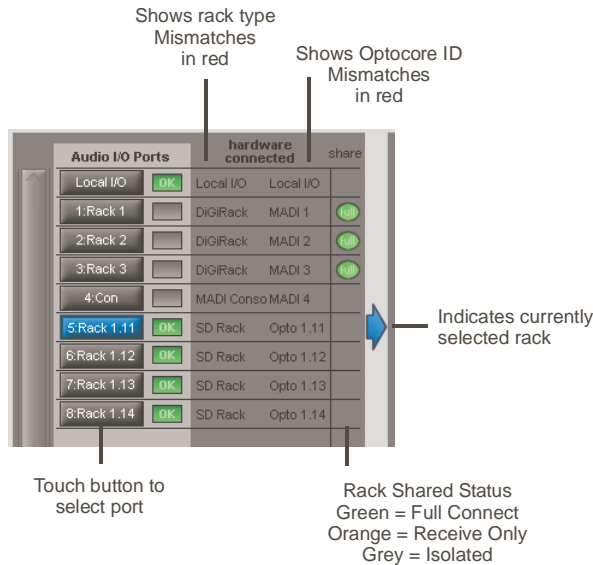

## A2.1.5 Managing Ports .....



The simplest way to set up a system is to automatically Conform All Ports and all relevant Ports will be created. However, Ports can be manually added and removed using the Add Port and Remove Port buttons. Pressing the Add Port button provides a list of Port types to choose from. There are different rack types and also Opto Send and Receive Ports.

### Console Opto Send and Receive Ports

Creating a Console Opto Send Port enables video (SD7 only) and up to 56 channels of audio to be sent between SD engines. A default port will consist of one video stream (1 rack card - 8 sockets) and 8 sockets of audio outs. When a Console Opto Send Port is created, matching Console Opto Receive Ports must also be created on all other consoles in the system.

The simplest way to create the Console Opto Receive Ports is to press the Conform All Ports button on all the other consoles and this will automatically create the relevant Receive Ports,

**IMPORTANT: When these Ports are added an Optocore Remap is required and this will only work correctly if all the consoles in the system have matching Send and Receive Ports.**

**A2.1.6 SD Rack Splits .....**

The SD Rack offers 2 dedicated Split outputs - Main and Aux plus the ability to split any input card to any output card.

If the rack is running at 48KHz, each rack split output provides a 48KHz Split.

If the rack is running at 96KHz the Main split output provides 96KHz channels 1-28 and the Aux split output provides 96KHz channels 29-56.

Alternatively, If the rack is running at 96KHz each split output can provide 56 channels at 48KHz.

The setting of these modes can only be adjusted on the SD Rack itself - please see the SD Rack documentation for details.

Each split can have automatic Gain Tracking that will compensate the output level for any changes in the relevant input gain.

All of these functions can be controlled on the rack itself through its own menu system but the console Audio I/O panel can also be used.

Be very careful when adjusting these parameters because they will obviously have a potentially dramatic effect on the rack's functionality.

**NOTE: A card split cannot be activated if the relevant output card has already been allocated to Optocore - it must be released by the console that it using it first.**

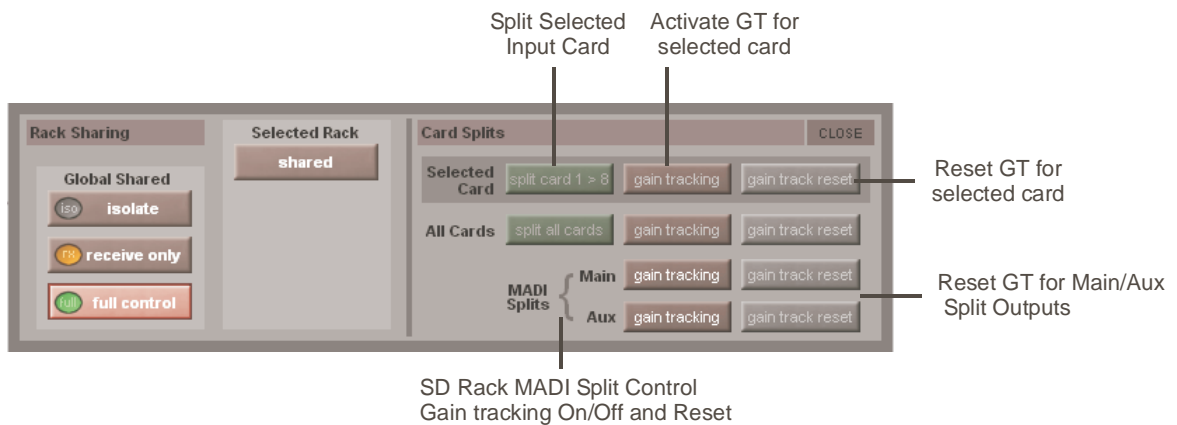

**A3.1 SD Series Dual Loop Optocore Systems**

**A3.1.1 Important Considerations .....**

The SD Series Optocore implementation is designed to allow 2 independent fibre loops to exist, with up to 14 SD Racks and 504 Channels of audio per loop at both 48K and 96K. This results in any dual loop console having access to 1008 Channels of IO, from up to 28 IO locations across the 2 loops.

Both the SD7 and SD5 have the ability to have 2 Optocore loops fitted.

When using a dual loop system, the following stipulations apply:-

**NOTE: Dual loop consoles must have the lowest ID's in the system**

In a system consisting of a dual loop SD7 and two Single loop SD10s, the SD7 Optocore Network ID must be 1+2. The SD10s can be set to any other primary ID eg 3, 5, 7 or 9.

In a system with two dual loop SD7s and two single loop SD10s, the 2 SD7s would have to have Optocore Network IDs of 1+2 & 3+4 and the SD10s would have IDs of either 5, 7 or 9.

**NOTE: Loop 1 and Loop 2 must be independent**

Loop 1 and Loop 2 fibres cannot be mixed. Anything connected to loop 1 can only exist on loop 1 and anything connected to loop 2 can only be connected to loop 2.

**NOTE: There can only be one Loop 2**

In a multi console, dual loop system, anything connected to loop 2 on one console must be present on loop 2 of all other consoles in the system. Each console cannot have its own independent loop 2 connection.

**Engine input and output limits**

The Optocore system can create a map for 1008 channels of audio across the two loops, however each engine can only have access to 496 inputs and 496 outputs across the 2 loops. Which inputs/outputs each console has access to is set in the Audio IO page.

## A3.2.1 Setting up a Dual Loop System .....

Each console and rack should have its Optocore network ID set accordingly. If a Dual loop console is ID 1, it will be ID 1 on both loops. Racks can only exist on either loop 1 or loop 2 therefore their physical presence on the loop determines which loop they are on. Pressing conform all ports in Audio IO will assign Rack IDs to either loop 1 or loop 2.

The picture below shows the Audio IO from a dual loop SD7 once all ports have been conformed and the system mapped.

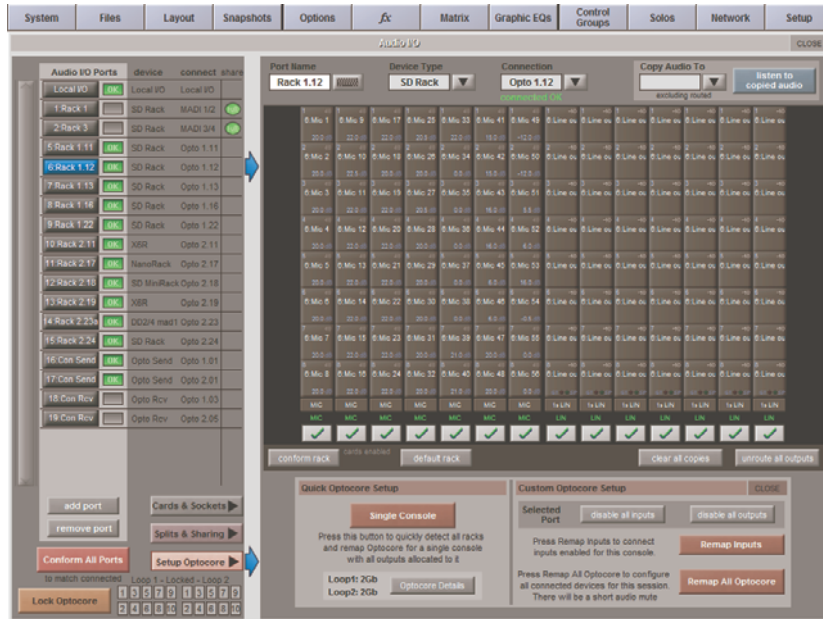

Racks on Loop 1 have IDs 1.XX and racks on loop 2 have IDs 2.XX

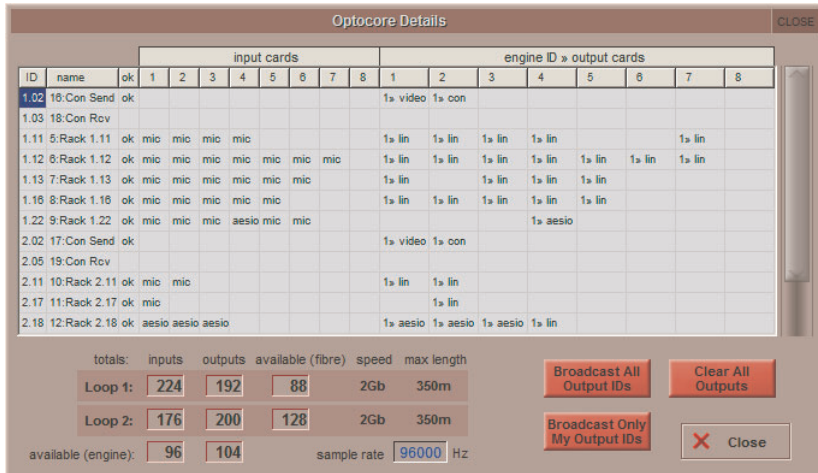

The Optocore Details Panel (shown above) shows the number of inputs and outputs mapped on each loop, the number of fibre channels available on each loop and the number of engine inputs and engine outputs remaining.

## A3.2.3 Console Snd/Rcv Ports .....

Each console can create an opto snd port for each loop and can also separate opto rcv ports for each loop.

The picture below shows ID 1 having a snd port for both loop 1 and loop 2 and rcv ports form ID3 on loop 1 and ID 5 on loop 2.

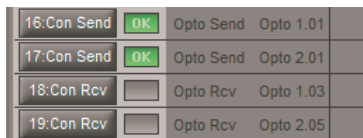

A dual loop console can have 2 snd ports (one per loop) and upto 8 Rcv ports (4 per loop). Console Snd/Rcv ports will use up some of your 1008 optocore channels and also Engine input and output resources.

### A3.2.4 Single Loop Console on Loop 2 .....

SD8, SD9, SD10 and SD11 consoles are only able to have connections fitted one loop and the internal connections within the console will be to loop 1.

In the Options>Console menu, the Enable Optocore option allows the console to either be a loop 1 console or loop 2 console (shown below) without having to alter the internal connections.

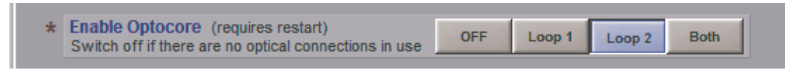

Single loop consoles operate independently on each loop. For example, a system can exist of a dual loop SD7 (IDs 1+2), an SD8 (ID3) on loop 1 and an SD10 (also ID3) on loop 2.

SD5s & SD7s that only have a single loop fitted can also set to operate on either Loop 1 or Loop 2.

# Index

## Symbols

-10 2-47  
 4:Con 2-55  
 48 2-47  
 9-pin 2-51  
 9-pin Eavesdrop 2-51

## A

Active 2-21  
 Add from CG 2-15  
 Add Snapshots 2-8  
 add to group 2-18  
 afl 2-42  
 all 2-35  
 all mute 2-41  
 all on 1-21  
 alt 1-11  
 assign 2-51  
 assign level to master 2-43  
 Assignable Controls 1-13  
 attack rate 2-31  
 Audio I/O 2-46  
 Audio Sync 2-50  
 Auto Expand Dynamics 2-27  
 Auto Expand EQ 2-27  
 Auto Expand Time 2-27  
 auto solo 1-7, 2-42  
 Auto Update 2-25  
 Auto-cancel 2nd Function 2-27  
 auto-conform all 2-48  
 auto-mute 2-41  
 auto-name 2-48  
 auto-route 2-5  
 Auto-Save Recovery Session 2-32  
 Aux Busses 1-13  
 Aux Mix Presets 1-17  
 Aux Order 2-7  
 Aux Sends on Groups 1-16  
 aux to fader 1-16  
 Aux To Masters 2-27  
 aux to rotary 1-17

## B

balance 1-11  
 band on 1-19  
 Brightness 2-31  
 build gang 2-37  
 button colour 2-12

## C

Caps 1-3  
 Capture 2-24  
 capture 2-52  
 Card/Slot Type 2-48  
 CG Faders control Aux Sends 2-28  
 CG MUTE Indicator 1-9

Channel Dynamics 1-20  
 Channel Filters 1-17  
 Channel List 1-9  
 Channel Name 1-3  
 Channel Names 1-3  
 Channel Processing 2-39  
 Channel Safes 1-4  
 Channel Solos 1-7  
 Channel Types 1-2  
 classic 1-18  
 CLEAR 1-4  
 clear 2-12, 2-42  
 clear all 1-15, 2-5  
 clear all links 1-14  
 Clear Bank 1-25  
 clear macros 2-7  
 Clear Over Indicators 2-4  
 Clear PC 2-23  
 clear snapshots 2-7  
 command types 2-53  
 Confirm 2-17  
 confirm delete 2-9  
 Conform All Ports 2-48  
 connect all 1-15  
 Console Security 2-3  
 Control Group Mute 2-41  
 Copy 1-3  
 Copy Audio 2-49  
 Copy Audio To 2-46  
 Copy Bank From 1-25  
 Copy Bank To 1-25  
 Copy Channels 1-4  
 copy from 1-4  
 copy levels from 1-17  
 copy to 1-6, 2-12  
 Create Multi 1-25  
 Cut 1-3

## D

Date & Time 2-7  
 Default All 2-6  
 Default Positions 2-32  
 delay 2-42  
 Delays 2-30  
 delete files 2-9  
 delete folder 2-9  
 Deleting a Snapshot 2-18  
 Description 2-7  
 Dim LCD buttons 2-31  
 Direct Outputs 1-14  
 Disable 2-30  
 Display Snapshots Overview 2-27  
 Display System Alerts 2-33  
 Display System Status Indicators 2-33  
 Duplicate Selected 2-16  
 duration 2-21  
 Duration Active 2-21



dyn-eq 1-18

dynamic on 1-19

## E

Edit Multi 1-27

edit name 1-7, 2-34

Edit Range 2-17

Editing Multiple Snapshots 2-17

ENABLE CONSOLE NETWORK 2-44

Enable Console Network 2-32

Enable Waves MultiRack 2-32

Engine A/B Switches Audio 2-28

eq-dyn 1-18

Expander 2-45

Ext 1 & Ext 2) 2-56

## F

Fader 0dB Detent 2-28

Fader Assigns Channel 2-28

Fader Banks 2-12

fader starts 2-53

Fader Touch Control 2-28

Feed 2-56

Filename 2-7

Files Menu 2-5

Fire 2-16

fire macro 2-54

Fire Snapshot Sends MIDI 2-22

floating labels 2-51

floating meters 2-43

FOH and Monitors 3-2, 3-3, 3-4, 3-5

FOLD 1-14

Folded Controls 1-26

Frame Rate 2-51

Free 2-28

full control 2-47

Full Mirror 2-45

fx output 1-9

FX Presets 1-10

fx Presets 2-34

## G

GANG 1-9, 1-23, 2-37

Gate Key Route 1-22

Global 2nd Functions 2-27

Global Quick Select 2-27

Global Scope 2-18, 2-20

Global Set To Defaults 2-11

GPI 2-53

GPIO Relays 2-2

Graphic EQ 2-37, 2-39

Graphic EQ ALL 2-38

Graphic EQ Presets 2-38

Group & Auto Update Scope 2-18

Group and Socket Names 2-48

Group Channels 1-14

Group Name 2-48

Group Order 2-7

Group Outputs 1-14

groups of presets 1-6

## H

HARD mute 1-9

headphone 2-43

## I

Initial Cap 1-3

Insert 1-9

insert A 1-8, 1-10

insert B 1-8, 1-10

Insert New 2-16

Insert Routing 1-9

IP address 2-45

isolate 2-47

## J

JOIN CG 1-24, 1-25, 2-39

JOIN/LEAVE 2-39

join/leave 2-40

## K

key 1-22

key listen 1-22

## L

L<>R 1-12

L>L+R 1-12

Large LCD Names 2-27

Layout Menu 2-12

LCD Functions 1-22

link 1-21

link all 1-14

link pans 1-16

Listen Safe 2-50

Listen Source 2-49

Listen To Copied Audio 2-46

Listen to Copied Audio 2-49

Live 2-3

Load 2-7

Load Presets 2-10

Load Session 2-7

Load Startup Session 2-32

lock 1-6, 2-12, 2-34

LR/LCR Blend 1-12

## M

m-s 1-12

Machine Control 2-51

macro name 2-52

Macros 2-51, 2-52

MADI Recorder Setup 2-46

main 1-11

Master button 2-2

Master FX Display 2-34

Master Section 2-1

Matrix Inputs 2-35

Meters 2-31

MIDI (MTC) 2-51

MIDI Devices 2-23

MIDI List 2-22, 2-23

MIDI Machine Control 2-51

- MIDI Program 2-23
  - MIDI Received Fires Snapshots 2-22
  - Mirror From Selected 2-44
  - Mirror image 2-56
  - Mirror To Selected 2-44
  - Mirroring 2-44
  - Mirroring Mode 2-32
  - Module 2: Ducker 1-22
  - mono 1-11, 2-42
  - move 2-12
  - Moving a Snapshot 2-17
  - moving fader 2-40
  - MTC 2-25
  - multi 2-42
  - Multi Channels 1-25
  - Multi-console Setups 3-2
  - multi-input 1-25
  - Multiband Dynamics 1-21, 1-22
  - MUTE 1-9
  - mute only 2-41
- N**
- Network 2-44
  - Network Configuration 2-44
  - new folder 2-9
  - new group 1-7
  - Next 1-3, 2-16
  - No Solo 2-42
  - Non Relative Group Update 2-18
  - Notes Style 2-26
- O**
- Off-line 2-51
  - One Way 2-45
  - OSC 2-53
  - Oscillator 2-2
  - Output Routing 1-12
  - Over Mode 1-19
  - overs hold 2-31
  - Overview Clear 2-4
  - Overview Clear Screen 2-4
  - Overview Display 2-13
- P**
- Partial Load 2-8
  - Paste 1-3
  - peak hold 2-31
  - pfl 2-42
  - Port Control 2-47
  - Port Selection 2-46
  - post fader 2-31
  - Post-Fade Inserts 1-8
  - post-insert eq 1-20
  - post-trim 2-31
  - pre-fader 2-31
  - pre-insert eq 1-20
  - pre-trim 2-31
  - precision 1-18
  - Previous 2-16
  - Protected 2-28
- Q**
- Quit to Windows 2-4
- R**
- R>L+R 1-12
  - Rebuild Banks 2-7
  - recall at 2-21
  - Recall scope 2-20
  - Recalling a Snapshot 2-16
  - receive only 2-47
  - Receive Session From Selected 2-44
  - Relative Group Update 2-18
  - Relative Groups 2-18
  - release rate 2-31
  - Remap All Optocore 3-6
  - Remote 2-45
  - removable USB 2-7
  - Rename 2-17
  - rename file 2-9
  - rename folder 2-9
  - Renaming a Snapshot 2-17
  - ReNUMBER 2-18
  - Renumbering Snapshots 2-18
  - Replace Snapshots 2-8
  - Reset Engine 2-4
  - Reset Surfaces 2-4
  - Restart 2-4
  - Restructure 2-5
  - Rev link pans 1-16
  - Round to whole dBs 2-27
  - RTN To Audio 2-25
- S**
- SAFE 1-4
  - Save 2-9
  - Save As New File 2-9
  - Save Presets 2-10
  - Save Session 2-9
  - Save Startup Session 2-32
  - Scroll Up/Down 2-16
  - Security 2-3
  - select all 2-9
  - Select Channels 2-13
  - Select Range 2-17
  - select range 2-9
  - Self 2-56
  - Send Session To 2-44
  - send+return 1-10, 2-43
  - Session Report 2-11
  - Session Structure 2-5
  - session title 2-5
  - set all sends 1-16
  - Set Backup 2-10
  - Set Date & Time 2-4
  - Set Links 1-14
  - Set Listen Source 2-49
  - Set Live Restrictions 2-3
  - Set Spill 2-15
  - Set Spill Direction 2-28

Setup Optocore 3-6  
Shared 2-47  
Shutdown 2-4  
Shutdown All 2-4  
Signal Overs 2-4  
single 2-42  
Single Engine Only 2-32  
smart keys 2-53  
SMPTE (LTC) 2-51  
Snapshot Control By MIDI 2-22  
Snapshot Crossfades 2-22  
Snapshot GPO Relays 2-24  
Snapshot Groups 2-18  
Snapshot Locked 2-26  
Snapshot Notes 2-26  
Snapshot Recall Times 2-21  
Snapshot Recalls Total Gain 1-10, 3-3  
Snapshot Undo 2-18  
Snapshots 2-16  
Snapshots and MIDI 2-22  
Socket Conforming 2-48  
Socket Display 2-47  
Socket Name 2-48  
Socket Options 2-48  
Solo 1-23, 2-29  
solo 1 1-7  
solo 2 1-7  
Solo As an Input Source 2-43  
Solo Assigns Aux to Faders 2-29  
Solo Assigns Aux to Rotaries 2-29  
Solo Assigns Channel 2-29  
Solo Choice 1-23  
Solo Displays Insert 2-29  
Solo Panel 2-41  
Solo Reverts to Output 2-29  
Status 2-33  
stereo 1-11, 2-42  
Storing a Snapshot 2-16  
subnet mask 2-45  
Surface 2-27  
surface leds 2-31  
Surface Offline 2-25  
swap 2-12  
System Menu 2-2

## T

Talk To Auxes 2-54  
Talkback 2-54, 2-55  
TB Input Route 2-54  
TB Outputs 2-54  
Templates 2-5  
Timecode & Transport 2-50  
Timecode Output 2-51  
Timecode Source 2-51  
Touch Keyboard 2-27  
Touch To Fire 2-16  
touch-turn assignment 2-35  
Track 1-10, 3-3  
Transport Control 2-15

## U

Unattended 2-3  
Under Mode 1-19  
Unfolding Channels 1-14  
update 1-7  
Update Group 2-18

## V

vca style 2-41  
Video Link 2-56

## W

width 1-11

