

# Roland



# STUDIO-CAPTURE

## USB 2.0 AUDIO INTERFACE

Owner's Manual

# Contents

<b>Main Features</b> .....	<b>3</b>
<b>Confirming Package Contents</b> .....	<b>4</b>
<b>Panel Descriptions</b> .....	<b>6</b>
Front Panel .....	<b>6</b>
Rear Panel .....	<b>9</b>
<b>USB Driver Installation</b> .....	<b>11</b>
Install the USB Driver (Windows) .....	<b>11</b>
Install the USB Driver (Mac OS X) .....	<b>13</b>
Confirm that Sound Can Be Heard .....	<b>14</b>
<b>Basic Operation</b> .....	<b>16</b>
Connecting Equipment .....	<b>16</b>
Turning the Power On/Off .....	<b>16</b>
Turning the Power On .....	<b>16</b>
Turning the Power Off .....	<b>17</b>
Making the Power Automatically Turn Off After a Time (Auto Off) .....	<b>17</b>
Checking the Levels .....	<b>18</b>
Adjusting the Audio Signals .....	<b>19</b>
Adjusting the Mic Preamp and Compressor .....	<b>19</b>
Adjusting the Attenuator .....	<b>22</b>
Adjusting the Direct Monitor Settings .....	<b>23</b>
Setting Input and Output Device .....	<b>25</b>
<b>Using the STUDIO-CAPTURE Control Panel</b>	<b>27</b>
Internal Blocks of the STUDIO-CAPTURE	<b>27</b>
Starting the STUDIO-CAPTURE Control Panel .....	<b>29</b>
Controlling the Preamps and Mixers ..	<b>30</b>
Preamp Control Screen .....	<b>30</b>
Attenuator Screen .....	<b>32</b>
Monitor Mixer Control Screen ..	<b>32</b>
Patch Bay .....	<b>37</b>
Saving or Loading Settings on the Computer .....	<b>38</b>
Saving or Loading Compressor Presets on the Computer .....	<b>38</b>
Changing the AUTO-SENS Settings ..	<b>39</b>

Directly Outputting Each Channel's Input .....	<b>40</b>
Synchronizing with Other Devices ..	<b>41</b>
Initializing the Settings .....	<b>41</b>
Checking the Signal Flow .....	<b>41</b>
USB Driver Settings .....	<b>42</b>
View in Foreground .....	<b>42</b>

---

## **Changing the System Settings** .....

---

## **Advanced Operation** .....

Outputting to Four Monitor Systems ..	<b>45</b>
Connecting Two STUDIO-CAPTURE Units .....	<b>46</b>
Synchronizing with Another Digital Device .....	<b>52</b>

---

## **Appendices** .....

Sampling Rate Setting .....	<b>53</b>
Limitations When Using the 192 kHz Setting .....	<b>53</b>
Restoring the Factory Settings (Factory Reset) .....	<b>54</b>
USB Driver Settings .....	<b>54</b>
Mac OS X MIDI Settings .....	<b>56</b>
Troubleshooting .....	<b>59</b>
USB Driver Installation .....	<b>59</b>
Using the STUDIO-CAPTURE ..	<b>60</b>
Problems When Two Units Are Connected .....	<b>66</b>
Changing Computer Settings to Avoid Problems .....	<b>68</b>
Setting the System Volume .....	<b>68</b>
Voice Communication Software Settings .....	<b>69</b>
Monitoring Function Settings ..	<b>69</b>

---

## **Main Specifications** .....

---

## **USING THE UNIT SAFELY** .....

---

## **IMPORTANT NOTES** .....

---

## **Index** .....

# Main Features

## Simultaneously input 16 channels and output 10 channels

At 96/48/44.1 kHz, you can simultaneously input 16 channels and output 10 channels.

This allows you to use multi-mic setups to record acoustic drums or a band.



## Twelve mic preamps allow recording with high audio quality

The STUDIO-CAPTURE comes equipped with twelve of the highly acclaimed "VS PREAMP" mic preamps, which were designed to provide the highest possible sound quality when they were introduced on the OCTA-CAPTURE.

Despite its compact body, the STUDIO-CAPTURE can capture the true sound of your instruments and mics with astoundingly high audio quality.

A wide range of inputs are supported, and you can also connect a guitar.



## AUTO-SENS automatically sets the optimal input level

The analog input jacks offer AUTO-SENS, which analyzes an instrument's volume and automatically sets the optimal input level.

After AUTO-SENS is turned ON, the input signal's volume changes are analyzed during a rehearsal for a fixed length of time, allowing the signal to be recorded on your DAW software at the optimal level. This is convenient for recording sessions with limited setup time, and lets you avoid problems such as clipping due to inappropriate input level settings.



## Low-latency monitoring

The STUDIO-CAPTURE uses the same "VS STREAMING" audio streaming technology that won broad acclaim when it was introduced on the OCTA-CAPTURE. Thanks to a high degree of fusion between the driver and the hardware, we have been able to keep monitoring latency during recording to an ultra-low level, and ensure stable operation for the system.



## Dedicated software allows settings from your computer

The dedicated "STUDIO-CAPTURE Control Panel" software lets you edit all of the parameters. (Parameters not shown in the display of the STUDIO-CAPTURE can also be edited.)



Before using this unit, carefully read the sections entitled "USING THE UNIT SAFELY" (p. 72) and "IMPORTANT NOTES" (p. 75). These sections provide important information concerning the proper operation of the unit. Additionally, in order to feel assured that you have gained a good grasp of every feature of your new unit, read Owner's Manual in its entirety. This manual should be saved and kept on hand as a convenient reference.

# Confirming Package Contents

After you open the package, please check that all items are present.

If anything is missing, please contact the retailer from whom you purchased the unit.

## STUDIO-CAPTURE

## STUDIO-CAPTURE Driver CD-ROM

Contains USB drivers, and demo songs.

## AC adaptor

This is the dedicated AC adaptor for the STUDIO-CAPTURE.

## USB cable

Use this cable to connect the STUDIO-CAPTURE to the USB port of your computer.

\* Please use only the included AC adaptor and USB cable. If you require a replacement due to loss or damage, please contact the nearest Roland Service Center, or an authorized Roland distributor, as listed on the "Information" page.

## Owner's Manual

This is the document you're reading. Keep it on hand for reference when needed.

## Block Diagram leaflet

This shows the audio signal flow, and how the preamp (p. 30), monitor mixer (p. 32), and patch bay (p. 37) are related.

## License agreement

This agreement permits you to use software for which the copyright is owned by Roland Corporation.

You must read this before opening the CD-ROM.



## Confirming Package Contents

### □ Rack mount angle

If you want to install the STUDIO-CAPTURE in an 19-inch rack, please use the included rack mount adaptors.

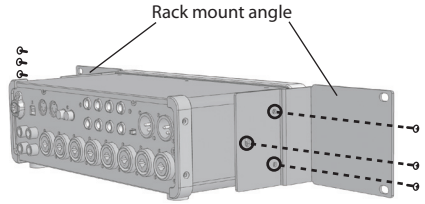

### Installation

1. Remove the screws from the left and right sides of the STUDIO-CAPTURE (three screws on each side).
2. Fasten the rack mount adaptors to the STUDIO-CAPTURE using the screws you removed in step 1.

Be sure to attach the rack mount adaptors using the screws you removed.

### Items you'll need to prepare

- External amplifier, speakers, headphones, etc., for listening to the sound that is output from the STUDIO-CAPTURE
- Microphone, guitar, etc., for inputting audio to the STUDIO-CAPTURE

# Panel Descriptions

## Front Panel

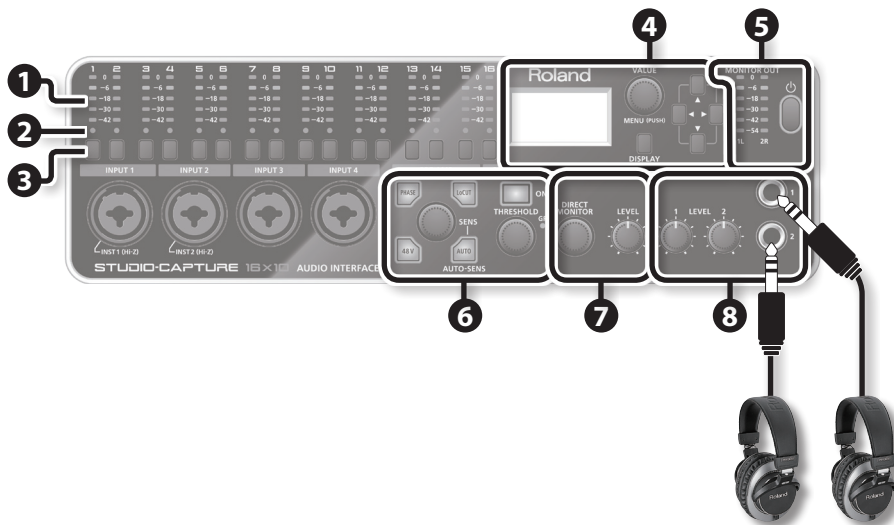

Number	Name	Explanation
<b>1</b>	Input level meters	These indicate the input levels of the 16 channels. Adjust the input level so that the peak indicator (0; red LED) of each input level meter does not light.
<b>2</b>	Input channel indicators	These indicate the selected channel. You can edit the preamp settings of the channel whose indicator is lit.
<b>3</b>	Input channel buttons	Press the button of the input channel for which you want to edit preamp, compressor, or attenuator settings (p. 19, p. 22).
<b>4</b>	Display	This shows various information about the STUDIO-CAPTURE.
	[VALUE] knob ([MENU] button)	Turn this knob to edit the parameter value. If you press this knob, the SYSTEM screen (p. 43) appears in the display.
	[DISPLAY] button	The main screen (p. 18) appears in the display.
	Cursor [▲] [▼] [◀] [▶] buttons	These buttons move the cursor in the display.
<b>5</b>	MONITOR OUT level meter	This indicates the level of the audio signal immediately before the [MONITOR OUT LEVEL] knob (refer to the separate "Block Diagram" leaflet).
	[⏻] (Power) button	To turn the power on/off, hold down the [⏻] (power) button for several seconds (p. 16).

## Panel Descriptions

Number	Name	Explanation
6	Here you can make settings for the preamp and compressor of the input channel whose input channel indicator is lit (p. 19–p. 22).	
	[SENS] knob	Adjusts the preamp gain of the input channel (p. 20).
	[AUTO-SENS] button	Automatically sets the level optimally for the audio input signal (p. 20).
	[PHASE] button	Inverts the polarity of the audio input signal (p. 20).
	[LoCUT] button	Applies a low-cut filter to the audio input signal (p. 20).
	[48V] button	Supplies phantom power to the input channel (p. 20). Turn this on if phantom power is required, such as when a condenser mic is connected.
	[COMPRESSOR] button	Applies a compressor to the audio input signal (p. 22).
	[THRESHOLD] knob	Adjusts the level at which the compressor is applied (p. 22).
	GR indicator	This will light when the compressor is being applied.
7	[DIRECT MONITOR] knob	Adjusts the level of the audio signal that is output from the input channel mixer (DIRECT MONITOR; refer to the separate “Block Diagram” leaflet).
	[MONITOR OUT LEVEL] knob	Adjusts the level of the audio signals that are output from MONITOR OUT 1L and 2R (LINE OUT 1L and 2R jacks) (refer to the separate “Block Diagram” leaflet).
8	[PHONES LEVEL 1], [PHONES LEVEL 2] knobs	The [PHONES LEVEL 1] and [PHONES LEVEL 2] knobs adjust the level of the audio signals that are output from the PHONES 1 and 2 jacks, respectively.
	PHONES 1, 2 jacks	You can connect headphones to these jacks.

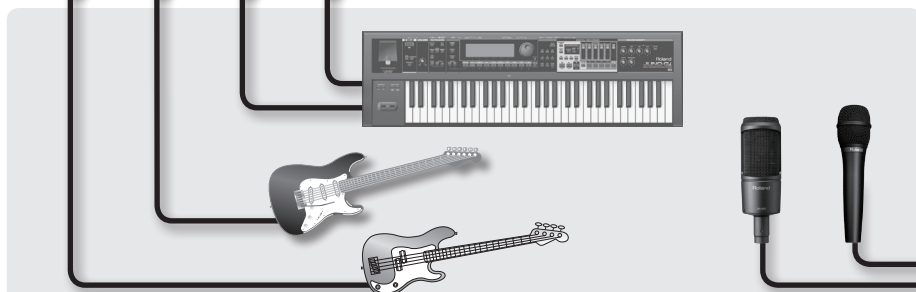
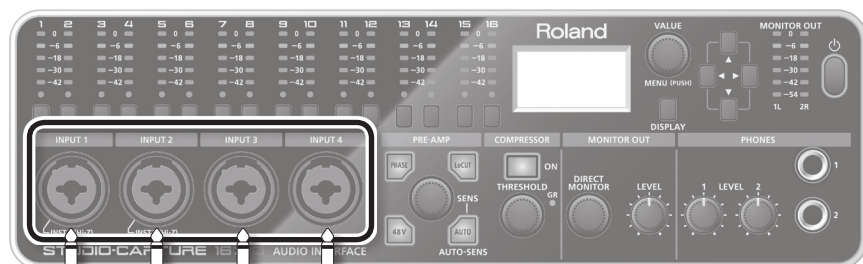

\* The explanations in this manual include illustrations that depict what should typically be shown by the display. Note, however, that your unit may incorporate a newer, enhanced version of the system (e.g., includes newer sounds), so what you actually see in the display may not always match what appears in the manual.

# Panel Descriptions



## INPUT 1–12 jacks

These are analog input jacks equipped with mic preamps. Either balanced or unbalanced sources can be connected.

<b>Guitar Bass</b>	Connect to either INPUT 1 or 2, and turn Hi-Z on (p. 20).	
<b>Condenser microphone</b>	Connect using a balanced (XLR) plug and turn on the [48V] button (p. 20). (Phantom power is not supplied to phone plugs.)	
<b>Dynamic microphone</b>	Turn off the [48V] button (p. 20) and connect using a balanced (XLR) plug. * The [48V] button must be turned off. * You must use an XLR plug when connecting a mic.	

Howling could be produced depending on the location of microphones relative to speakers. This can be remedied by:

1. Changing the orientation of the microphone(s).
2. Relocating microphone(s) at a greater distance from speakers.
3. Lowering volume levels.

## Rear Panel

### INPUT 13–16 jacks

These are analog audio input jacks. Either balanced or unbalanced sources can be connected.

### COAXIAL IN (15/16) jack

Here you can connect a device that is able to transmit digital audio signals. Alternatively, you can connect an additional STUDIO-CAPTURE unit (p. 46).

### MONITOR OUT 1L, 2R jacks

Connect a mixer or other device here.

### [MONITOR OUT LEVEL] switch

If this is "ON," the [MONITOR OUT LEVEL] knob **7** will be enabled.

If this is set to "BYPASS," the audio signal unaffected by the [MONITOR OUT LEVEL] knob will be output.

For details, refer to the separate "Block Diagram" leaflet.

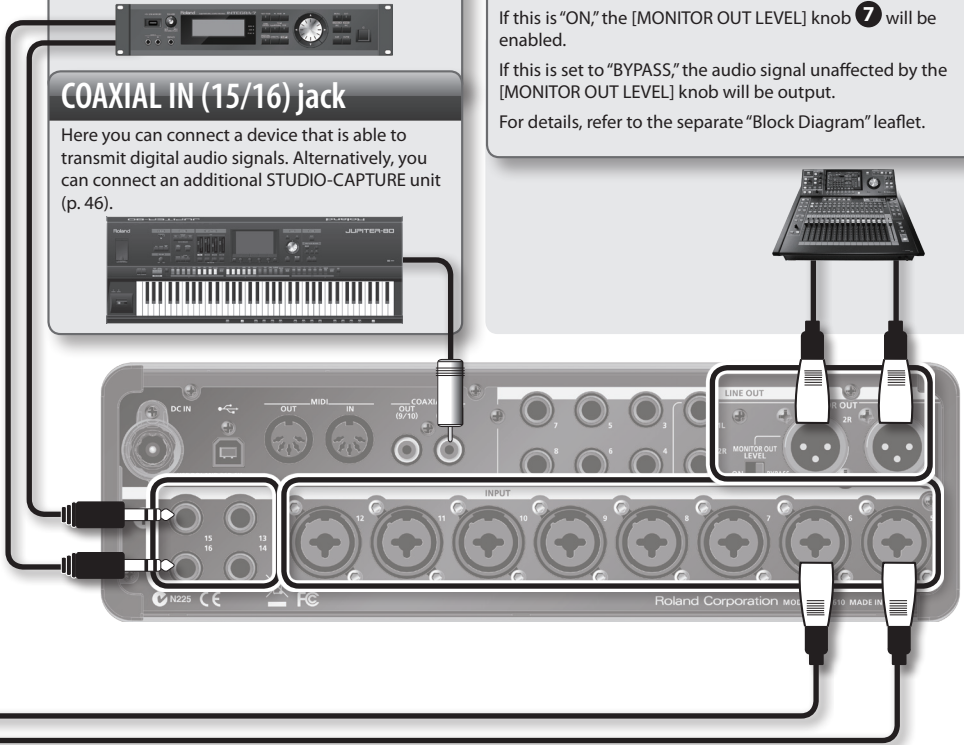

This instrument is equipped with balanced (XLR/TRS) type jacks. Wiring diagrams for these jacks are shown below. Make connections after first checking the wiring diagrams of other equipment you intend to connect.

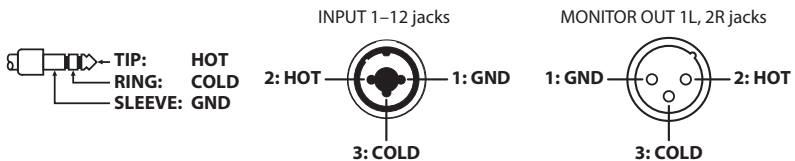

# Panel Descriptions

## DC IN jack

Connect the included AC adaptor.

Place the AC adaptor so the side with the indicator (see illustration) faces upwards and the side with textual information faces downwards.

\* The indicator will light when you plug the AC adaptor into an AC outlet.

AC Outlet

Power Cord

## MIDI IN, OUT connectors

Connect the MIDI OUT connector to an external MIDI sound module, etc.

Connect the MIDI IN connector to a MIDI keyboard or MIDI controller.

## COAXIAL OUT (9/10) jack

Connect a device that is able to receive digital audio signals, such as a speaker equipped with digital input. Alternatively, you can connect an additional STUDIO-CAPTURE unit (p. 46).

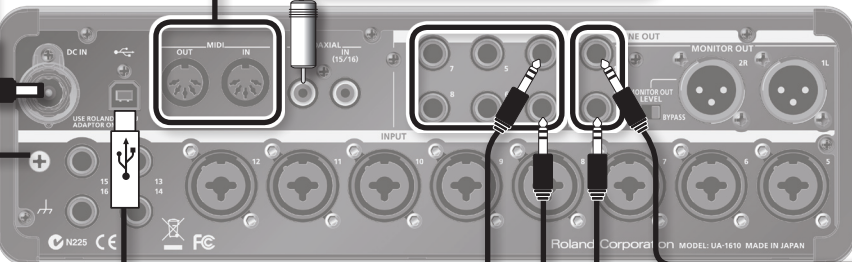

## USB port

Connect this to a computer that supports USB 2.0.

Install the USB driver before you make this connection (p. 11).

## Ground terminal

Refer to "Grounding" (p. 76).

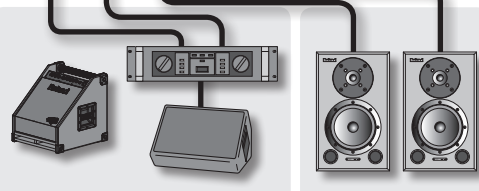

## LINE OUT 1L, 2R, 3-8 jacks

Connect these to devices that are able to receive analog audio signals, such as amplified speakers.

MONITOR OUT will be output to the LINE OUT 1L and 2R jacks.

If you're capturing a band performance and want a different monitor balance for each performer, connect monitor speakers to the LINE OUT 3-8 jacks as well (p. 45).

# USB Driver Installation

A USB driver is software installed on your computer that handles data sent between your computer's software and the STUDIO-CAPTURE.

In order to use the STUDIO-CAPTURE with a computer, the USB driver must be installed.

## NOTE

Do not connect the STUDIO-CAPTURE to the computer until you are directed to do so.

## MEMO

Refer to the Roland website for the latest USB drivers and information about compatibility with the latest operating system versions.

<http://www.roland.com/support/>

## Install the USB Driver (Windows)

**1. Connect the AC adaptor (p. 10).**

**2. Start up the computer without the STUDIO-CAPTURE connected.**

Exit all applications that are running.

### Windows 8

Switch to the "Desktop."

**3. Insert the included "STUDIO-CAPTURE Driver CD-ROM" into the DVD-ROM drive.**

**4. Double-click the [Setup] icon in the [WinDriver] folder on the CD-ROM.**

The installer starts.

**5. Follow the instructions on the screen and install the software.**

**5-1.** When a confirmation screen regarding user account control appears, click the [Yes] button or [Continue] button.

**5-2.** When "The STUDIO-CAPTURE Driver will be installed on your computer." appears, click the [Next] button.

**5-3.** Click the [Next] button again.

## MEMO

- If a dialog box regarding Windows security appears, click the [Install] button.
- If the "Software Install" dialog box appears, click the [Continue] button.

# USB Driver Installation

- When “Ready to install the driver.” appears, connect the STUDIO-CAPTURE to the computer using the USB cable, and then hold down the [⏻] (power) button for several seconds to turn on the power.

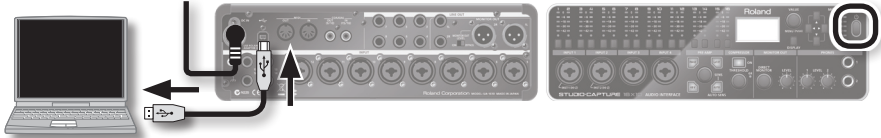

### MEMO

If a message appears, follow the instructions on the screen.

### Windows XP

If using Windows XP, follow the instructions on the screen and continue the installation.

- If a dialog box that asks whether you want to connect to Windows Update appears, select the [No, not this time] button and click the [Next] button.
- Select the [Install the software automatically (Recommended)] button and click the [Next] button.
- If the “Hardware Installation” dialog box appears, click the [Continue Anyway] button.
- When “Completing the Found New Hardware Wizard” appears, click the [Finish] button.



- When “Installation has been completed.” appears, click the [Close] button.

The installer exits.

### MEMO

If the “Change System Settings” dialog box appears, click the [Yes] button. Windows restarts.



## Install the USB Driver (Mac OS X)

- 1. Connect the AC adaptor (p. 10).**
- 2. Start up the computer without the STUDIO-CAPTURE connected.**  
Exit all applications that are running.
- 3. Insert the included “STUDIO-CAPTURE Driver CD-ROM” into the DVD-ROM drive.**
- 4. Double-click the [StudioCapture\_USBDriver] icon in the [MacDriver] folder on the CD-ROM.**  
The installer starts.  
If a dialog box requesting a password appears during installation, enter a computer administrator’s user name and password and click the [Install Software] button or [OK] button.
- 5. Follow the instructions on the screen and install the software.**
  - 5-1. When “Welcome to the STUDIO-CAPTURE Driver installer” appears, click the [Continue] button.
  - 5-2. If the screen for selecting the installation destination appears, select the startup disk and click the [Continue] button.
  - 5-3. When the installation type appears, click the [Install] button or [Upgrade] button.
  - 5-4. Click the [Continue Installation] button in the next screen.
  - 5-5. When installation has finished, click the [Restart] button.
- 6. Once your computer has started, use a USB cable to connect the STUDIO-CAPTURE to the computer, and then hold down the [⏻] (power) button for several seconds to turn on the power.**

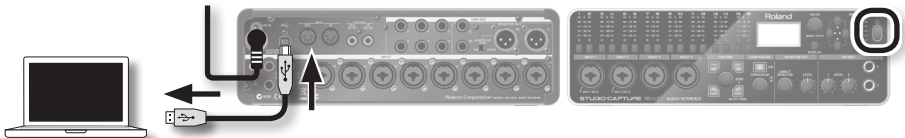

### MEMO

Refer to “Mac OS X MIDI Settings” (p. 56) if you intend to use MIDI.

## Confirm that Sound Can Be Heard

Configure the computer so that audio played from a program that uses the computer's audio features, such as Music (Windows 8 app), Windows Media Player or iTunes, can be heard.

### 1. Connect the headphones or amplified speakers (p. 7, p. 10).

\* To prevent malfunction and equipment failure, always turn down the volume, and turn off all the units (except the computer) before making any connections.

### 2. Use the following procedure to select the "STUDIO-CAPTURE" as the system audio output device.

#### Windows 8/Windows 7/Windows Vista

- 2-1. Open the "Control Panel," click the [Hardware and Sound] icon, and then click the [Sound] icon. If you have selected Icon view or Classic view, double-click the [Sound] icon.
- 2-2. Click the [Playback] tab, select the STUDIO-CAPTURE's [1-2], and then click the [Set Default] button.
- 2-3. Click the [OK] button.

#### Windows XP

- 2-1. Open the "Control Panel," click the [Sounds, Speech, and Audio Devices] icon, and then double-click the [Sounds and Audio Devices] icon. If you have selected Classic view, double-click the [Sounds and Audio Devices] icon.
- 2-2. Click the [Audio] tab and select [1-2 (STUDIO-CAPTURE)] in the [Sound playback] area. When connecting the external MIDI sound module, select [STUDIO-CAPTURE] in the [MIDI music playback] area.
- 2-3. Click the [OK] button.

#### Mac OS X

- 2-1. Open "System Preferences" and click the [Sound] icon.
- 2-2. Click the [Output] tab and select [STUDIO-CAPTURE].
- 2-3. When you have finished making these settings, quit "System Preferences."

### 3. Open the folder named [Sample] on the included CD-ROM, and copy the file "TTears (.mp3)" to the desktop.

### 4. Double-click the file "TTears (.mp3)" that you copied to the desktop.

Music (Windows 8 app), Windows Media Player or iTunes starts.  
Click the playback button to play the sample file.

### MEMO

- The software that starts and is used to play the sample file may vary depending on your computing environment. If different software starts, play the sample file as described in the owner's manual for the software you are using.
- If you cannot select "STUDIO-CAPTURE" in step 2-2, refer to "Using the STUDIO-CAPTURE" (p. 60).
- If the STUDIO-CAPTURE is selected as the output device, the computer's audio alerts will be played using the STUDIO-CAPTURE; they will not be heard from the computer's speakers.

### To open the Control Panel Windows 8

- 1. On the Start screen, click the Desktop.**
- 2. Move the mouse pointer to the upper right or lower right corner of the screen to display the charms.**  
\*On touch-enabled PCs, swipe from the right side of the screen to display the charms.
- 3. Click [Settings] and display the "Settings charms."**
- 4. In "Settings charms," click [Control Panel] to open the "Control Panel."**

# Basic Operation

## Connecting Equipment

Connect guitars and mics to the INPUT jacks, and amplified speakers to the LINE OUT 1L and 2R jacks. Headphones can be connected to the PHONES 1 jack and PHONE 2 jack (p. 6–p. 10).

## Turning the Power On/Off

- \* Before you proceed, you must install the USB driver on your computer (p. 11).
- \* Once everything is properly connected (p. 6–p. 10), be sure to follow the procedure below to turn on their power. If you turn on equipment in the wrong order, you risk causing malfunction or equipment failure.

## Turning the Power On

1. Turn the [MONITOR OUT LEVEL] knob and [PHONES LEVEL 1] [PHONES LEVEL 2] knobs all the way to the left.
2. Connect the STUDIO-CAPTURE to the computer using the USB cable.
3. Switch on the power to any external equipment connected to the input jacks.
4. Press and hold the STUDIO-CAPTURE's [⏻] (Power) button for several seconds, and then release it.
  - \* This unit is equipped with a protection circuit. A brief interval (a few seconds) after turning the unit on is required before it will operate normally.
  - \* Before turning the unit on/off, always be sure to turn the volume down. Even with the volume turned down, you might hear some sound when switching the unit on/off. However, this is normal and does not indicate a malfunction.
5. Switch on the power to your amp or powered monitor speakers.
6. During playback, adjust the volume by turning the [MONITOR OUT LEVEL] knob and [PHONES LEVEL 1] [PHONES LEVEL 2] knobs toward the right.

## Turning the Power Off

Before you turn off the power, make sure to do the following.

- Turn the [MONITOR OUT LEVEL] knob and [PHONES LEVEL 1] [PHONES LEVEL 2] knobs all the way to the left
- Minimize the volume of all connected equipment

1. Switch off the power to your amp or powered monitor speakers.
2. Press and hold the STUDIO-CAPTURE's [⏻] (Power) button for several seconds, and then release it.

The next time you turn the power on, the unit will start up with the settings that were in effect when it was powered off.

3. Switch off power to the connected equipment.

## Making the Power Automatically Turn Off After a Time (Auto Off)

When not connected to a computer, the STUDIO-CAPTURE will automatically be switched off four hours after you stop playing or operating it (if the factory settings have been unmodified). If you don't want the unit to turn off automatically, change the "AUTO-OFF" setting to "OFF" as described below.

### NOTE

- Any settings that you are in the process of editing will be lost when the power is turned off. If you have any settings that you want to keep, you should save them beforehand.
- To restore power, turn the power on again.

### MEMO

Auto Off will not function if the STUDIO-CAPTURE is connected to your computer, or if a microphone/instrument is connected.

1. Press the [VALUE] knob ([MENU] button) to access the SYSTEM screen.
2. Use the [▲] [▼] buttons to choose "AUTO-OFF:"
3. Turn the [VALUE] knob to choose "4HOURS" or "OFF."

Value	Explanation
OFF	The power will not turn off automatically.
4HOURS (default)	When not connected to a computer/microphone/instrument, the STUDIO-CAPTURE will automatically be switched off four hours after you stop operating it.

4. Press the [DISPLAY] button to return to the main screen (p. 18).

## Checking the Levels

The output levels are shown in the main screen.

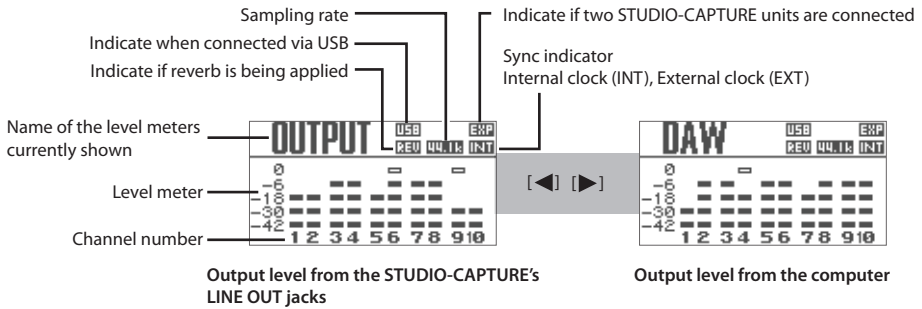

### MEMO

- If you press the [DISPLAY] button from other screens, you'll switch to this main screen.
- In the main screen, press the [▼] button to access the MIX A screen (p. 24).

# Adjusting the Audio Signals

## Adjusting the Mic Preamp and Compressor

Each INPUT 1–12 jack has its own mic preamp and compressor which can be adjusted independently.

### 1. Select the channel that you want to set

Press the input channel button (1–12) of the channel that you want to set; the input channel indicator will light. The display will show the preamp screen.

You can press the [DISPLAY] button to return to the main screen.



#### MEMO

To select multiple channels (Range Select function), simultaneously press the first and last input channel buttons.

The display will show the first channel number and “-”.

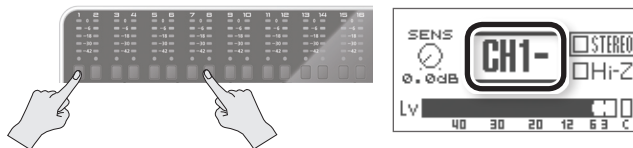

In this example, channels 1–8 are selected.

## Basic Operation

### 2. Adjusting the mic preamp

#### Phase setting

If you want to invert the phase of the audio input signal, press the [PHASE] button so it's lit.

#### Low-cut on/off

To apply the low-cut filter, press the [LoCUT] button so it's lit.

The cutoff frequency is 75 Hz.



#### Hi-Z on/off

\* This function is for the INPUT 1 and 2 jacks.



Turn the [VALUE] knob to switch the input impedance.

Device	Hi-Z
Guitar/Bass	On
Mic, etc.	Off

#### Phantom power on/off

To supply phantom power, press the [48V] button so it's lit.

Turn this on if you're using a condenser mic.

\* Leave the [48V] button off if you're connecting a device that does not support phantom power. Supplying phantom power to such a device will cause malfunction.

#### Adjusting the sensitivity

Turn the [SENS] knob to adjust the input gain so that the peak indicator (0; red LED) of the input level meter does not blink.

#### Auto-sens

If you use AUTO-SENS, the input level will be automatically set according to the highest level of the audio input signal (p. 21).



#### To clear the lit peak indicators

Turn the [VALUE] knob or press any of the following buttons: input channel buttons, [MENU], cursor [▲] [▼] [◀] [▶], or [DISPLAY].







### Using AUTO-SENS

1. Press the [AUTO-SENS] button; it will blink.
2. While the button is blinking, perform the loudest portion of the song.  
If you decide to cancel, press the [DISPLAY] button.
3. Stop performing.

There is no input for approximately four seconds, then the [AUTO-SENS] button will change from rapid blinking to being unlit, and you'll exit this setting.

**MEMO**

If you want to change the maximum recording level setting used by AUTO-SENS, or if you want to manually exit AUTO-SENS, you can make these changes in the SYSTEM screen (p. 39).



### Checking the phantom power on/off status for each jack

If you press and hold the [48V] button, you'll see the phantom power on/off status for each of the INPUT 1–12 jacks.

To switch phantom power on/off, continue holding the [48V] button and press the corresponding input channel button.

+48V											
1	2	3	4	5	6	7	8	9	10	11	12
□	□	□	□	□	□	□	□	□	□	□	□

\* This also works for the [PHASE], [LoCUT], and [COMPRESSOR] buttons.

## Basic Operation

### 3. Adjusting the compressor

#### Turning the compressor on/off

If you want to compress the high levels and boost the low levels to make the volume consistent and avoid distortion, press the [COMPRESSOR] button so it's lit.

When the compressor is applied, the GR indicator will light.

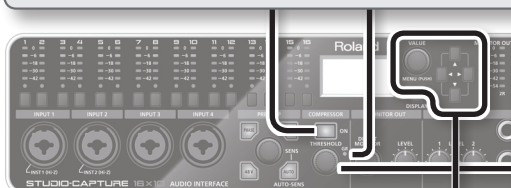

#### Adjusting threshold

Turn the [THRESHOLD] knob to adjust the THRESHOLD setting.

#### Adjusting other parameters (p. 31)

Use the cursor [ $\blacktriangle$ ] [ $\blacktriangledown$ ] [ $\blacktriangleleft$ ] [ $\blacktriangleright$ ] buttons and the [VALUE] knob to adjust the parameters.

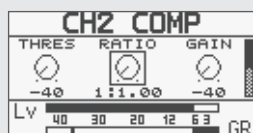

## Adjusting the Attenuator

An attenuator is provided for each of the INPUT 13–16 jacks, allowing you to boost or cut each audio signal independently.

### 1. Select the channel that you want to set

Press the input channel button (13–16) of the channel that you want to set; the input channel indicator will light. The display will show the attenuator screen.



## 2. Adjusting the input channel

**Auto-sens**  
If you use AUTO-SENS, the input level will be automatically set according to the highest level of the audio input signal (p. 21).

**Adjusting the nominal input rating**  
Turn the [SENS] knob to adjust the input attenuator so that the peak indicator (0; red LED) of the input level meter does not blink.

**AUTO-SENS MANUAL**

1	2	3	4	5	6	7	8	9	10	11	12	13	14	15	16
0	0	0	0	0	0	0	0	0	0	0	0	0	0	0	0

## Adjusting the Direct Monitor Settings

On the STUDIO-CAPTURE, the audio signals being input via the INPUT jacks can be output for monitoring without sending them through your computer (direct monitoring). A stereo mixer is provided for you to specify the balance by adjusting the level and pan individually.

**MEMO**

You can also use the STUDIO-CAPTURE Control Panel (p. 27) to do the following things.

- You can adjust the balance of not only the audio signals received at the INPUT jacks but also the balance of sound played back from your computer.
- There are four mixers, allowing you to create four monitor mixes, each with their own balance, as described in "Outputting to Four Monitor Systems" (p. 45)

In the main screen, press the [▼] button to access the MIX A screen.

# Basic Operation

Main screen

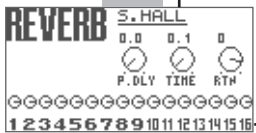
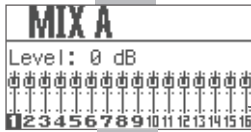
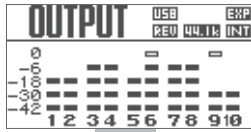

Reverb type  
P.DLY: Pre delay  
TIME: Reverb type  
RTN: Reverb return  
Reverb send

Use the [◀] [▶] cursor buttons to switch input channels, and use the [VALUE] knob to change the value.

Use the [▲] [▼] [◀] [▶] buttons to move the cursor, and use the VALUE knob to change the value.  
For more about reverb, refer to "Reverb" (p. 35).

You can also turn the [DIRECT MONITOR] knob to adjust the overall level of all direct monitoring.



Stereo link  
Mute clear  
Solo clear  
Output level of the input mixer

Use the [▲] [▼] [◀] [▶] buttons to move the cursor, and use the VALUE knob to change the value.

## Setting Input and Output Device

### Precautions concerning the use of DAW software

- Connect the STUDIO-CAPTURE to the computer before starting the DAW software.
- Do not disconnect the STUDIO-CAPTURE from the computer while the DAW software is running. After exiting the DAW software, disconnect the STUDIO-CAPTURE.
- Select the STUDIO-CAPTURE for the DAW software's audio device setting.

Configure the settings necessary to use the DAW software to play audio and MIDI, and to record audio.

Select the STUDIO-CAPTURE as the audio and MIDI input device, and as the output device. For details about settings, refer to the documentation for your software.

### Audio output device

Device name	WDM, MME/KS	ASIO	44.1, 48, 96 kHz	192 kHz
STUDIO-CAPTURE	1-2 (STUDIO-CAPTURE)	OUT 1-2	✓	✓
		OUT 1-2 (2)		
	3-4 (STUDIO-CAPTURE)	OUT 3-4	✓	✓
		OUT 3-4 (4)		
	5-6 (STUDIO-CAPTURE)	OUT 5-6	✓	—
		OUT 5-6 (6)		
	7-8 (STUDIO-CAPTURE)	OUT 7-8	✓	—
		OUT 7-8 (8)		
	9-10 (STUDIO-CAPTURE)	9-10	✓	—
		9-10 (10)		

## Basic Operation

### Audio input device

Device name	WDM	ASIO	44.1, 48, 96 kHz	192 kHz
STUDIO-CAPTURE	1-2 (STUDIO-CAPTURE)	IN 1-2	✓	✓
		IN 1-2 (2)		
	3-4 (STUDIO-CAPTURE)	IN 3-4	✓	✓
		IN 3-4 (4)		
	5-6 (STUDIO-CAPTURE)	IN 5-6	✓	✓
		IN 5-6 (6)		
	7-8 (STUDIO-CAPTURE)	IN 7-8	✓	✓
		IN 7-8 (8)		
	9-10 (STUDIO-CAPTURE)	IN 9-10	✓	—
		IN 9-10 (10)		
	11-12 (STUDIO-CAPTURE)	IN 11-12	✓	—
		IN 11-12 (12)		
	13-14 (STUDIO-CAPTURE)	IN 13-14	✓	—
		IN 13-14 (14)		
	15-16 (STUDIO-CAPTURE)	IN 15-16	✓	—
		IN 15-16 (16)		
MONITOR (STUDIO-CAPTURE)	MONITOR	✓	—	
	MONITOR (R)			

### MIDI output device/MIDI input device

Device name	MIDI port name
STUDIO-CAPTURE	STUDIO-CAPTURE

# Using the STUDIO-CAPTURE Control Panel

## Internal Blocks of the STUDIO-CAPTURE

In addition to its audio interface, the STUDIO-CAPTURE internally contains 12 **preamps**, 4 **attenuators**, 4 **monitor mixers**, and a **patch bay**.

These preamps, attenuators, monitor mixers, and patch bay can be controlled from a special control panel installed on your computer (p. 29).

The STUDIO-CAPTURE Control Panel is automatically installed when you install the USB driver.

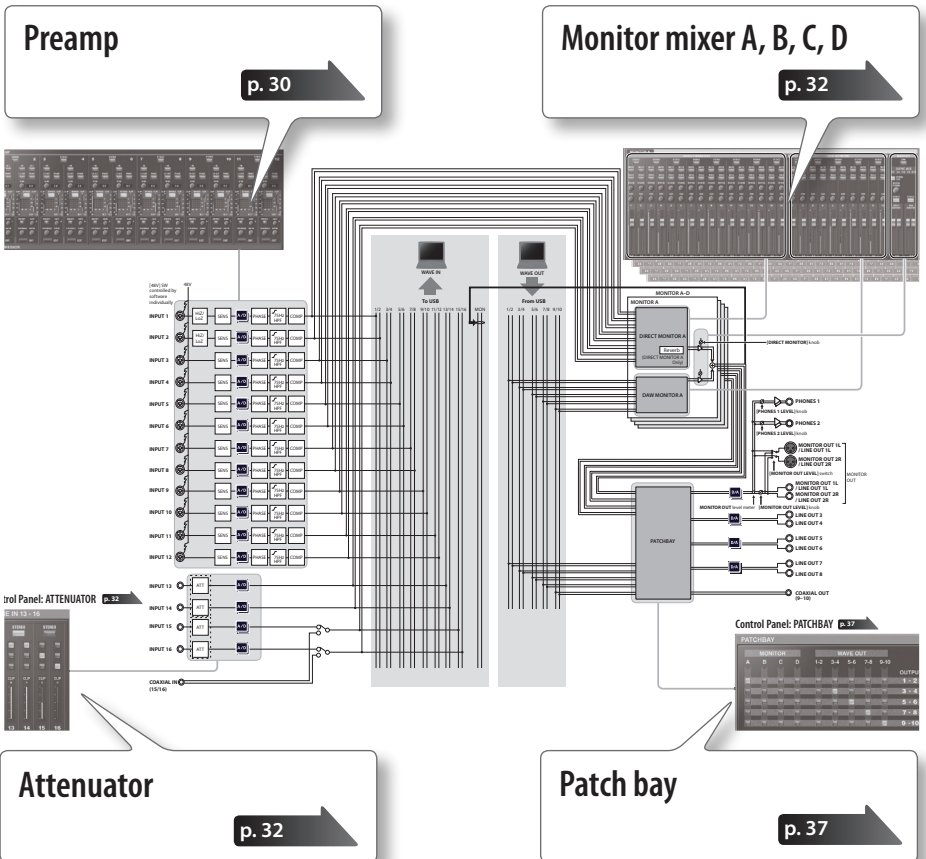

For details on the block diagram, refer to the separate "Block Diagram" leaflet.

# Using the STUDIO-CAPTURE Control Panel

---

## MEMO

Some of the settings, such as those for the preamps, can be controlled by the knobs and buttons of the STUDIO-CAPTURE itself (p. 19).

## Preamps

You can set the input sensitivity for each of the INPUT 1–12 jacks. You can also set the input sensitivity automatically.

Phantom power is also supported. Since it can be switched on/off individually for each channel, you are free to use mixed setups that contain both dynamic mics and condenser mics.

In addition, the various parameters such as the low-cut and phase of each channel can be digitally controlled.

For details, refer to “Preamp Control Screen” (p. 30).

## Attenuators

Each of the INPUT 13–16 jacks lets you attenuate the incoming audio signal, allowing you to adjust the input level. Attenuator settings can also be made automatically.

For details, refer to “Attenuator Screen” (p. 32).

## Monitor mixers A, B, C, D

This allows the input signals to be directly output for monitoring without being routed through the computer. You can adjust the balance among these signals and the playback from the computer.

The direct mixer is a queue mixer that provides individual adjustment of volume and pan for each input and each playback channel from the computer.

You can control the four mixers independently.

For details, refer to “Preamp Control Screen” (p. 30).

## Patch bay

This allows you to assign the output destinations of the four monitor mixers and the output destinations of the playback channels from the computer.

For details, refer to “Patch Bay” (p. 37).



# Starting the STUDIO-CAPTURE Control Panel

Access the STUDIO-CAPTURE Control Panel as follows.

### Windows 8

Display the “Start” screen and click [STUDIO-CAPTURE].

- \* On the “Start” screen, if [STUDIO-CAPTURE] does not exist, then open the “Control Panel,” switch “View by:” to the icon view (Large icons or Small icons).

### Windows 7/Windows Vista/Windows XP

Click the Windows [Start], then successively click [Roland], [STUDIO-CAPTURE Driver], and [STUDIO-CAPTURE].

- \* If you don’t see the STUDIO-CAPTURE icon, open the “Control Panel” and switch to Icon view (Windows 7) or Classic view (Windows Vista/Windows XP).

### Mac OS X

Open the “Applications” folder, and double-click the [STUDIO-CAPTURE Control Panel] icon.

### MEMO

For more about using the STUDIO-CAPTURE Control Panel, you can also choose “View README” from the STUDIO-CAPTURE Control Panel.

<b>Windows version</b>	From the “Driver” menu, choose “Show README”
<b>Mac OS X version</b>	From the “STUDIO-CAPTURE Control Panel” menu, choose “Show README”

# Using the STUDIO-CAPTURE Control Panel

## Controlling the Preamps and Mixers

### Preamp Control Screen

Switch to the monitor mixer control screen (p. 32).

Show the attenuator screen (p. 32).



Preamp control

Refer to "Device panel" (p. 36).

### Preamp

You can control these settings individually for each input jack.

If this is on, sensitivity and compressor settings will be linked in stereo (refer to the column on p. 33).

Supplies phantom power (p.20). Turn this on if you're using a device that requires phantom power, such as a condenser mic.

Enables the low cut filter for the input (p. 20). The cutoff frequency is 75 Hz.

Adjusts the input signal's gain over a range of 0–58 dB, in steps of 0.5 dB.

Click this to open the AUTO-SENS screen (p. 20). Select the channel for which you want to execute Auto-Sens, input an audio signal, and finally click [FINISH].

Choose the Hi-Z (ON) setting if you've connected a guitar, and choose the Lo-Z (OFF) setting if you've connected any other device (p. 20).

Inverts the phase of the input signal (p. 20).

Shows the level of the signal that is input to the preamp.

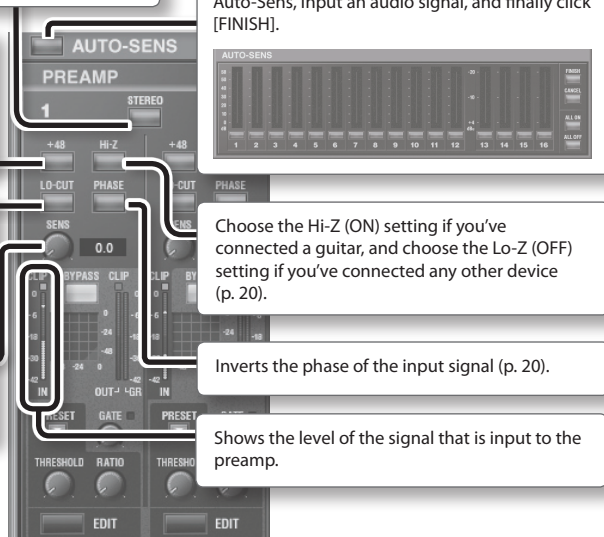

## Compressor

Disables the compressor.

Select a compressor preset.

Specifies the signal level at which the compressor begins operating. (dB)

The OUT meter shows the status of the signal that is output from the compressor.

The GR meter shows the amount of gain reduction applied by the compressor.

Mutes signals below the specified level. (dB)

Specifies the compression ratio at which the audio signal is to be compressed.

Make detailed compressor settings.

Adjusts the output level of the compressor. (dB)

Adjusts whether the compressor will start being applied abruptly when the threshold level is exceeded, or will change smoothly and gradually around the threshold level.

Specifies the time from when the input level falls below the threshold level until the compressor stops operating. (msec)

Specifies the time from when the input level exceeds the threshold until the compressor begins to operate. (msec)



## Compressor presets

You can save your favorite settings as user presets, and load them later when you need them.

<b>To save</b>	Click [PRESET], then [Store...], then the save-destination preset number (U00–U15), and enter a preset name of up to 16 characters.
<b>To load</b>	Click [PRESET], then [User Preset], then the preset number that you want to load (U00–U15).

# Using the STUDIO-CAPTURE Control Panel

## Attenuator Screen

Each of the INPUT 13–16 jacks lets you attenuate the incoming audio signal, allowing you to adjust the input level

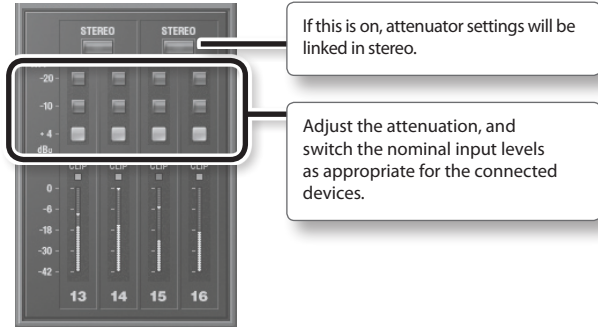

## Monitor Mixer Control Screen

If this is on, the four mixers A–D can be controlled independently. Tabs B, C, and D will appear below in addition to the MONITOR A tab.

In addition, the patch bay will switch to the settings for when the [MULTIPLE-MONITOR] button (p. 37) is pressed in the PATCHBAY dialog box.

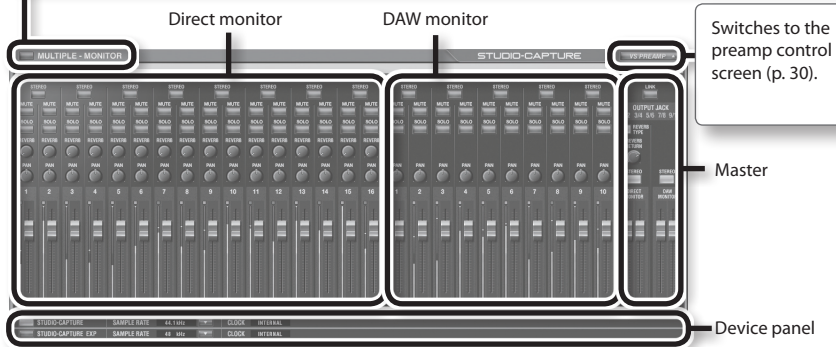

### MEMO

- With the factory settings, only monitor mixer A is shown. If you want to control the four mixers, click the [MULTIPLE-MONITOR] button.
- If the unit is operating at the 192 kHz sample rate, only monitor mixer A is available.

## Direct monitors A–D

Here you can control the monitor level and balance of the audio data being input via INPUT 1–16 jacks.

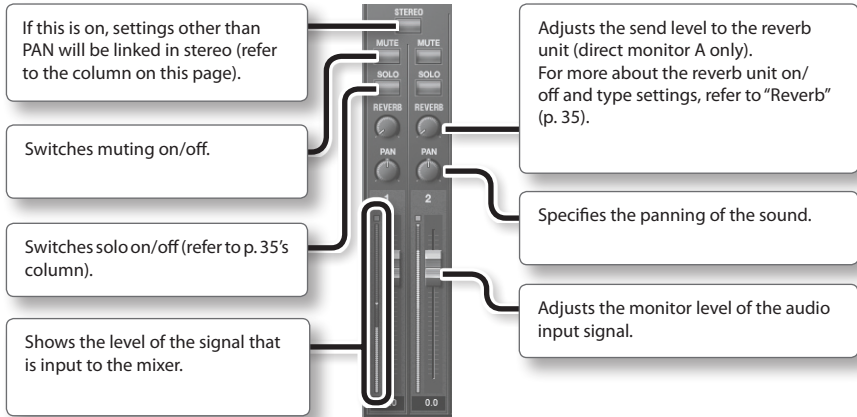

### MEMO

Direct monitor "A" can be controlled from the STUDIO-CAPTURE unit itself (p. 23).



## Changing what happens when the [STEREO] button is turned on

You can specify whether the [STEREO] button of the same channels in the preamp control screen and the monitor mixer control screen (p. 32) will be linked when you click the [STEREO] button.

In the STUDIO-CAPTURE Control Panel, click the "Device" menu, then click [Device Settings] and make this setting.

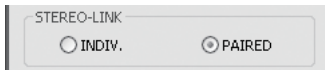

Value	Explanation
INDIV.	Stereo link can be turned on/off individually for the preamp and the monitor mixer.
PAIRED	Stereo link will turn on/off simultaneously for the preamp and the monitor mixer.

# Using the STUDIO-CAPTURE Control Panel

## DAW monitor A–D

Here you can control the balance of the five stereo channels of audio data sent from the computer, and send it to the headphones or the monitoring section.

You can control the four output mixers independently.

This diagram shows a vertical control panel for DAW monitoring. It features two columns of controls, each labeled 'STEREO'. The left column includes a 'MUTE' button, a 'SOLO' button, a 'PAN' knob, and a vertical level meter. The right column includes another 'MUTE' button, another 'SOLO' button, another 'PAN' knob, and another vertical level meter. A '2' is printed between the two level meters. Callouts provide the following information:

- MUTE buttons:** Switches mute on/off.
- SOLO buttons:** Switches solo on/off (refer to the column on p. 35).
- PAN knobs:** Specifies the panning of the sound.
- Level meters:** Shows the level of the signal that is output from the compressor. (The left meter is circled in the image).
- Right level meter:** Adjusts the monitor level of the audio signal from the computer.

## Master A–D

Here you can control the master output levels of the direct monitor and the DAW monitor.

This diagram shows a vertical control panel for the Master section. It includes a 'LINK' button, an 'OUTPUT JACK' selector (with options 1/2, 3/4, 5/6, 7/8, 9/11), a 'REVERB TYPE' selector, a 'REVERB RETURN' knob, two 'STEREO' buttons, and two vertical level meters labeled 'DIRECT MONITOR' and 'DAW MONITOR'. Callouts provide the following information:

- LINK button:** If this setting is on, the master volume of the director monitor and DAW monitor will be linked.
- OUTPUT JACK selector:** Indicates the output destination for each monitor mixer. \* Use the patch bay (p. 37) to specify the output destination.
- REVERB RETURN knob:** Adjusts the return level to the reverb unit (direct monitor A only).
- STEREO buttons:** If this is on, the master output levels of the left and right channels will be linked.
- Level meters:** Adjust the master output levels for direct monitor and DAW monitor, respectively.

A screenshot of the reverb dialog is shown in a callout box:

```

    TYPE: ECHO
    PRE DELAY [ms] : 0.0
    TIME [sec] : 1.4
    Initial Setting Close
  
```

## Reverb

You can apply reverb to the audio signal of the direct monitor in the monitor mixer A.

Setting	Value	Explanation
TYPE	OFF	No reverb will be applied.
	ECHO	Echo will be applied.
	ROOM	Reverb that simulates the reverberation of a room.
	SMALL HALL	Reverb that simulates the reverberation of a hall; produces a more spacious reverberation than ROOM.
	LARGE HALL	
	PLATE	Simulates plate reverberation (a reverb unit that uses the vibration of a metallic plate). Provides a metallic sound with a distinct upper range.
PRE-DELAY	0, 0.1, 0.2, 0.4, 0.8, 1.6, 3.2, 6.4, 10, 20, 40, 80, 160 ms	Adjusts the time from when the direct sound is output until the effect sound is output. Lengthening the pre-delay will create an effect in which multiple sounds are heard.
TIME	0.1–5.0 s	Adjusts the time over which the reverberation decays to silence.

### MEMO

- You can adjust the PRE-DELAY and TIME parameters for each TYPE.
- The reverb can also be controlled from the STUDIO-CAPTURE itself (p. 24).
- Reverb is not available when operating at a sampling rate of 192 kHz.



## Changing how the [SOLO] button works

You can specify complete muting or a specific level reduction for the channels other than the soloed channel in the monitor mixer control screen.

In the STUDIO-CAPTURE Control Panel, click the "Device" menu, then click [Device Settings] and make this setting.



Value	Explanation
OFF	The channels will be muted.
-6	The level will decrease by -6 dB.
-12	The level will decrease by -12 dB.
-18	The level will decrease by -18 dB.

# Using the STUDIO-CAPTURE Control Panel

## Device panel

Here you can view the status of the STUDIO-CAPTURE's settings.

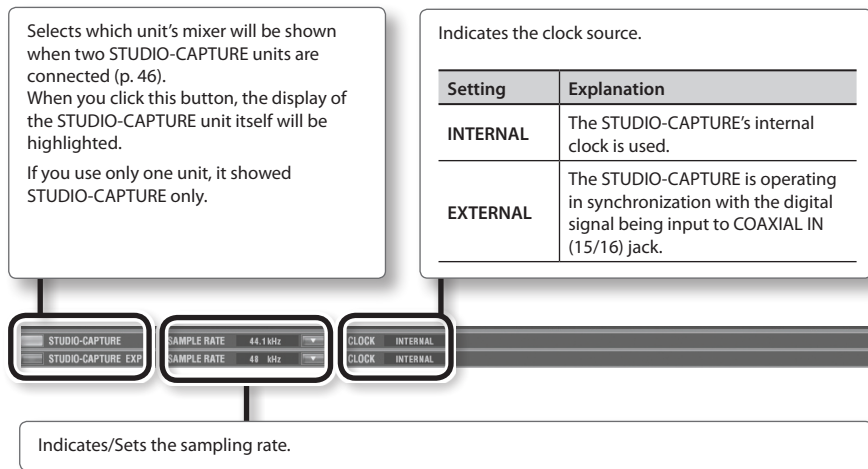

### About the sampling rate

The sampling rate setting of the STUDIO-CAPTURE automatically changes to match the rate of the audio data that is played, or the rate that your DAW software is set to when recording.

But you can also change the sampling rate of the STUDIO-CAPTURE manually. Click [▼] of the SAMPLE RATE on the device panel, then select another sampling rate. In this case, you may also need to change the sampling rate of the DAW software.

- \* The sampling rate cannot be changed during playback or recording, or when equipment is connected to the COAXIAL IN (15/16) jack.
- \* When the sampling rate is switched, a small pop noise may be heard, but this does not indicate a malfunction.



## Patch Bay

The PATCHBAY dialog box will appear when you choose [Open the Patchbay] from the “Device” menu.

As appropriate for your needs, you can freely assign the output destinations of the four monitor mixers and the output destinations of the playback channels from the computer.

\* The patch bay is not available when operating at a sampling rate of 192 kHz.

### MEMO

The patch bay can also be controlled from the STUDIO-CAPTURE itself (p. 43).

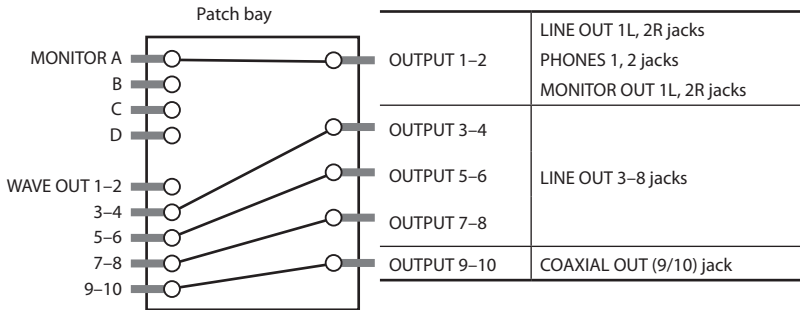

For each output jack, choose the source that you want to patch.

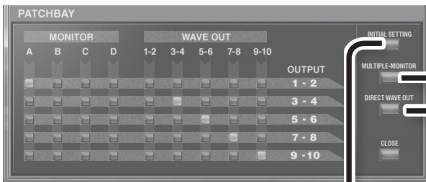

Outputs to four monitor systems.

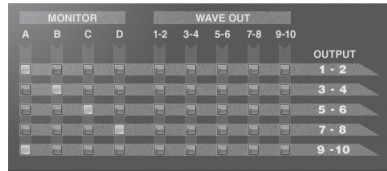

Restores the default settings.

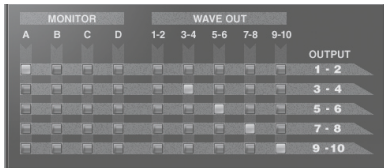

\* The patch bay will have these settings when you click the [MULTIPLE DIRECT MIXER] button (p. 32) in the monitor control screen.

The output from the computer will be output without change.

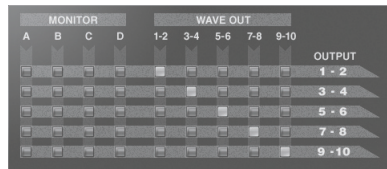

\* This setting is convenient if you're using the “soft-thru” function of your DAW software such as SONAR, instead of using the STUDIO-CAPTURE's direct monitor function.

# Saving or Loading Settings on the Computer

From the STUDIO-CAPTURE Control Panel, you can save the current settings as a file, or load previously saved settings from a file.

The following settings are saved.

- Preamp (p. 30)
- Compressor (p. 31)
- Attenuator (p. 32)
- Monitor mixer A–D (p. 32)
- Reverb (p. 35)
- Patch bay (p. 37)

\* If you're using two connected STUDIO-CAPTURE units, you can save the settings for each unit individually. To save settings for both units, select each in the device panel and its settings.

## Saving settings

---

1. From the “Device” menu, choose [Save settings].
2. Specify the file in which the settings are to be saved.

## Loading settings

---

1. From the “Device” menu, choose [Load settings].
2. Specify the file that contains the settings you want to load.

# Saving or Loading Compressor Presets on the Computer

You can save 16 user presets (numbers U00–U15) as a file, and load a set of 16 user presets from a file.



## Saving user presets as a file

---

1. In the preamp control screen (p. 30), click [PRESET], then [User Preset], then [Save User Presets...].
2. Specify a name for the file to be saved.

### Loading user presets from a file

1. In the preamp control screen (p. 30), click [PRESET], then [User Preset], then [Load User Presets...].
2. Select the file that you want to load.

\* When you load user presets from a file, all 16 of the currently stored user presets will be overwritten.

## Changing the AUTO-SENS Settings

You can choose whether AUTO-SENS (p. 30) will be ended automatically or manually. You can also specify the maximum setting for the recording level. The recording level will be set automatically according to the maximum volume that was input during the AUTO-SENS setting time.

#### MEMO

The setting can also be controlled from the STUDIO-CAPTURE itself (p. 43).

1. From the “Device” menu, select [Device settings].
2. From the items in “AUTO-SENS,” select “AUTO” or “MANUAL.”

Value	Explanation
AUTO (default)	The AUTO-SENS setting will finish automatically after there has been no input for approximately four seconds, after the [AUTO-SENS] button was pressed.
MANUAL	The AUTO-SENS setting will not finish until you press the [AUTO-SENS] button again.

3. Using “Margin,” you can change the maximum value of the recording level that is detected.

Range for Margin: 0–12

Value	Explanation
6 (default)	Headroom is set at 6 dB. This setting provides a good overall balance.
0	The maximum value for the recording level is set at 0 dBFS. Clipping will occur if audio that exceeds the recording level detected by AUTO-SENS is input.
12	Headroom is set at 12 dB. The recording level will be reduced.

## Using the STUDIO-CAPTURE Control Panel

### Directly Outputting Each Channel's Input

If you choose the command [Directly Output the Inputs] from the "Device" menu, the input signals from the INPUT 1–8 jacks will be passed directly to the output jacks.

\* The settings of mixers A–D and the patch bay will change.

This is convenient when you want to use a mixing console to adjust monitor levels without using the STUDIO-CAPTURE's internal mixer.

### Patch bay settings

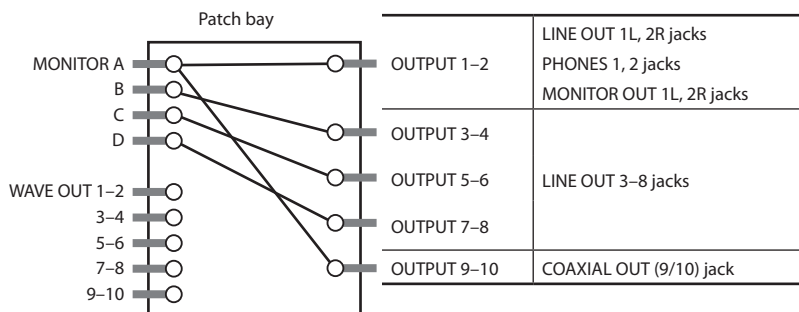

### Monitor mixer settings

Direct monitor A	INPUT 1: 0 dB, 100% L INPUT 2: 0 dB, 100% R	Other INPUT: -∞ dB
Direct monitor B	INPUT 3: 0 dB, 100% L INPUT 4: 0 dB, 100% R	Other INPUT: -∞ dB
Direct monitor C	INPUT 5: 0 dB, 100% L INPUT 6: 0 dB, 100% R	Other INPUT: -∞ dB
Direct monitor D	INPUT 7: 0 dB, 100% L INPUT 8: 0 dB, 100% R	Other INPUT: -∞ dB
Master A–D	REVERB TYPE: OFF (only master A)	
	Monitor level of the Direct monitor: 0 dB	

# Synchronizing with Other Devices

If you're using a coaxial cable to synchronize the STUDIO-CAPTURE with another device, click the "Device" menu, then click [Device Settings] and make the appropriate settings for "SYNC" and "INPUT SELECTOR (15/16)."

For details, refer to "Connecting Two STUDIO-CAPTURE Units" (p. 46) or "Synchronizing with Another Digital Device" (p. 52).

### MEMO

The setting can also be controlled from the STUDIO-CAPTURE itself (p. 43).

# Initializing the Settings

The STUDIO-CAPTURE allows you to initialize each setting independently.

### MEMO

- Settings can also be initialized from the STUDIO-CAPTURE itself (p. 44).
- To restore the factory settings, refer to "Restoring the Factory Settings (Factory Reset)" (p. 54).

1. From the "Device" menu, choose [Initialize].
2. From the items shown, choose the item that you want to initialize.

Displayed item	Content that will be initialized
ALL	Preamp, monitor mixer, reverb, and patch bay
MIC PRE	Compressor settings and preamp settings
MONITOR MIX	Monitor mixer A–D settings
REVERB	Reverb settings
PATCHBAY	Patch bay settings

A confirmation screen will appear.

3. Click [OK] to initialize, or click [Cancel] to cancel without initializing.

# Checking the Signal Flow

From the "Device" menu, choose [Show the signal flow] to view a block diagram.

## Using the STUDIO-CAPTURE Control Panel

---

### USB Driver Settings

Here's how to view or modify the USB driver settings. For details, refer to "USB Driver Settings" (p. 54).

#### Windows

From the "Driver" menu, choose [Driver Settings].

#### Mac OS X

From the "STUDIO-CAPTURE Control Panel" menu, choose [Driver Settings].

### View in Foreground

#### Windows

From the "Driver" menu, choose [Always on top].

#### Mac OS X

From the "STUDIO-CAPTURE Control Panel" menu, choose [Always on top].

# Changing the System Settings

System settings can be changed in the STUDIO-CAPTURE's SYSTEM screen.

## 1. Press the [VALUE] knob ([MENU] button).

The SYSTEM screen appears.

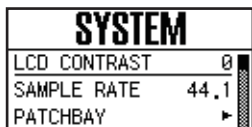

## 2. Use the [▲] [▼] cursor buttons to move the cursor to the parameter that you want to change.

For parameters shown with the “▶” symbol on the right, you can access advanced settings by pressing the cursor [▶] button.

## 3. Turn the [VALUE] knob to change the setting.

## 4. Press the [DISPLAY] button.

You'll be returned to the main screen.

Parameter	Explanation
LCD CONTRAST	Adjusts the contrast of the display. Higher values will make the display darker. Range: 0–19
SAMPLE RATE	Specifies the sampling rate of the STUDIO-CAPTURE itself. For details, refer to “Sampling Rate Setting” (p. 53).
PATCHBAY	For each output jack, select the source that you want to patch. As appropriate for your needs, you can freely assign the output destinations of the four direct mixers and the output destinations of the playback channels from the computer. For details on the settings, refer to “Patch Bay” (p. 37).
AUTO-SENS	Specifies the AUTO-SENS setting (p. 20, p. 23). For details, refer to “Changing the AUTO-SENS Settings” (p. 39).
BACKUP ALL PARAM	Stores the current settings (preamp, monitor mixer, reverb, patch bay) in the STUDIO-CAPTURE's memory.
RECALL ALL PARAM	Recalls the internally stored settings.
VS EXPAND	OFF: Choose this setting if you're using a single STUDIO-CAPTURE unit. ON: Choose this setting if you've connected two STUDIO-CAPTURE units. For details, refer to “Connecting Two STUDIO-CAPTURE Units” (p. 46).
SYNC	Choose “AUTO” if you're using a coaxial cable to synchronize with another device. For details, refer to “Synchronizing with Another Digital Device” (p. 52).
INPUT15/16	If you're using a coaxial cable to synchronize with another device and have connected equipment to the INPUT 15 and 16 jacks, choose “ANALOG.” Otherwise choose “AUTO.” For details, refer to “Connecting Two STUDIO-CAPTURE Units” (p. 46) or “Synchronizing with Another Digital Device” (p. 52).

# Changing the System Settings

---

Parameter	Explanation
<b>CLEAR MUTE/ SOLO</b>	Initializes the mute and solo settings of the channels. To initialize the settings, turn the [VALUE] knob to choose “Yes” and then press the [VALUE] knob ([MENU] button). If you decide not to clear the settings, choose “No,” and then press the [VALUE] knob ([MENU] button).
<b>DIM SOLO</b>	Specifies the level of channels that are not being soloed in the monitor mixer. For details, refer to “Changing how the [SOLO] button works” (p. 35).
<b>STEREO LINK</b>	Switches the monitor mixer’s stereo link function. For details, refer to “Changing what happens when the [STEREO] button is turned on” (p. 33).
<b>AUTO-OFF</b>	When not connected to a computer, the STUDIO-CAPTURE will automatically be switched off four hours after you stop playing or operating it (if the factory settings have been unmodified). For details, refer to “Making the Power Automatically Turn Off After a Time (Auto Off)” (p. 17).
<b>INITIALIZE</b>	Initializes the system settings. For details on the values, refer to “Initializing the Settings” (p. 41). When you select the item to be initialized, a confirmation message will appear. To initialize the settings, turn the [VALUE] knob to choose “Yes” and then press the [VALUE] knob ([MENU] button). If you decide not to clear the settings, choose “No,” and then press the [VALUE] knob ([MENU] button).  * If you want to restart the Factory Settings, refer to “Restoring the Factory Settings (Factory Reset)” (p. 54).
<b>VERSION</b>	Display the version.



# Advanced Operation

## Outputting to Four Monitor Systems

The sounds being input to INPUT 1–16 can be mixed independently by the four monitor mixers, and sent from each mixer to a different output destination.

This lets you create a separate monitor mix for each player in a band.

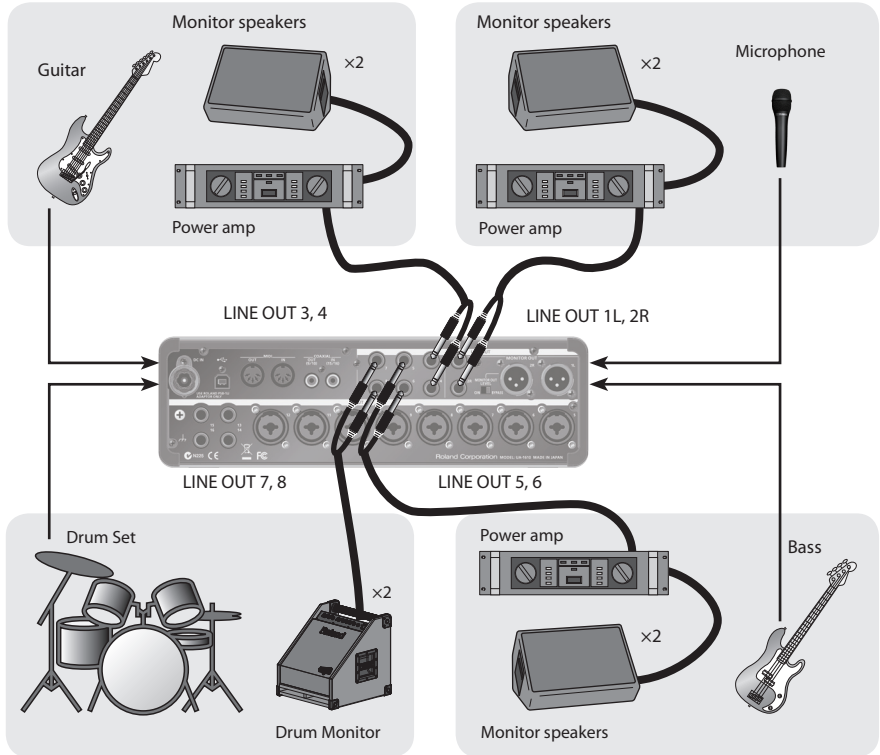

Connect your monitor speakers as shown in the illustration, and make patch bay settings as follows (p. 37, p. 43).

1. As the source for OUTPUT 1-2, choose "MONITOR A" and use it as the monitor mix for the vocalist.
2. As the source for OUTPUT 3-4, choose "MONITOR B" and use it as the monitor mix for the guitarist.
3. As the source for OUTPUT 5-6, choose "MONITOR C" and use it as the monitor mix for the bassist.
4. As the source for OUTPUT 7-8, choose "MONITOR D" and use it as the monitor mix for the drummer.

If desired, you can choose the same source for all OUTPUT.

## Connecting Two STUDIO-CAPTURE Units

If you connect two STUDIO-CAPTURE units, you'll be able to use them as a 32-in/20-out audio interface with ASIO on Windows or with Core Audio on Mac OS X.

In order to connect two STUDIO-CAPTURE units and use them, you must turn "ON" the "VS EXPAND" setting of the second unit, and set both units to digitally synchronize at the same sampling rate.

\* A maximum of two STUDIO-CAPTURE units can be synchronized.

Before you start making settings, disconnect both STUDIO-CAPTURE units from the computer and turn off their power.

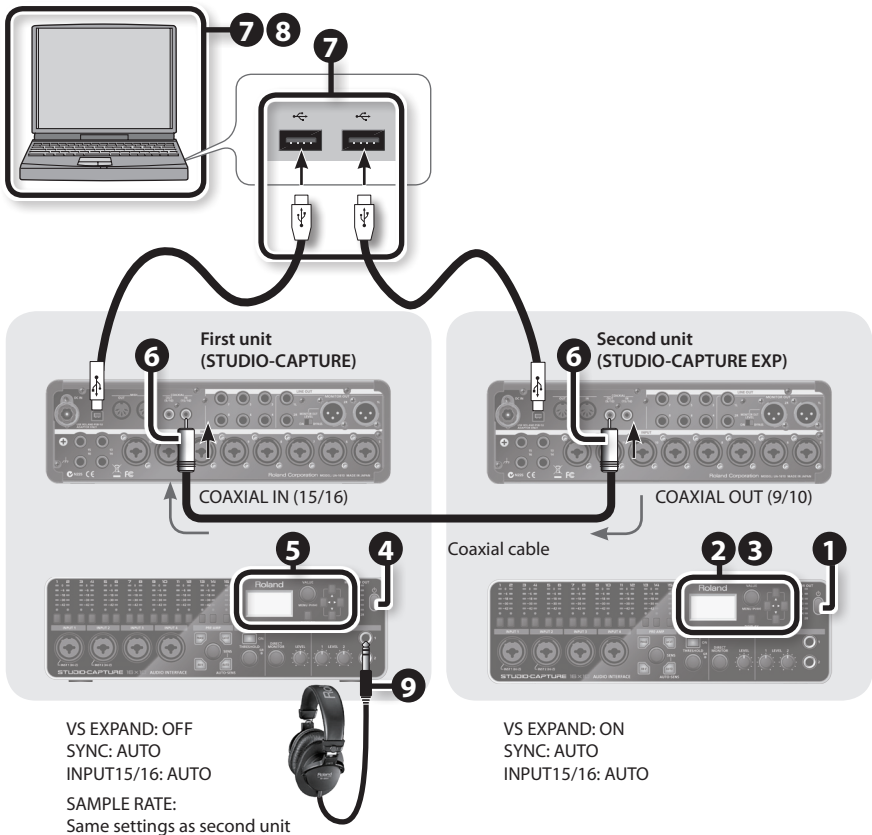

### 1. Switch on the power to the second STUDIO-CAPTURE unit.

The second STUDIO-CAPTURE unit will be the timing master.

### 2. Specify the sampling rate (p. 53).

\* When using two units, they cannot be used with the 96 and 192 kHz setting.

### 3. Make the following settings in the SYSTEM screen (p. 43).

Parameter	Value
VS EXPAND	ON
SYNC	AUTO
INPUT15/16	AUTO

If equipment is connected to the INPUT 15 and 16 jacks, choose the "ANALOG" setting.

### 4. Switch on the power to the first STUDIO-CAPTURE unit.

### 5. Set the first unit to the same sampling rate as the second unit (p. 53), and make the following settings in the SYSTEM screen (p. 43).

Parameter	Value
VS EXPAND	OFF
SYNC	AUTO
INPUT15/16	AUTO

### 6. In order to digitally synchronize the two units, use a coaxial cable to connect the second unit's COAXIAL OUT (9/10) to the first unit's COAXIAL IN (15/16).

### 7. Connect the both STUDIO-CAPTURE units to the computer.

Connect the two USB cables to USB ports that are near each other.

#### Windows 8/Windows 7/Windows Vista

The driver will be installed automatically when you connect the STUDIO-CAPTURE. Please wait.

#### Windows XP

After you've made the connection, follow steps 6-1 through 7 on p. 12 to install the driver.

# Advanced Operation

## 8. The procedure will differ depending on your system. Proceed as follows.

### Windows

If you're using Windows, the two STUDIO-CAPTURE units must be connected to the same USB controller. In the driver settings of "USB Driver Settings" (p. 54), select the VS EXPAND check box. Make sure that the "OK" indication is shown.

If this does not indicate "OK," proceed as directed below.

#### If "USB controller does not match" is shown:

Connect the second STUDIO-CAPTURE unit to a different USB port, and keep trying other USB ports until the indication is "OK" or "Sampling rate does not match."

- \* Alternatively, you can ensure that the two STUDIO-CAPTURE units are connected to the same USB controller by connecting them both to a USB 2.0 compliant hub.

#### If "Sampling rate does not match" is shown:

Disconnect both USB cables from the computer, turn off the power of the first unit, and start again from step 4. Connect each STUDIO-CAPTURE unit to the same USB port.

#### If nothing is shown in the VS EXPAND section.

Disconnect both USB cables from the computer, turn off the power of both STUDIO-CAPTURE units, and start again from step 1.

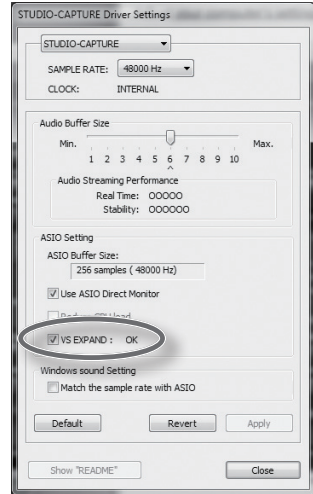

### Mac OS X

Make "Mac OS X MIDI Settings" (p. 56) for the second STUDIO-CAPTURE unit. In step 6, enter "STUDIO-CAPTURE EXP" as the [Device Name].

1. After making connections, in the Mac OS X Finder, open the [Applications] folder and then the [Utilities] folder, and then double-click [Audio MIDI Setup].
2. Click the [+] button and click "Create an Aggregate Device."
3. "Aggregate Device" will appear in the list; double-click it and edit the name. Change the device set name to "STUDIO-CAPTURES."
4. From the audio devices at the right, add a check mark to "Use" for "STUDIO-CAPTURE" and then for "STUDIO-CAPTURE EXP"
5. In the clock source field, choose "STUDIO-CAPTURE EXP"
6. If a check mark has been placed in the Resample field or the Drift Connection field, clear the check mark.

## 9. Connect your headphones to the PHONES jack of the first STUDIO-CAPTURE unit.

The number of audio ports will increase, allowing you to record and play back using 32-in/20-out.

STUDIO-CAPTURE device name	
First unit	STUDIO-CAPTURE
Second unit	STUDIO-CAPTURE EXP

## Settings for monitoring through headphones

1. Start up the STUDIO-CAPTURE Control Panel (p. 29).
2. In the lower left of the monitor mixer control screen, click the [STUDIO-CAPTURE EXP] button.



The state of the second STUDIO-CAPTURE unit will be shown.

3. From the "Device" menu, choose [Open the Patchbay].  
The PATCHBAY screen appears.
4. In the OUTPUT 9–10 field, choose "MONITOR A."
5. Close the screen.

# Advanced Operation

- 6. In the lower left of the screen, click the [STUDIO-CAPTURE] button.



The state of the first STUDIO-CAPTURE unit will be shown.

- 7. Switch to the direct mixer control screen, and check to make sure that the sliders for channels 15–16 of DIRECT MIXER A are sufficiently raised.
- 8. In order to monitor in stereo, set the channel 15 PAN to far left (100%L) and the channel 16 PAN to far right (100%R).
- 9. From the “Device” menu, choose [Open the Patchbay].  
The PATCHBAY screen will appear.
- 10. Make sure that “MONITOR A” is selected in the OUTPUT 1–2 field.

If something else is selected, change it to “MONITOR A.”

All input signals of the second STUDIO-CAPTURE unit will be output from the PHONES jack of the first unit.

## Changing the sampling rate

- 1. Change the sampling rate of the second unit (the unit that is set to STUDIO-CAPTURE EXP) as described in “Sampling Rate Setting” (p. 53).

### Input/output devices (first unit)

Input Device		Output Device	
STUDIO-CAPTURE	IN 1-2	STUDIO-CAPTURE	OUT 1-2
	IN 1-2 (2)		OUT 1-2 (2)
	IN 3-4		OUT 3-4
	IN 3-4 (4)		OUT 3-4 (4)
	IN 5-6		OUT 5-6
	IN 5-6 (6)		OUT 5-6 (6)
	IN 7-8		OUT 7-8
	IN 7-8 (8)		OUT 7-8 (8)
	IN 9-10		OUT 9-10
	IN 9-10 (10)		OUT 9-10 (10)
	IN 11-12		
	IN 11-12 (12)		
	IN 13-14		
	IN 13-14 (14)		
	IN 15-16		
	IN 15-16 (16)		
MAIN			
MAIN (R)			

Use to synchronize the first and second units.

### Input/output devices (second unit)

Input Device		Output Device	
STUDIO-CAPTURE EXP	IN 1-2	STUDIO-CAPTURE EXP	OUT 1-2
	IN 1-2 (2)		OUT 1-2 (2)
	IN 3-4		OUT 3-4
	IN 3-4 (4)		OUT 3-4 (4)
	IN 5-6		OUT 5-6
	IN 5-6 (6)		OUT 5-6 (6)
	IN 7-8		OUT 7-8
	IN 7-8 (8)		OUT 7-8 (8)
	IN 9-10		OUT 9-10
	IN 9-10 (10)		OUT 9-10 (10)
	IN 11-12		
	IN 11-12 (12)		
	IN 13-14		
	IN 13-14 (14)		
	IN 15-16		
	IN 15-16 (16)		
MAIN			
MAIN (R)			

# Synchronizing with Another Digital Device

To synchronize with another digital device, set "SYNC" to [AUTO].

You can set "SYNC" in the following locations.

- The SYSTEM screen of the STUDIO-CAPTURE unit (p. 43)
- The STUDIO-CAPTURE Control Panel "Device" menu -> [Device Settings] (p. 41)

Make the following settings if you want to digitally record the output of another digital device.

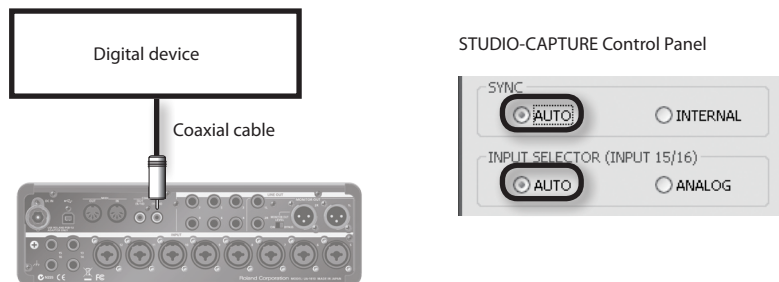

It is also possible to input analog audio signals while synchronizing with another audio device.

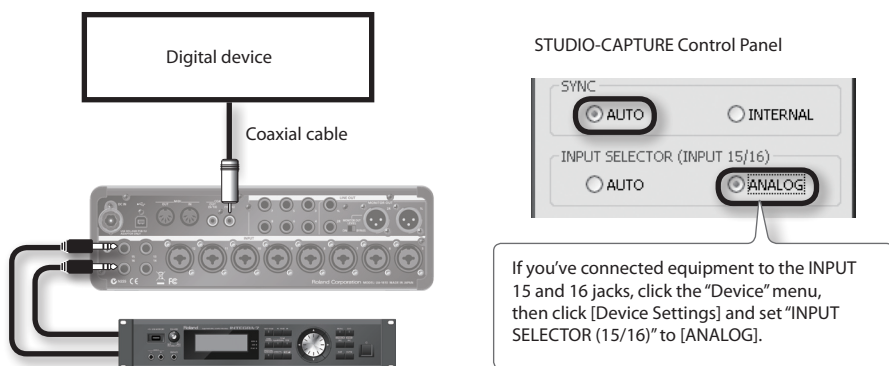

### When "SYNC" is set to [INTERNAL]

If you want the STUDIO-CAPTURE to be the master device, you can also set "SYNC" to [INTERNAL] so that synchronization will not be switched.

If "SYNC" is set to [INTERNAL], the "INPUT SELECTOR (15/16)" setting will be fixed at [ANALOG], and the COAXIAL IN (15/16) jack will be unavailable.



# Appendices

## Sampling Rate Setting

\* If software or the STUDIO-CAPTURE Control Panel that uses the STUDIO-CAPTURE is running, you must close.

1. Press the [VALUE] knob ([MENU] button) to access the SYSTEM screen.
2. Use the [▲] [▼] buttons to choose “SAMPLE RATE.”
3. Turn the [VALUE] knob to change the setting.
4. Press the [DISPLAY] button to return to the main screen.

## Limitations When Using the 192 kHz Setting

If the STUDIO-CAPTURE’s sampling rate is set to 192 kHz, its operation will be limited as follows.

- Only the INPUT 1–8 jacks and the LINE OUT 1L, 2R, 3, 4 jacks can be used. The other INPUT and LINE OUT jacks cannot be used.
- The COAXIAL OUT (9/10), IN (15/16) jacks cannot be used.
- Only monitor mixer “A” can be used. The other monitor mixers cannot be used.
- Reverb will be unavailable for monitor mixer “A.”
- Patch bay settings cannot be changed.

The LINE OUT jacks will output the audio signals of the following sources.

LINE OUT jacks	Source
LINE OUT 1L, 2R jacks	MONITOR A
LINE OUT 3, 4 jacks	WAVE OUT 3–4

- You will not be able to connect two STUDIO-CAPTURE units and synchronize them.

# Restoring the Factory Settings (Factory Reset)

After first switching off the STUDIO-CAPTURE's power, hold down the [PHASE] and [LoCUT] buttons while you press the [POWER] (Power) button to turn on the power.



The screen will indicate “Factory Reset” and the unit starts up.

# USB Driver Settings

In the driver settings dialog box you can view or change driver settings such as the buffer size.

## Windows

When using Windows 8 or Windows 7, USB driver settings cannot be changed while the monitoring function of Windows is enabled. Turn off the monitoring function (p. 69).

### 1. Exit all programs that are using the STUDIO-CAPTURE.

#### Windows 8

Exit not just Desktop applications but Windows Store Apps as well. Please wait for about 10 seconds until these applications exit completely

### 2. Click the “STUDIO-CAPTURE” icon as follows.

The “STUDIO-CAPTURE Driver settings” dialog box will appear.

#### Windows 8

Display the “Start” screen and click [STUDIO-CAPTURE].

- \* On the “Start” screen, if [STUDIO-CAPTURE] does not exist, then open the “Control Panel,” switch “View by:” to the icon view (Large icons or Small icons).

#### Windows 7/Windows Vista/Windows XP

Click the Windows [Start], then successively click [Roland], [STUDIO-CAPTURE Driver], and [STUDIO-CAPTURE].

- \* If you don't see the STUDIO-CAPTURE icon, open the “Control Panel” and switch to Icon view (Windows 7) or Classic view (Windows Vista/Windows XP).

Setting	Explanation			
<b>SAMPLE RATE</b>	<p>You can display the current sampling rate. To change the sampling rate, select a sampling rate from the menu.</p> <p>* The sampling rate cannot be changed during playback or recording, or when equipment is connected to the COAXIAL IN (15/16) jack.</p>			
<b>CLOCK</b>	<p>You can display the current clock source.</p>			
	<table border="1"> <tr> <td>INTERNAL</td> <td>The internal clock is operating.</td> </tr> <tr> <td>EXTERNAL</td> <td> <p>The clock is operating in sync with the equipment connected to the COAXIAL IN (15/16) jack.</p> <p>* The sampling rate of the input digital signal is also displayed.</p> </td> </tr> </table>	INTERNAL	The internal clock is operating.	EXTERNAL
INTERNAL	The internal clock is operating.			
EXTERNAL	<p>The clock is operating in sync with the equipment connected to the COAXIAL IN (15/16) jack.</p> <p>* The sampling rate of the input digital signal is also displayed.</p>			
<b>Audio Buffer Size</b>	<p>You can adjust the input and output audio buffer size.</p> <p>Decrease the buffer size to decrease latency. Increase the buffer size if audio drops out.</p> <p>* After adjusting the buffer size, make sure to restart all programs that are using the STUDIO-CAPTURE. If using software that has an "audio device test" function, run the test function.</p>			
<b>Use ASIO Direct Monitor</b>	<p>Check this if you are using the ASIO Direct Monitor function with an ASIO-compatible application.</p>			
<b>Reduce CPU load</b>	<p>This reduces the load on the CPU when the ASIO buffer size is small. If you experience clicks or pops with a small buffer size, selecting this check box may help.</p> <p>* If you are still unable to play/record, or if you still experience clicks and pops, clear this check box and increase the "Audio Buffer Size."</p> <p>* If you're using the STUDIO-CAPTURE in WDM/KS mode, leave this check box cleared.</p> <p>* This setting has no effect if you're using two STUDIO-CAPTURE units (VS EXPAND).</p>			
<b>VS EXPAND</b>	<p>Select this check box if you're using two STUDIO-CAPTURE units (p. 46). If this check box is selected, the status of the connection will be shown.</p> <p>* If you're using only a single STUDIO-CAPTURE unit, nothing will be shown.</p>			
<div style="background-color: #333; color: white; padding: 5px; border-radius: 5px; display: inline-block;"> <b>Windows 8/ Windows 7/ Windows Vista</b> </div> <p><b>Match the sample rate with ASIO</b></p>	<p>You can match the Windows sound sampling rate (e.g., MME, DirectSound, or WASAPI) with the ASIO sampling rate. Select this check box when using an ASIO-compatible application concurrently with an application, such as Windows Media Player, that is compatible with Windows sound.</p>			
<div style="background-color: #333; color: white; padding: 5px; border-radius: 5px; display: inline-block;"> <b>Windows XP</b> </div> <p><b>Use Multichannel WDM Audio Port</b></p>	<p>If this check box is selected, you can use all audio channels via one WDM audio port. Check this if you are using Cakewalk software, such as SONAR, with WDM/KS mode.</p> <p>* The modified setting will take effect after you turn the power of the STUDIO-CAPTURE on/off.</p> <p>* If this check box is selected, you cannot use the WDM audio ports as 2-channel (stereo) audio ports.</p>			
<b>[Show "README"]</b>	<p>This displays the online manual for the driver.</p>			

# Appendices

## Mac OS X

1. Open the “Applications” folder, and double-click the [STUDIO-CAPTURE Control Panel] icon.

The “Driver Settings” panel appears.

Setting	Explanation			
SAMPLE RATE	You can display the current sampling rate. To change the sampling rate, select a sampling rate from the menu. * The sampling rate cannot be changed during playback or recording, or when equipment is connected to the COAXIAL IN (15/16) jack.			
CLOCK	You can display the current clock source.			
	<table border="1"><tr><td>INTERNAL</td><td>The internal clock is operating.</td></tr><tr><td>EXTERNAL</td><td>The clock is operating in sync with the equipment connected to the COAXIAL IN (15/16) jack. * The sampling rate of the input digital signal is also displayed.</td></tr></table>	INTERNAL	The internal clock is operating.	EXTERNAL
INTERNAL	The internal clock is operating.			
EXTERNAL	The clock is operating in sync with the equipment connected to the COAXIAL IN (15/16) jack. * The sampling rate of the input digital signal is also displayed.			
Audio Buffer Size	You can adjust the USB driver’s input and output audio buffer size. Decrease the buffer size to decrease latency. Increase the buffer size if audio drops out. * After adjusting the buffer size, make sure to restart all programs that are using the STUDIO-CAPTURE. If using software that has an “audio device test” function, run the test function.			
Recording Margin	If audio drops out or if noise is heard even if you have adjusted the buffer size setting in the software and adjusted the “Audio Buffer Size” as explained above, increase the recording margin setting.			
Recording Timing	Adjust this setting if the timing of the recorded audio data is off. * If the audio software is running, the new setting will not be applied immediately when the [Apply] button is clicked. Quit all audio software; the new setting will be applied the next time you start the software.			

## Mac OS X MIDI Settings

Here’s how to configure the MIDI settings for Mac OS X.

1. In the Mac OS X Finder, open the [Applications] folder and then the [Utilities] folder, and then double-click [Audio MIDI Setup].
2. Click [Show MIDI Window] in the [Window] menu to display the “MIDI Studio” window.

### 3. Confirm that [STUDIO-CAPTURE] appears in the “MIDI Studio” window .

If [STUDIO-CAPTURE] does not appear or if it is grayed out, it means that the STUDIO-CAPTURE is not being detected properly.

In this case, click the [Rescan MIDI] icon. Also, try turning the STUDIO-CAPTURE off and then on again.

### 4. Click the [Add Device] icon once.

One [new external device] icon will appear.

### 5. Click the added [new external device] icon and then click the [Show Info] icon.

### 6. Enter “STUDIO-CAPTURE” in the [Device Name] field and then click the [Apply] button.



### 7. Using your mouse, drag and connect the [ ▼ ] [ ▲ ] buttons (which represent the input/ output ports of each device) of the existing [STUDIO-CAPTURE] and the newly added [STUDIO-CAPTURE] so that they are connected as shown in the figure.

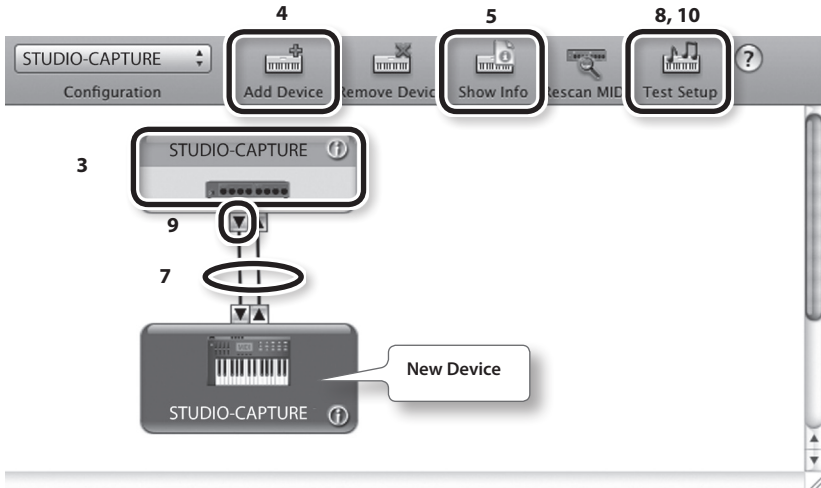

# Appendices

---

**8. Click the [Test Setup] icon.**

The [Test Setup] icon turns on (blue).

**MEMO**

If you have a sound module connected to the STUDIO-CAPTURE's MIDI OUT connector, a fairly loud sound will be heard when you perform the next step. Reduce the volume of your sound module before continuing.

**9. Click the STUDIO-CAPTURE's [ ▼ ] button.**

A confirmation sound is played from the sound module.

**10. Click the [Test Setup] icon.**

The [Test Setup] icon turns off (gray).

**11. Close the "MIDI Studio" window.**

# Troubleshooting

If you experience problems, read this first. It contains tips for solving most problems. Additional information is available in the “Win (Mac) Driver/Readme.htm” file on the STUDIO-CAPTURE Driver CD-ROM.

If this troubleshooting doesn't help you solve a problem, please refer to the support section of our website. If the problem is not resolved, refer to the contact information (refer to the last page) and contact the nearest Roland Service Center or an authorized Roland distributor.

**Roland support website:** <http://www.roland.com/support/>

## USB Driver Installation

Problem	Items to Check	Action
The installer does not start	Are you attempting to install from a networked DVD-ROM drive?	Put the CD-ROM to DVD-ROM drive connected to your computer, and install.
The USB driver does not install	Are you logged on with a user account that does not have administrator privileges?	Log on to the computer with a user account that has administrator privileges. For details, consult the administrator for your computer system.
	<b>Windows XP</b> Is the “Driver Signing Options” setting set to [Block]?	Change the “Driver Signing Options” setting. Refer to the “Win (Mac) Driver/Readme.htm” file on the STUDIO-CAPTURE Driver CD-ROM.
	Are other programs or resident programs (such as antivirus programs) running?	Be sure to exit all other programs before installation.
<b>Windows</b> A warning or error appears during installation	In the “Device Manager,” do you see “Other device,” “Unknown device,” or a device for which “?”, “!,” or “x” is displayed?	Reinstall the USB driver (p. 11).
The installer does not exit	Is your computer running on battery power?	Connect the power cord to the computer.
	Could you have connected the unit to a USB port that supports USB 3.0?	The STUDIO-CAPTURE cannot be used with a USB port that is incompatible with USB 2.0. For details on the type and compatibility of your computer's USB ports, refer to the manual that came with your computer or contact your computer's manufacturer.

# Appendices

Problem	Items to Check	Action
<p><b>Windows XP</b></p> <p>The “Found New Hardware Wizard” appears again after the USB driver is installed</p>	<p>Did you connect the STUDIO-CAPTURE to a different USB port of the computer than the one you used when installing the driver?</p>	<p>If you change the USB port to which the STUDIO-CAPTURE is connected, the “Found New Hardware Wizard” may appear again even if the USB driver has already been installed on the computer.</p> <p>Follow step 6-1 of the USB driver installation procedure (p. 12) and install the USB driver.</p>
<p><b>Windows 8/ Windows 7/ Windows Vista</b></p> <p>A numeral such as “2-” appears at beginning of the device name</p>	<p>Did you connect the STUDIO-CAPTURE to a different USB port of the computer than the one you used when installing the driver?</p>	<p>If you connect the STUDIO-CAPTURE to a different USB port of the computer than the one you used when installing the USB driver, a numeral may appear with the device name.</p> <p>To have the device name appear without the numeral, connect the STUDIO-CAPTURE to the same USB port used during installation, or reinstall the USB driver (p. 11).</p>

## Using the STUDIO-CAPTURE

Problem	Items to Check	Action
<p>Cannot select or use the STUDIO-CAPTURE device</p>	<p>Is the STUDIO-CAPTURE's display off?</p>	<p>Make sure that the STUDIO-CAPTURE is connected to the computer correctly.</p> <p>If that does not resolve the issue, reinstall the USB driver (p. 11).</p>
	<p>Could you have connected the unit to a USB port that supports USB 3.0?</p>	<p>The STUDIO-CAPTURE cannot be used with a USB port that is incompatible with USB 2.0. For details on the type and compatibility of your computer's USB ports, refer to the manual that came with your computer or contact your computer's manufacturer.</p>
	<p>Is the STUDIO-CAPTURE's device name displayed?</p>	<p>Exit all programs that are using the STUDIO-CAPTURE, turn it off, and then turn it on again.</p>
	<p>Is another program using the STUDIO-CAPTURE?</p>	<p>If that does not resolve the issue, reinstall the USB driver (p. 11).</p>
	<p>Did the computer enter standby (suspend) mode, hibernate mode, or sleep mode while the STUDIO-CAPTURE was connected?</p>	<p>Exit all programs that are using the STUDIO-CAPTURE, turn it off, and then turn it on again.</p>
	<p>Did you disconnect and reconnect the USB cable while using the STUDIO-CAPTURE?</p>	<p>If that does not resolve the issue, restart the computer.</p>



Problem	Items to Check	Action
Cannot select or use the STUDIO-CAPTURE device	Was the STUDIO-CAPTURE connected to the computer while the computer was starting up?	Connect the STUDIO-CAPTURE after the computer has started up. With some computers, the STUDIO-CAPTURE cannot be used if it is connected to the computer while the computer is starting up.
	<p><b>Windows 8/Windows 7/Windows Vista</b></p> Are you using the Music (Windows 8) or Media Player included with Windows?	Use different software. MIDI devices cannot be selected in Media Player.
	<p><b>Mac OS X</b></p> Have you configured "Audio MIDI Setup"?	Configure Audio MIDI Setup (p. 56).
	<p><b>Windows XP</b></p> Could you be using a multichannel WDM audio port?	If you want to select INPUT 3–16/OUTPUT 3–10 jacks as input/output destinations, disable the multichannel WDM audio port (p. 55).
	Could the STUDIO-CAPTURE's "VS EXPAND" setting be "ON"?	Turn the "VS EXPAND" setting "OFF," and turn the STUDIO-CAPTURE's power off, then on again (p. 43).
No sound is heard from the computer's speakers	This is not a malfunction.	When using the STUDIO-CAPTURE, no sound is heard from the computer's speakers. Connect headphones or an audio playback system (external monitors) to the STUDIO-CAPTURE.
The sound played by the computer is inaudible or too quiet	Can you hear sound by connecting headphones?	If you can hear sound through headphones connected to the PHONES 1, 2 jacks, check that you have correctly connected your audio playback system (external monitors), and adjust the volume of our equipment. If the sound in your headphones is inaudible or too soft, check the other troubleshooting items.
	Is the [MONITOR OUT LEVEL] knob of the STUDIO-CAPTURE turned down?	Use the STUDIO-CAPTURE's [MONITOR OUT LEVEL] knob to adjust the volume.
	In the STUDIO-CAPTURE Control Panel's monitor mixer control screen, could MUTE be turned on?	In the STUDIO-CAPTURE Control Panel (p. 34), check whether Mute might be turned on.
	Is the volume of the DAW monitor set appropriately?	Use the STUDIO-CAPTURE Control Panel (p. 34) to view and adjust the volume of the DAW monitor.

# Appendices

Problem	Items to Check	Action
The sound played by the computer is inaudible or too quiet	Is the patch bay set correctly?	Check the patch bay settings in STUDIO-CAPTURE Control Panel (p. 37).
	Are there channels that are set to mute or solo?	In the STUDIO-CAPTURE Control Panel, check the MUTE and SOLO settings (p. 33, p. 34).
	Is the computer's (OS) volume setting turned down?	Adjust the computer's volume setting (p.68).
	<b>Windows 8/Windows 7</b> Are you using voice communication software?	Disable automatic volume adjustment (p. 69).
	Did you adjust the USB driver's audio buffer size?	Increase the audio buffer size (p. 54).
	<b>Windows</b> Is the "Reduce CPU load" check box selected?	Clear the "Reduce CPU load" check box (p. 55).
My guitar is too quiet	Are you using the correct jack?	Connect your guitar to the INPUT 1 or INPUT 2 jacks (p. 8).
	Is the "Hi-Z" set to Off?	Set the "Hi-Z" to On (p. 20).
	Is the input level too low?	Use the [SENS] knob to adjust the input level (p. 20).
My microphone is too quiet	Are you using the correct jack?	Connect your microphone with an XLR connector to the XLR connector (INPUT 1–2 jacks) (p. 8). The sound level will be very low if you use a microphone with a phone plug.
	Is the input level too low?	Use the [SENS] knob to adjust the input level (p. 20).
	Does the sensitivity of the microphone match the input level of the STUDIO-CAPTURE?	The STUDIO-CAPTURE's microphone input level is -60 dBu for the XLR connector, and -54 dBu for the TRS phone type jack. If the sensitivity of the microphone is low, the sound will be quiet
	Is the direct monitor volume appropriate?	In the STUDIO-CAPTURE Control Panel, check and adjust the direct monitor volume (p. 33).
The volume level of the instrument connected to INPUT 1–16 jacks is too low.	Could you be using a connection cable that contains a resistor?	Use a connection cable that does not contain a resistor.

Problem	Items to Check	Action
When a signal is input via a single INPUT jack, only one channel is recorded	<p>Is the DAW software configured to record in stereo?</p> <p>If so, the signal input via the odd numbered jack is recorded on the left channel, and the signal input via the even numbered jack is recorded on the right channel.</p>	Change the DAW software's settings so that it records in monaural.
A device connected to one of the input jacks is distorting	Could the input level meter's peak indicator (0; red LED) be blinking?	Turn the [SENS] knob toward the left to reduce the input level (p. 20).
	Is the volume of the direct monitor set appropriately?	Use the STUDIO-CAPTURE Control Panel to view and adjust the volume of the direct monitor (p. 33).
Sound is interrupted during playback or recording	Are multiple programs running?	Exit programs that are not in use.
	Did you adjust the software's audio buffer size?	If the software allows you to adjust the audio buffer size, change the buffer size. Refer to the documentation for your software.
	Did you adjust the USB driver's audio buffer size?	Increase the USB driver's audio buffer size (p. 54).
	<div style="border: 1px solid black; border-radius: 10px; padding: 2px; display: inline-block; margin-bottom: 5px;"><b>Mac OS X</b></div> <p>Have you adjusted the "Recording Margin" setting?</p>	If audio drops out or if noise is heard even if you have adjusted the audio buffer size, increase the "Recording Margin" setting (p. 56).
	<div style="border: 1px solid black; border-radius: 10px; padding: 2px; display: inline-block; margin-bottom: 5px;"><b>Windows</b></div> <p>Is the system software up to date?</p>	Run Windows Update or Microsoft Update and make sure the system software is up to date.
	<div style="border: 1px solid black; border-radius: 10px; padding: 2px; display: inline-block; margin-bottom: 5px;"><b>Mac OS X</b></div> <p>Have you updated the software?</p>	Run Software Update and make sure the system software is up to date.
	Are the drivers for the computer's internal chipset and graphics card up to date?	Update to the latest drivers.
	Are the drivers for the computer's LAN hardware (wired and wireless) up to date?	Install the latest LAN hardware drivers. If the problem is not resolved, disable the LAN.

# Appendices

Problem	Items to Check	Action
Sound is interrupted during playback or recording	<p><b>Windows</b></p> <p>Is the power management setting in Windows set to economy mode?</p>	Refer to the "Win (Mac) Driver/Readme.htm" file on the STUDIO-CAPTURE Driver CD-ROM.
	<p><b>Windows</b></p> <p>Have you set the system's "Performance" setting?</p>	
	<p>Is the STUDIO-CAPTURE connected to a USB hub?</p>	Connect the STUDIO-CAPTURE directly to one of the computer's USB ports.
	<p>Are you using the included USB cable?</p>	You must use the included USB cable. Some commercially available USB cables do not meet the requirements of the USB standard, and this may prevent the STUDIO-CAPTURE from operating correctly.
	<p><b>Windows 8/Windows 7</b></p> <p>Is the monitoring function of Windows turned on?</p>	Turn off the monitoring function (p. 69).
	<p>Did you try to play back or record immediately after the computer started up or after waking up from sleep mode?</p>	Wait and try playing back or recording later.
	<p><b>Windows</b></p> <p>Is the "Reduce CPU load" check box selected?</p>	Clear the "Reduce CPU load" check box (p. 55).
Noise or distortion occurs elsewhere than in the playback from my computer	<p>Is a guitar connected?</p>	Move as far away from the computer as possible. If the noise decreases when you lower your guitar's volume, it may be that your guitar's pickups are being affected by noise from your computer or display.
	<p>Could you have left an unused microphone or guitar connected?</p>	Disconnect the unused microphone or guitar, and turn the [SENS] knob fully to the left in order to lower the input level.
	<p>Have you connected the ground terminal?</p>	You may be able to solve the problem by grounding a metal component of your computer or the ground pin of our computer's AC adaptor (p. 76). Also check whether there might be a device nearby that is emitting a strong electromagnetic field, such as a television or microwave oven.
Recordings are too loud or too quiet	<p>Is the XLR plug connected to the microphone?</p>	When you connect a microphone, please connect to the XLR plug (p. 8).

Problem	Items to Check	Action
Recordings are too loud or too quiet	Is the input level appropriate?	Use the [SENS] knob to adjust the input level of the STUDIO-CAPTURE (p. 20, p. 23). If your software has an input level adjustment, check the input level setting.
	Does the sensitivity of the microphone match the input level of the STUDIO-CAPTURE?	The STUDIO-CAPTURE's microphone input level is -60 dBu for the XLR connector, and -54 dBu for the TRS phone type jack. If the sensitivity of the microphone is low, the sound will be soft.
Cannot play back or record	Are the software's input device and output device configured?	Select the STUDIO-CAPTURE as the input and output device (p. 25).
	Is the STUDIO-CAPTURE's display off?	Make sure that the STUDIO-CAPTURE is connected to the computer correctly. If that does not resolve the issue, reinstall the USB driver (p. 11).
	Is the computer's volume setting turned down?	Adjust the computer's volume setting (p. 68).
	<b>Windows 8/Windows 7</b> Are you using voice communication software?	Disable automatic volume adjustment (p. 69).
	Did you adjust the USB driver's audio buffer size?	Increase the audio buffer size (p. 54).
	<b>Windows</b> Is the "Reduce CPU load" check box selected?	Clear the "Reduce CPU load" check box (p. 55).
Cannot play back or record 24-bit audio data	Does your software support 24-bit audio data?	Check whether your software supports playback and recording of 24-bit audio data.
	Is the software set correctly?	Make sure that your software is set to play and record 24-bit audio data.
Cannot record via a digital connection / Something is wrong with the recorded sound	Is "INPUT SELECTOR (15/16)" set to [AUTO]?	If you want audio from a CD or other source to be input digitally into your computer, set "INPUT SELECTOR (15/16)" to [AUTO] (p. 52).
	Does the STUDIO-CAPTURE's sample rate setting match the sample rate setting of the digital device from which you're trying to record?	Set the STUDIO-CAPTURE to the same sample rate as the device from which you're recording (p. 53).
	Is the STUDIO-CAPTURE's system setting "INPUT15/16" set correctly?	In the SYSTEM screen, make sure that the "INPUT15/16" setting is "AUTO." Also make sure that your digital device is correctly connected to the COAXIAL IN (15/16) jack, and that a digital signal is being input.

## Appendices

Problem	Items to Check	Action
Cannot change the sampling rate in USB Driver Settings or software.	Are you playing or recording audio data?	Change the sampling rate within the software currently being used, or exit the software and then change the sampling rate in the Driver Settings dialog box.
	Is there another program using the STUDIO-CAPTURE?	Exit the program that is using the STUDIO-CAPTURE.
	Is equipment connected to the COAXIAL IN (15/16) jack?	Set the sampling rate setting of the software to match the sampling rate of the equipment connected to the COAXIAL IN (15/16) jack.
	<b>Windows</b> Is the Sound Control Panel open?	Close the Sound Control Panel.
	<b>Windows 8/Windows 7</b> Is the monitoring function of Windows enabled?	Disable the monitoring function (p. 69).

## Problems When Two Units Are Connected

Problem	Items to Check	Action
ASIO or CoreAudio does not show the audio ports of the two units	Could a USB device other than the STUDIO-CAPTURE units, a mouse, and a keyboard be connected?	Make sure that all USB devices other than the STUDIO-CAPTURE units, mouse, and keyboard are disconnected from your computer.
	Are the STUDIO-CAPTURE's "VS EXPAND" settings correct?	Set the first STUDIO-CAPTURE unit's "VS EXPAND" to "OFF," and the second unit to "ON" (p. 47).
	<b>Mac OS X</b> Have you selected "STUDIO-CAPTURE" as the audio setting in your DAW software?	Check step 8 of "Connecting Two STUDIO-CAPTURE Units" (p. 48).

Problem	Items to Check	Action
<b>Cannot hear the monitor sound of the second unit</b>	Could your headphones or monitor speakers be connected to the first STUDIO-CAPTURE unit?	Connect your headphones and monitor speakers to the first STUDIO-CAPTURE unit.
	Could you have connected a coaxial cable from the second unit's COAXIAL OUT (9/10) jack to the first unit's COAXIAL IN (15/16) jack?	Connect the coaxial cable correctly
	In the second unit's "PATCH BAY," is "MONITOR A" selected for "OUTPUT 9-10"?	Check the "Patch bay" of the second unit (p. 49).
	Is the second unit's MONITOR A "MASTER VOLUME" raised?	Click the "MONITOR A" tab of the second unit and check the setting (p. 49).
	In the first unit's "PATCH BAY," is "MONITOR A" selected for "OUTPUT 1-2"?	Check the "Patch bay" of the first unit (p. 49).
	In the first unit's "DIRECT MONITOR A" is the 15-16 slider raised? Is "PAN" set to 100%L for channel 15 and 100%R for channel 16?	Check the procedure in "Settings for monitoring through headphones" (p. 49).
<b>Interruptions, dropouts, or other problems occur during the performance</b>	Have you used a coaxial cable to connect the second unit's COAXIAL OUT (9/10) to the first unit's COAXIAL IN (15/16) jack?	Dropouts and other problems will occur if the two units are not digitally synchronized. Check the connections as described in "Connection Two STUDIO-CAPTURE Unit" (p. 46).
	Did you try adjusting the USB driver's "Audio Buffer Size" jack?	Try increasing the buffer size as described in "USB Driver Settings" (p. 54).
	Could a USB device other than the STUDIO-CAPTURE, a mouse, and a keyboard be connected?	Disconnect all USB devices other than the STUDIO-CAPTURE, a mouse, and a keyboard from your computer.
<b>Cannot change the sampling rate</b>	Have you set the second unit's sampling rate?	Change the sampling rate using the procedure described in "Sampling Rate Setting" (p. 53).
<b>The message "MISMATCH CLOCK" appears in the STUDIO-CAPTURE's display</b>	Are both units set to the same sample rate?	Open the STUDIO-CAPTURE Control Panel and check the device panel (p. 36).

# Changing Computer Settings to Avoid Problems

This section explains how to solve problems discussed in “Using the STUDIO-CAPTURE” (p. 60).

For details about configuring your operating system’s settings or deleting the USB driver, refer to the “Win (Mac) Driver/Readme.htm” file on the STUDIO-CAPTURE Driver CD-ROM.

## Setting the System Volume

If the playback volume is too loud or too low, try adjusting the system volume.

### Windows 8/Windows 7

1. Open the “Control Panel” and set the display mode to “Category.”
2. Click the [Hardware and Sound] icon, and then click the [Adjust system volume] icon.
3. After the volume mixer appears, select the STUDIO-CAPTURE’s [1–2 (STUDIO-CAPTURE)] from the “Device” menu and adjust the volume.

### Windows Vista

1. Open the “Control Panel” and click the [Hardware and Sound] icon.  
If you have selected Classic view, click [Control Panel Home] to exit Classic view.
2. Click the [Adjust system volume] icon in “Sound.”
3. After the volume mixer appears, select [1–2 (STUDIO-CAPTURE)] from the “Device” menu and adjust the volume.  
If [Mute] is set to “On,” click [Mute] to set it to “Off.”

### Windows XP

1. Open the “Control Panel,” click the [Sounds, Speech, and Audio Devices] icon, and then click the [Sounds and Audio Devices] icon.  
If you have selected Classic view, double-click the [Sounds and Audio Devices] icon.
2. Click the [Audio] tab.
3. In the “Sound playback” area, make sure that [1–2 (STUDIO-CAPTURE)] is selected as the “Default device,” and click the [Volume] button.
4. When the volume control appears, adjust the “Wave” volume.  
If the mute check box is selected, clear the check box.



### Mac OS X

1. Open “System Preferences” and click the [Sound] icon.
2. Click the [Output] tab.
3. In the “Select a device for sound output” area, make sure that [STUDIO-CAPTURE] is selected and use the “Output volume” slider to adjust the volume.  
If the mute check box is selected, clear the check box.

## Voice Communication Software Settings Windows 8/Windows 7

If you are using voice communication software, the volume of the audio device may be adjusted automatically to suit the characteristics of the conversation.

Use the following procedure to disable automatic volume adjustment.

1. Open the “Control Panel,” click the [Hardware and Sound] icon, and then click the [Sound] icon.  
If you have selected Icon view, click the [Sound].
2. In the [Communications] tab, set “When Windows detects communications activity” to [Do nothing].
3. Click the [OK] button to close the “Sound” window.

## Monitoring Function Settings Windows 8/Windows 7

If the monitoring function of Windows is enabled, the input sound may be doubled (each sound is repeated) or feedback may be heard.

Use the following procedure to disable the monitoring function of Windows.

1. Open the “Control Panel,” click the [Hardware and Sound] icon, and then click the [Sound] icon.  
If you have selected Icon view, click the [Sound] icon.
2. In the “Recording” area, click the STUDIO-CAPTURE’s [1–2 (STUDIO-CAPTURE)], and then click the [Properties] button.
3. Open the “Listen” tab and clear the [Listen to this device] check box.
4. Click the [OK] button to close the “Properties” window.
5. Click the [OK] button to close the “Sound” window.

# Main Specifications

## Roland STUDIO-CAPTURE (UA-1610): USB 2.0 Audio Interface

Number of Audio Record/ Playback Channels	Sampling Rate: 192 kHz, 96 kHz, 48 kHz, 44.1 kHz
	Record: 16 channels Playback: 10 channels
Signal Processing	PC interface: 24 bits
	AD/DA Conversion: 24 bits
Sampling Rate	AD/DA Conversion: 192 kHz, 96 kHz, 48 kHz, 44.1 kHz
	DIGITAL (IN/OUT): 96 kHz, 48 kHz, 44.1 kHz
Nominal Input Level (variable)	Input 1–12 jacks (XLR type): -60– -2 dBu
	Input 1–12 jacks (1/4-inch TRS phone type): -54– +4 dBu
	Input 13–16 jacks (1/4-inch TRS phone type): -20, -10, +4 dBu
Nominal Output Level	OUTPUT 1–8 jacks: +4 dBu (balanced)
Headroom	18 dB
Input Impedance	Input 1–12 jacks (XLR type): 8.2 k ohms (balanced)
	Input 1–12 jacks (1/4-inch TRS phone type): 18 k ohms (balanced)
	Input 13–16 jacks (1/4-inch TRS phone type): 38 k ohms (balanced)
Output Impedance	OUTPUT 1–2 jacks (XLR type): 600 ohms (balanced)
	OUTPUT 1–8 jacks (1/4-inch TRS phone type): 2k ohms (balanced)
	PHONES: 47 ohms
Frequency Response	192.0 kHz: 20 Hz–60 kHz (+0/-2 dB), 20 Hz–90 kHz (+0/-8 dB)
	96.0 kHz: 20 Hz–40 kHz (+0/-2 dB)
	48.0 kHz: 20 Hz–22 kHz (+0/-2 dB)
	44.1 kHz: 20 Hz–20 kHz (+0/-2 dB)
Residual Noise Level	INPUT 1–2 -> OUTPUT 1–2: -90 dBu typ. (SENS = min., Input terminated with 600 ohms, INPUT MONITOR = OFF, IHF-A) * Input channel fader = Unity
Dynamic Range	AD block INPUT 1–2: 105 dB typ. (SENS = min.) DA block OUTPUT 1–2: 114 dB typ.
Display	Graphic LCD 128 x 64 dots

## Main Specifications

<b>Connectors</b>	INPUT 1–12 jacks *1: XLR type (balanced, phantom power *2: DC +48 V (unloaded maximum), 10 mA (maximum load)) *1 INPUT 1–2 jacks support high impedance *2 Provided on all XLR-type input jacks. Current value is per channel. Total must not exceed 50 mA.
	INPUT 1–16 jacks: 1/4-inch TRS phone type (balanced)
	PHONES jack: Stereo 1/4-inch phone type
	OUTPUT 1–8 jacks: 1/4-inch TRS phone type (balanced)
	COAXIAL IN jack: RCA phono type (conforms to IEC60958)
	COAXIAL OUT jack: RCA phono type (conforms to IEC60958)
	MIDI (IN, OUT) connectors
	USB port: USB Type B DC IN jack
<b>Interface</b>	Hi-Speed USB
<b>Power Supply</b>	AC adaptor
<b>Current Draw</b>	1.6 A
<b>Dimensions</b>	284 (W) x 162 (D) x 89 (H) mm 11-3/16 (W) x 6-7/16 (D) x 3-9/16 (H) inches
<b>Weight (excluding AC adaptor and rack mount angles)</b>	1.9 kg 4 lb 4 oz
<b>Accessories</b>	Owner's Manual Block Diagram leaflet AC adaptor STUDIO-CAPTURE Driver CD-ROM Rack mount angle x 2 USB cable License agreement

\* 0 dBu=0.775 Vrms

\* In the interest of product improvement, the specifications and/or appearance of this unit are subject to change without prior notice.



# USING THE UNIT SAFELY

## INSTRUCTIONS FOR THE PREVENTION OF FIRE, ELECTRIC SHOCK, OR INJURY TO PERSONS

### About ⚠ WARNING and ⚠ CAUTION Notices

<b>⚠ WARNING</b>	Used for instructions intended to alert the user to the risk of death or severe injury should the unit be used improperly.
<b>⚠ CAUTION</b>	Used for instructions intended to alert the user to the risk of injury or material damage should the unit be used improperly.  * Material damage refers to damage or other adverse effects caused with respect to the home and all its furnishings, as well to domestic animals or pets.

### About the Symbols

	The ⚠ symbol alerts the user to important instructions or warnings. The specific meaning of the symbol is determined by the design contained within the triangle. In the case of the symbol at left, it is used for general cautions, warnings, or alerts to danger.
	The ⚡ symbol alerts the user to items that must never be carried out (are forbidden). The specific thing that must not be done is indicated by the design contained within the circle. In the case of the symbol at left, it means that the unit must never be disassembled.
	The ⏻ symbol alerts the user to things that must be carried out. The specific thing that must be done is indicated by the design contained within the circle. In the case of the symbol at left, it means that the power-cord plug must be unplugged from the outlet.

## ALWAYS OBSERVE THE FOLLOWING

### WARNING

#### To completely turn off power to the unit, pull out the plug from the outlet

Even with the power switch turned off, this unit is not completely separated from its main source of power. When the power needs to be completely turned off, turn off the power switch on the unit, then pull out the plug from the outlet. For this reason, the outlet into which you choose to connect the power cord's plug should be one that is within easy reach and readily accessible.



#### Concerning the AUTO-OFF function

The power to this unit will be turned off automatically after a predetermined amount of time has passed since it was last used for playing music, or its buttons or controls were operated (AUTO-OFF function). If you do not want the power to be turned off automatically, disengage the AUTO-OFF function (p. 17).



#### Do not disassemble or modify by yourself

Do not open (or modify in any way) the unit or its AC adaptor.



### WARNING

#### Do not repair or replace parts by yourself

Do not attempt to repair the unit, or replace parts within it (except when this manual provides specific instructions directing you to do so). Refer all servicing to your retailer, the nearest Roland Service Center, or an authorized Roland distributor, as listed on the "Information" page.



#### Do not use or store in the following types of locations

- Subject to temperature extremes (e.g., direct sunlight in an enclosed vehicle, near a heating duct, on top of heat-generating equipment); or are
- Damp (e.g., baths, washrooms, on wet floors); or are
- Exposed to steam or smoke; or are
- Subject to salt exposure; or are
- Humid; or are
- Exposed to rain; or are
- Dusty or sandy; or are
- Subject to high levels of vibration and shakiness.



#### Do not place in an unstable location

Make sure you always have the unit placed so it is level and sure to remain stable. Never place it on stands that could wobble, or on inclined surfaces.



## WARNING

### Use only the supplied AC adaptor and the correct voltage

Be sure to use only the AC adaptor supplied with the unit. Also, make sure the line voltage at the installation matches the input voltage specified on the AC adaptor's body. Other AC adaptors may use a different polarity, or be designed for a different voltage, so their use could result in damage, malfunction, or electric shock.



### Use only the supplied power cord

Use only the attached power-supply cord. Also, the supplied power cord must not be used with any other device.



### Do not bend the power cord or place heavy objects on it

Do not excessively twist or bend the power cord, nor place heavy objects on it. Doing so can damage the cord, producing severed elements and short circuits. Damaged cords are fire and shock hazards!



### Avoid extended use at high volume

This unit, either alone or in combination with an amplifier and headphones or speakers, may be capable of producing sound levels that could cause permanent hearing loss. Do not operate for a long period of time at a high volume level, or at a level that is uncomfortable. If you experience any hearing loss or ringing in the ears, you should immediately stop using the unit, and consult an audiologist.



### Don't allow foreign objects or liquids to enter unit; never place containers with liquid on unit

Do not place containers containing liquid (e.g., flower vases) on this product. Never allow foreign objects (e.g., flammable objects, coins, wires) or liquids (e.g., water or juice) to enter this product. Doing so may cause short circuits, faulty operation, or other malfunctions.



## WARNING

### Turn off the unit if an abnormality or malfunction occurs

Immediately turn the unit off, remove the AC adaptor from the outlet, and request servicing by your retailer, the nearest Roland Service Center, or an authorized Roland distributor, as listed on the "Information" page when:



- The AC adaptor, the power-supply cord, or the plug has been damaged; or
- If smoke or unusual odor occurs; or
- Objects have fallen into, or liquid has been spilled onto the unit; or
- The unit has been exposed to rain (or otherwise has become wet); or
- The unit does not appear to operate normally or exhibits a marked change in performance.

### Adults must provide supervision in places where children are present

When using the unit in locations where children are present, be careful so no mishandling of the unit can take place. An adult should always be on hand to provide supervision and guidance.



### Do not drop or subject to strong impact

Protect the unit from strong impact.

(Do not drop it!)



### Do not share an outlet with an unreasonable number of other devices

Do not force the unit's power-supply cord to share an outlet with an unreasonable number of other devices. Be especially careful when using extension cords—the total power used by all devices you have connected to the extension cord's outlet must never exceed the power rating (watts/amperes) for the extension cord. Excessive loads can cause the insulation on the cord to heat up and eventually melt through.



### Do not use overseas

Before using the unit in overseas, consult with your retailer, the nearest Roland Service Center, or an authorized Roland distributor, as listed on the "Information" page.



## USING THE UNIT SAFELY

### WARNING

#### Do not use a CD-ROM in an audio CD player

DO NOT play a CD-ROM disc on a conventional audio CD player. The resulting sound may be of a level that could cause permanent hearing loss. Damage to speakers or other system components may result.



### CAUTION

#### Place in a well ventilated location

The unit and the AC adaptor should be located so their location or position does not interfere with their proper ventilation.



#### When disconnecting an AC adaptor, grasp it by the plug

To prevent conductor damage, always grasp the AC adaptor by its plug when disconnecting it from this unit or from a power outlet.



#### Periodically clean the AC adaptor's plug

At regular intervals, you should unplug the AC adaptor and clean it by using a dry cloth to wipe all dust and other accumulations away from its prongs. Also, disconnect the power plug from the power outlet whenever the unit is to remain unused for an extended period of time. Any accumulation of dust between the power plug and the power outlet can result in poor insulation and lead to fire.



#### Manage cables for safety

Try to prevent cords and cables from becoming entangled. Also, all cords and cables should be placed so they are out of the reach of children.



#### Avoid climbing on top of the unit, or placing heavy objects on it

Never climb on top of, nor place heavy objects on the unit.



#### Do not connect or disconnect the AC adaptor with wet hands

Never handle the AC adaptor or its plugs with wet hands when plugging into, or unplugging from, an outlet or this unit.



### CAUTION

#### Disconnect everything before moving the unit

Before moving the unit, disconnect the AC adaptor and all cords coming from external devices.



#### Unplug the AC adaptor from the outlet before cleaning

Before cleaning the unit, turn it off and unplug the AC adaptor from the outlet (p. 10).



#### If there is a possibility of lightning strike, disconnect the AC adaptor from the outlet

Whenever you suspect the possibility of lightning in your area, disconnect the AC adaptor from the outlet.



#### Keep small items out of the reach of children

To prevent accidental ingestion of the parts listed below, always keep them out of the reach of small children.

- Removable Parts  
Screws (p. 5)



#### Handle the ground terminal carefully

If you remove the screw from the ground terminal, be sure to replace it; don't leave it lying around where it could accidentally be swallowed by small children. When refastening the screw, make that it is firmly fastened, so it won't come loose.



#### Precautions concerning use of phantom power supply

Always turn the phantom power off when connecting any device other than condenser microphones that require phantom power. You risk causing damage if you mistakenly supply phantom power to dynamic microphones, audio playback devices, or other devices that don't require such power. Be sure to check the specifications of any microphone you intend to use by referring to the manual that came with it.



(This instrument's phantom power: 48 V DC, 10 mA Max)

# IMPORTANT NOTES

## Power Supply

- Do not connect this unit to same electrical outlet that is being used by an electrical appliance that is controlled by an inverter or a motor (such as a refrigerator, washing machine, microwave oven, or air conditioner). Depending on the way in which the electrical appliance is used, power supply noise may cause this unit to malfunction or may produce audible noise. If it is not practical to use a separate electrical outlet, connect a power supply noise filter between this unit and the electrical outlet.
- The AC adaptor will begin to generate heat after long hours of consecutive use. This is normal, and is not a cause for concern.
- To prevent malfunction and equipment failure, always make sure to turn off the power on all your equipment before you make any connections.

## Placement

- Using the unit near power amplifiers (or other equipment containing large power transformers) may induce hum. To alleviate the problem, change the orientation of this unit; or move it farther away from the source of interference.
- This device may interfere with radio and television reception. Do not use this device in the vicinity of such receivers.
- Noise may be produced if wireless communications devices, such as cell phones, are operated in the vicinity of this unit. Such noise could occur when receiving or initiating a call, or while conversing. Should you experience such problems, you should relocate such wireless devices so they are at a greater distance from this unit, or switch them off.
- Do not expose the unit to direct sunlight, place it near devices that radiate heat, leave it inside an enclosed vehicle, or otherwise subject it to temperature extremes. Excessive heat can deform or discolor the unit.
- When moved from one location to another where the temperature and/or humidity is very different, water droplets (condensation) may form inside the unit. Damage or malfunction may result if you attempt to use the unit in this condition. Therefore, before using the unit, you must allow it to stand for several hours, until the condensation has completely evaporated.
- Depending on the material and temperature of the surface on which you place the unit, its rubber feet may discolor or mar the surface. You can place a piece of felt or cloth under the rubber feet to prevent this from happening. If you do so, please make sure that the unit will not slip or move accidentally.

- Do not place containers or anything else containing liquid on top of this unit. Also, whenever any liquid has been spilled on the surface of this unit, be sure to promptly wipe it away using a soft, dry cloth.

## Maintenance

- For everyday cleaning wipe the unit with a soft, dry cloth or one that has been slightly dampened with water. To remove stubborn dirt, use a cloth impregnated with a mild, non-abrasive detergent. Afterwards, be sure to wipe the unit thoroughly with a soft, dry cloth.
- Never use benzene, thinners, alcohol or solvents of any kind, to avoid the possibility of discoloration and/or deformation.

## Repairs and Data

- Please be aware that all data contained in the unit's memory may be lost when the unit is sent for repairs. Important data should always be backed up a computer, or written down on paper (when possible). During repairs, due care is taken to avoid the loss of data. However, in certain cases (such as when circuitry related to memory itself is out of order), we regret that it may not be possible to restore the data, and Roland assumes no liability concerning such loss of data.

## Additional Precautions

- Please be aware that the contents of memory can be irretrievably lost as a result of a malfunction, or the improper operation of the unit. To protect yourself against the risk of losing important data, we recommend that you periodically save a backup copy of important data you have stored in the unit's memory on a computer.
- Unfortunately, it may be impossible to restore the contents of data that was stored in the unit's memory or a computer once it has been lost. Roland Corporation assumes no liability concerning such loss of data.
- Use a reasonable amount of care when using the unit's buttons, sliders, or other controls; and when using its jacks and connectors. Rough handling can lead to malfunctions.
- Never strike or apply strong pressure to the display.
- When disconnecting all cables, grasp the connector itself—never pull on the cable. This way you will avoid causing shorts, or damage to the cable's internal elements.
- To avoid disturbing others nearby, try to keep the unit's volume at reasonable levels.

## IMPORTANT NOTES

---

- When you need to transport the unit, package it in the box (including padding) that it came in, if possible. Otherwise, you will need to use equivalent packaging materials.
- Some connection cables contain resistors. Do not use cables that incorporate resistors for connecting to this unit. The use of such cables can cause the sound level to be extremely low, or impossible to hear. For information on cable specifications, contact the manufacturer of the cable.

### Handling CDs / DVDs

- Avoid touching or scratching the shiny underside (encoded surface) of the disc. Damaged or dirty discs may not be read properly. Keep your discs clean using a commercially available disc cleaner.

### Grounding

- Depending on the circumstances of a particular setup, you may experience a discomforting sensation, or perceive that the surface feels gritty to the touch when you touch this device, microphones connected to it, or the metal portions of other objects, such as guitars. This is due to an infinitesimal electrical charge, which is absolutely harmless. However, if you are concerned about this, connect the ground terminal (see figure) with an external ground. When the unit is grounded, a slight hum may occur, depending on the particulars of your installation. If you are unsure of the connection method, contact the nearest Roland Service Center, or an authorized Roland distributor, as listed on the "Information" page.



### Unsuitable places for connection

- Water pipes (may result in shock or electrocution)
- Gas pipes (may result in fire or explosion)
- Telephone-line ground or lightning rod (may be dangerous in the event of lightning)

### Copyrights/Licences/Trademarks

- Before you open the included CD-ROM, you must read the "license agreement." Opening the CD-ROM will be taken to mean your acceptance of the license agreement.
- MMP (Moore Microprocessor Portfolio) refers to a patent portfolio concerned with microprocessor architecture, which was developed by Technology Properties Limited (TPL). Roland has licensed this technology from the TPL Group.
- ASIO is a trademark and software of Steinberg Media Technologies GmbH.
- Microsoft product screen shot(s) reprinted with permission from Microsoft Corporation.
- Roland is an either registered trademark or trademark of Roland Corporation in the United States and/or other countries.
- Company names and product names appearing in this document are registered trademarks or trademarks of their respective owners.



# Index

## Symbols

- 48V ..... 20, 30
- [48V] button ..... 20
- 192 kHz ..... 53
- [⏻] (Power) button ..... 16, 17

## A

- ASIO ..... 25, 26
- ATTACK ..... 31
- Attenuator ..... 22
- Audio input device ..... 26
- Audio MIDI Setup (Mac OS X) ..... 56
- Audio output device ..... 25
- Auto Off ..... 17
- AUTO-SENS ..... 30, 39
- [AUTO-SENS] button ..... 21

## B

- Bass ..... 8, 20
- BYPASS ..... 31

## C

- Clock source ..... 36
- COAXIAL IN (15/16) jack ..... 9
- COAXIAL OUT (9/10) jack ..... 10
- Compressor ..... 19, 31
- [COMPRESSOR] button ..... 22
- Condenser mic ..... 8, 20
- Contrast ..... 43
- Control Panel
  - Initialize ..... 41

## D

- DAW monitor A–D ..... 34
- DAW software ..... 25
- DC IN jack ..... 10
- Device panel ..... 36
- Direct monitor ..... 23
- Direct monitor A–D ..... 33
- [DIRECT MONITOR] knob ..... 7
- [DIRECT OUT] switch ..... 9
- Driver
  - Delete ..... 68
- Dynamic microphone ..... 8

## E

- EXTERNAL ..... 36

## F

- Factory reset ..... 54

## G

- GAIN ..... 31
- GATE ..... 31
- GR indicator ..... 7
- Ground terminal ..... 76
- Guitar ..... 8, 20

## H

- Hi-Z ..... 20, 30

## I

- INPUT 1–12 jacks ..... 8
- INPUT 13–16 jacks ..... 9
- INPUT15/16 ..... 47
- INTERNAL ..... 36

## K

- KNEE ..... 31

## L

- LINE OUT 1L, 2R, 3–8 jacks ..... 10
- LINK ..... 34
- LoCUT ..... 30
- [LoCUT] button ..... 20

## M

- Main screen ..... 18, 24
- Master A–D ..... 34
- Mic ..... 20
- Mic preamp ..... 19
- MIDI input device ..... 26
- MIDI output device ..... 26
- MME/KS ..... 25
- Monitor mixer control screen ..... 32
- MONITOR OUT 1L, 2R jacks ..... 9
- [MONITOR OUT LEVEL] knob ..... 7
- MONITOR OUT level meter ..... 6
- MUTE ..... 33, 34

## O

- OUTPUT JACK ..... 34

## P

- PAN ..... 33, 34
- Patch Bay ..... 37
- Phantom power ..... 20
- PHASE ..... 30
- [PHASE] button ..... 20
- PHONES 1, 2 jacks ..... 7
- [PHONES LEVEL 1], [PHONES LEVEL 2] knobs ..... 7
- Preamp ..... 19, 30

- Preamp control screen ..... 30
- Preset ..... 31

## R

- Rack mount ..... 5
- Range Select ..... 19
- RATE ..... 31
- RELEASE ..... 31
- Reverb ..... 33, 35
- REVERB RETURN ..... 34
- REVERB TYPE ..... 34

## S

- Sampling rate ..... 36, 47, 53
- SENS ..... 30
- [SENS] knob ..... 20, 23
- Setting
  - Load ..... 38
  - Recall ..... 43
  - Save ..... 38
- SOLO ..... 33, 34
- STEREO ..... 30, 33, 34
- SYNC ..... 46, 47
- Synchronize ..... 46, 52
- SYSTEM screen ..... 43

## T

- THRESHOLD ..... 31
- [THRESHOLD] knob ..... 22

## U

- USB driver
  - Install ..... 11
  - Setting ..... 54

## V

- VS EXPAND ..... 47

## W

- WDM ..... 25, 26

For the U.K.

**IMPORTANT:** THE WIRES IN THIS MAINS LEAD ARE COLOURED IN ACCORDANCE WITH THE FOLLOWING CODE.

BLUE: NEUTRAL  
BROWN: LIVE

As the colours of the wires in the mains lead of this apparatus may not correspond with the coloured markings identifying the terminals in your plug, proceed as follows:  
The wire which is coloured BLUE must be connected to the terminal which is marked with the letter N or coloured BLACK.  
The wire which is coloured BROWN must be connected to the terminal which is marked with the letter L or coloured RED.  
Under no circumstances must either of the above wires be connected to the earth terminal of a three pin plug.

For EU Countries



This product complies with the requirements of EMC Directive 2004/108/EC.

For the USA

## FEDERAL COMMUNICATIONS COMMISSION RADIO FREQUENCY INTERFERENCE STATEMENT

This equipment has been tested and found to comply with the limits for a Class B digital device, pursuant to Part 15 of the FCC Rules. These limits are designed to provide reasonable protection against harmful interference in a residential installation. This equipment generates, uses, and can radiate radio frequency energy and, if not installed and used in accordance with the instructions, may cause harmful interference to radio communications. However, there is no guarantee that interference will not occur in a particular installation. If this equipment does cause harmful interference to radio or television reception, which can be determined by turning the equipment off and on, the user is encouraged to try to correct the interference by one or more of the following measures:

- Reorient or relocate the receiving antenna.
- Increase the separation between the equipment and receiver.
- Connect the equipment into an outlet on a circuit different from that to which the receiver is connected.
- Consult the dealer or an experienced radio/TV technician for help.

This device complies with Part 15 of the FCC Rules. Operation is subject to the following two conditions:

- (1) this device may not cause harmful interference, and
- (2) this device must accept any interference received, including interference that may cause undesired operation.

This equipment requires shielded interface cables in order to meet FCC class B limit.

Any unauthorized changes or modifications not expressly approved by the party responsible for compliance could void the user's authority to operate the equipment.

For Canada

### NOTICE

This Class B digital apparatus meets all requirements of the Canadian Interference-Causing Equipment Regulations.

### AVIS

Cet appareil numérique de la classe B respecte toutes les exigences du Règlement sur le matériel brouilleur du Canada.

For C.A. US (Proposition 65)

### WARNING

This product contains chemicals known to cause cancer, birth defects and other reproductive harm, including lead.

For the USA

## DECLARATION OF CONFORMITY Compliance Information Statement

Model Name : UA-1610  
Type of Equipment : USB Audio Interface  
Responsible Party : Roland Corporation U.S.  
Address : 5100 S. Eastern Avenue, Los Angeles, CA 90040-2938  
Telephone : (323) 890-3700

**For EU Countries**



- UK** This symbol indicates that in EU countries, this product must be collected separately from household waste, as defined in each region. Products bearing this symbol must not be discarded together with household waste.
- DE** Dieses Symbol bedeutet, dass dieses Produkt in EU-Ländern getrennt vom Hausmüll gesammelt werden muss gemäß den regionalen Bestimmungen. Mit diesem Symbol gekennzeichnete Produkte dürfen nicht zusammen mit den Hausmüll entsorgt werden.
- FR** Ce symbole indique que dans les pays de l'Union européenne, ce produit doit être collecté séparément des ordures ménagères selon les directives en vigueur dans chacun de ces pays. Les produits portant ce symbole ne doivent pas être mis au rebut avec les ordures ménagères.
- IT** Questo simbolo indica che nei paesi della Comunità europea questo prodotto deve essere smaltito separatamente dai normali rifiuti domestici, secondo la legislazione in vigore in ciascun paese. I prodotti che riportano questo simbolo non devono essere smaltiti insieme ai rifiuti domestici. Ai sensi dell'art. 13 del D.Lgs. 25 luglio 2005 n. 151.
- ES** Este símbolo indica que en los países de la Unión Europea este producto debe recogerse aparte de los residuos domésticos, tal como está regulado en cada zona. Los productos con este símbolo no se deben depositar con los residuos domésticos.
- PT** Este símbolo indica que nos países da UE, a recolha deste produto deverá ser feita separadamente do lixo doméstico, de acordo com os regulamentos de cada região. Os produtos que apresentem este símbolo não deverão ser eliminados juntamente com o lixo doméstico.
- NL** Dit symbool geeft aan dat in landen van de EU dit product gescheiden van huishoudelijk afval moeten worden aangeboden, zoals bepaald per gemeente of regio. Producten die van dit symbool zijn voorzien, mogen niet samen met huishoudelijk afval worden verwijderd.
- DK** Dette symbol angiver, at i EU-lande skal dette produkt opsamlles adskilt fra husholdningsaffald, som defineret i hver enkelt region. Produkter med dette symbol må ikke smides ud sammen med husholdningsaffald.
- NO** Dette symbolet indikerer at produktet må behandles som spesialavfall i EU-land, iht. til retningslinjer for den enkelte regionen, og ikke kastes sammen med vanlig husholdningsavfall. Produkter som er merket med dette symbolet, må ikke kastes sammen med vanlig husholdningsavfall.

- SE** Symbolen anger att i EU-länder måste den här produkten kasseras separat från hushållsavfall, i enlighet med varje regions bestämmelser. Produkter med den här symbolen får inte kasseras tillsammans med hushållsavfall.
- FI** Tämä merkintä ilmaisee, että tuote on EU-maissa kerättävä erillään kotitalousjätteistä kunkin alueen voimassa olevien määräysten mukaisesti. Tällä merkinnällä varustettuja tuotteita ei saa hävittää kotitalousjätteiden mukana.
- HU** Ez a szimbólum azt jelenti, hogy az Európai Unióban ezt a terméket a háztartási hulladéktól elkülönítve, az adott régióban érvényes szabályozás szerint kell gyűjteni. Az ezzel a szimbólummal ellátott termékeket nem szabad a háztartási hulladék közé dobni.
- PL** Symbol oznacza, że zgodnie z regulacjami w odpowiednim regionie, w krajach UE produkty te należy wyrzucać z odpadami domowymi. Produktów opatrzonych tym symbolem nie można utylizować razem z odpadami domowymi.
- CZ** Tento symbol udává, že v zemích EU musí být tento výrobek sbíráán odděleně od domácího odpadu, jak je určeno pro každý region. Výrobky nesoucí tento symbol se nesmí vyhazovat spolu s domácím odpadem.
- SK** Tento symbol vyjadruje, že v krajinách EÚ sa musí zber tohto produktu vykonávať oddelene od domového odpadu, podľa nariadení platných v konkrétnej krajine. Produkty s týmto symbolom sa nesmú vyhazovať spolu s domovým odpadom.
- EE** See sümbol näitab, et EL-i maades tuleb see toode olemprigast eraldi koguda, nii nagu on igas piirkonnas määratletud. Selle sümboliga märgitud tooteid ei tohi ära visata koos olmeprügiga.
- LT** Šis simbolis rodo, kad ES šalyse šis produktas turi būti surenkamas atskirai nuo buitinii atliekų, kaip nustatyta kiekviename regione. Šiuo simboliu paženklinoti produktai neturi būti išmetami kartu su buitinėmis atliekomis.
- LV** Šis simbols norāda, ka ES valstīs šo produktu jāievieš atsevišķi no mājsaimniecības atkritumiem, kā noteikts katrā reģionā. Produkts ar šo simboliu nedrīkst izmest kopā ar mājsaimniecības atkritumiem.
- SI** Ta simbol označuje, da je treba proizvod v državah EU zbirati ločeno od gospodinskih odpadkov, tako kot je določeno v vsaki regiji. Proizvoda s tem znakom ni dovoljeno odlagati skupaj z gospodinskimi odpadki.
- GR** Το σύμβολο αυτό υποδηλώνει ότι στις χώρες της Ε.Ε. το συγκεκριμένο προϊόν πρέπει να συλλέγεται χωριστά από τα υπόλοιπα οικιακά απορρίμματα, σύμφωνα με όσα προβλέπονται σε κάθε περιοχή. Τα προϊόντα που φέρουν το συγκεκριμένο σύμβολο δεν πρέπει να απορρίπτονται μαζί με τα οικιακά απορρίμματα.

**For China**

**有关产品中所含有害物质的说明**

本资料就本公司产品中所含的特定有害物质及其安全性予以说明。  
本资料适用于 2007 年 3 月 1 日以后本公司所制造的产品。

**环保使用期限**



此标志适用于在中国国内销售的电子信息产品，表示环保使用期限的年限。所谓环保使用期限是指在自制造日起的规定期限内，产品中所含的有害物质不致引起环境污染，不会对人身、财产造成严重的不良影响。环保使用期限仅在遵照产品使用说明书，正确使用产品的条件下才有效。不当的使用，将会导致有害物质泄漏的危险。

**产品中有毒有害物质或元素的名称及含量**

部件名称	有毒有害物质或元素					
	铅(Pb)	汞(Hg)	镉(Cd)	六价铬(Cr(VI))	多溴联苯(PBB)	多溴二苯醚(PBDE)
外壳(壳体)	×	○	○	○	○	○
电子部件(印刷电路板等)	×	○	×	○	○	○
附件(电源线、交流适配器等)	×	○	○	○	○	○

○：表示该有毒有害物质在该部件所有均质材料中的含量均在 SJ/T11363-2006 标准规定的限量要求以下。  
×：表示该有毒有害物质至少在该部件的某一均质材料中的含量超出 SJ/T11363-2006 标准规定的限量要求。  
因根据现有的技术水平，还没有什么物质能够代替它。

