

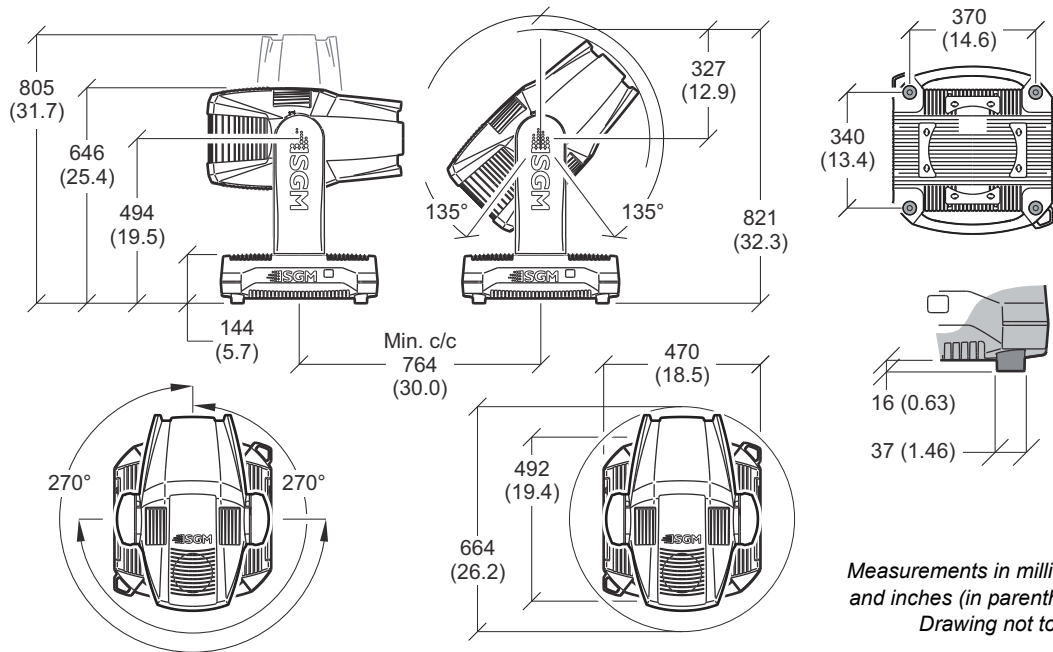

**G-SPOT
MOVING HEAD**



Dimensions



G-SPOT USER MANUAL

© 2015 SGM®. Information subject to change without notice. SGM and all affiliated companies disclaim liability for any injury, damage, direct or indirect loss, consequential or economic loss or any other loss occasioned by the use of, inability to use or reliance on the information contained in this manual.

The SGM logo, the SGM name and all other trademarks in this document pertaining to services or products by SGM or its affiliates and subsidiaries are trademarks owned or licensed by SGM or its affiliates or subsidiaries.

The original edition of this document is in English. All other language editions are translations of the original edition.

This edition applies to firmware version 1.00 or later.

Ver. F

Contents

Dimensions	2
Safety information	7
Overview	10
Unpacking	11
<i>Transportation</i>	11
Installation / Rigging	12
Connecting AC power	14
Control panel operations	15
<i>Using the control panel</i>	15
<i>DMX start address</i>	15
<i>Selecting module (G-Spot or G-Profile)</i>	15
<i>Configuring the device using an Android telephone via RFID</i>	16
Connecting to a DMX control device	17

Configuring the device for DMX control	18
<i>About DMX</i>	18
<i>Setting the DMX address</i>	18
Control panel menus	19
Gobo replacement	28
<i>Identification of gobo wheel</i>	28
<i>Replacing rotating gobos</i>	29
<i>How to replace a gobo in a gobo holder</i>	30
Maintenance	31
<i>Upgrading the firmware</i>	31
<i>Cleaning</i>	31
DMX protocols	32
<i>24 Channel Mode (Standard)</i>	32
<i>30 Channel Mode (Extended)</i>	44
<i>Full Color Calibration and Color Temperature Correction</i>	56

Effects	57
<i>Two independent rotating gobo wheels</i>	57
<i>Effect wheels</i>	57
<i>High-precision pan and tilt</i>	57
<i>Ultra high-speed strobe effect</i>	57
<i>Prism</i>	57
<i>Frost</i>	57
Fixtures and accessories	58
<i>Included items</i>	58
<i>Ordering information</i>	58
User's notes	60

Safety information



WARNING! Read the safety precautions in this section before unpacking, installing, powering or operating this product.

The G-SPOT is intended for professional use only. It is not suitable for household use. **Impropre a l'usage domestique.**

Review the following safety precautions carefully before installing or operating the fixture. This product must be installed in accordance with the applicable installation code by a person familiar with the construction and operation of the product and the hazards involved. **Ce produit doit être installé selon le code d'installation pertinent, par une personne qui connaît bien le produit et son fonctionnement ainsi que les risques inhérent.**

Preventing electric shock



WARNING! Risk of electric shock.

- Always power off/unplug the fixture before removing covers or dismantling product.
- Ensure that the mains power is off when wiring the fixture to the AC mains supply.
- Ensure that the fixture is electrically connected to earth (ground).
- Do not apply power if the fixture is in any way damaged.
- Do not immerse the fixture in water or liquid.

Preventing burns and fire



WARNING! Take measures to prevent burns and fire.

- Install in a location that prevents accidental contact with the fixture.
- Install only in a well-ventilated space.
- Install at least 0.3 m (12 in.) away from objects to be illuminated.
- Install only in accordance with applicable building codes.
- Ensure a minimum clearance of 0.1 m (4 in.) around the cooling fans.
- Do not paint, cover or modify the fixture.
- Keep all flammable materials away from the fixture.
- Allow the fixture to cool for 15 minutes after operation, before touching it.

CAUTION: Exterior surface temperature after 5 min. operation = 55° C (131° F). Steady state = 65° C (149° F)

Avoid personal injury



WARNING! Take measures to prevent personal injury.

- Do not look directly at the light source from close range.
- Take precautions to prevent injury when working at height.
- Ensure that the fixture is always securely fastened with suitable hardware.
- For elevated installations, secure the fixture with suitable safety cables, and always comply with relevant load dimensioning, safety standards and requirements.

Overview

The SGM G-Spot model is a maintenance free, multi-environmental fixture with an IP-rating of 65. It has a powerful LED light source, and a virtually unlimited color palette, two independent rotating gobo wheels and can easily be controlled by wired and wireless DMX. The fixture also offers RFID and NFC, low power consumption and an expected lifetime of the multiple LED's of 50,000 hours*.

- A : Pan lock
- B : Tilt lock
- C : Base handle
- D : Head fan grill (one of two shown)
- E : Display panel
- F : Safety wire attachment point
- G : Fuse
- H : DMX in
- I : DMX out
- J : Power in
- K : Power cord

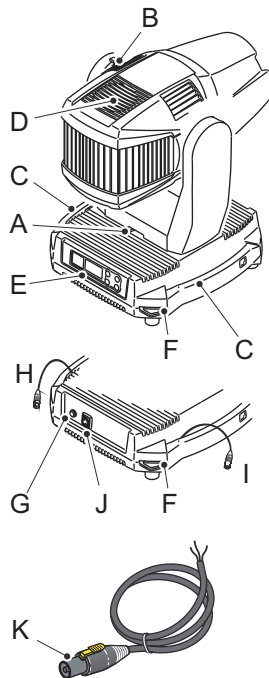

* At 70% of luminous output under the manufacturer's test conditions.

Unpacking

Unpack the fixture and inspect it to ensure that it has not been damaged in transport.

The G-Spot is supplied with:

- User manual.
- One Neutrik TRUE1 power input connector, 2 m (78 in.)
- Two Omega brackets with 1/4-turn fasteners.

The fixture is designed for use in wet locations and is IP65-rated. When selecting a location for the fixture, ensure that:

- it is situated away from public thoroughfares and protected from contact with people.
- it has adequate ventilation.

Transportation

Always use the supplied packaging for transportation and storage.

Release the pan/tilt locks when transporting the fixture. Leaving the pan/tilt locks applied may cause damage to the fixture.

Installation / Rigging



WARNING! Always secure elevated fixtures with a safety cable.

The G-Spot may be installed in any orientation.

Always use two Omega brackets to rig the fixture. Lock each bracket with both 1/4-turn fasteners. The fasteners are locked only when turned fully clockwise.

Always fasten safety cables between the load-bearing support structure and the attachment points on the fixture. The safety cables must be able to bear at least 10 times the weight of the fixture.

CAUTION:

- Always use two safety wires.
- Min. safety wire gauge = 5 mm.
- Max. safety wire length (free fall) = 30 cm (11 in.)
- Make sure the slack of the safety wire is at a minimum.
- Never use the carrying handles for secondary attachment.

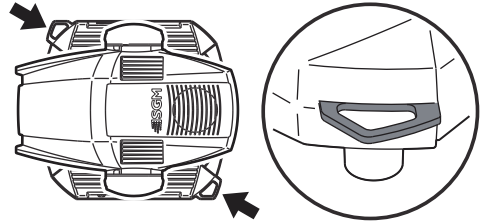
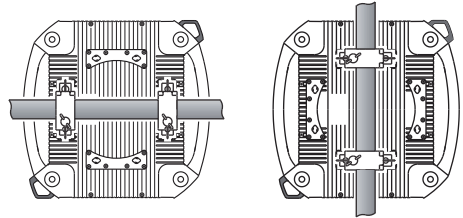

Start the rigging process by blocking the work area below, and make sure the work is performed from a stable platform.

- 1 Check that the clamps are undamaged and can bear at least 10 times the weight of the fixture. Check that the structure can bear at least 10 times the weight for all installed fixtures, clamps, cables etc.
- 2 Bolt each clamp securely to an Omega bracket with an M12 / 1/2" bolt (min. grade 8.8) and lock nut.
- 3 Align an Omega bracket with two 1/4-turns in the base. Insert the fasteners into the base and turn both levers a full 1/4-turn clockwise to lock. Install the second Omega bracket.
- 4 Working from a stable platform, hang the fixture on a truss, or other structure. Note the position of the base. The front of the base is to the right, when looking at the display panel, and when the fixture is sitting on the base. Tighten the clamps.
- 5 Install two safety wires that each can bear at least 10 times the weight of the unit. The attachment points are designed to fit a carabiner.
- 6 Check that the pan/tilt locks are released (A and B). Verify that there are no combustible materials or surfaces to be illuminated within 0.3 m (11 in.) of the fixture.
- 7 Check that there is no possibility of head or yoke colliding with other fixtures.

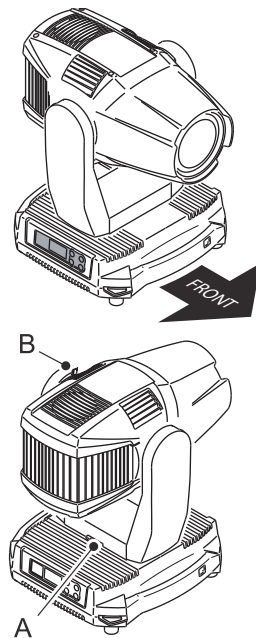

Connecting AC power

The G-Spot can operate on any 200-240V, 50/60 Hz mains power supply

Connect the fixture to power using a cable with a Neutrik powerCON TRUE1 connector (supplied with the fixture). Connect both DMX in and DMX out cables in order to maintain the fixture IP65.

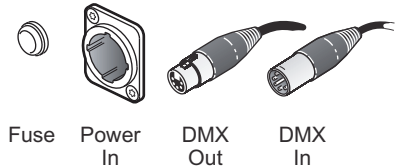
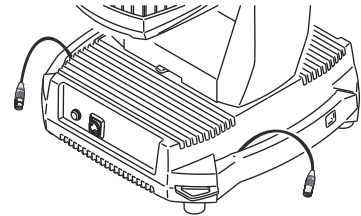



Fuse

Power
In

DMX
Out

DMX
In

The fixture must be grounded/earthed and be able to be isolated from AC power. The AC power supply must incorporate a fuse or circuit breaker for fault protection.

<i>Wire</i>	<i>Color</i>	<i>Symbol</i>	<i>Conductor</i>
	Black	L	live
	White	N	neutral
	Green	⏏ or ⏚	ground (earth)

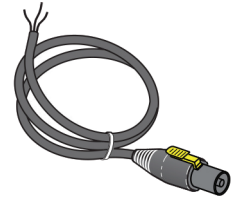

Control panel operations

You can configure individual fixture settings, read out data and view error messages in the graphic display.

When the fixture is powered on, it boots and resets, then displays the DMX start address and any status messages.

Using the control panel

- Click the arrow buttons to scroll up and down menus.
- Click the OK button to enter a menu or make a selection.
- Press the ESC button to step backwards through the menus.

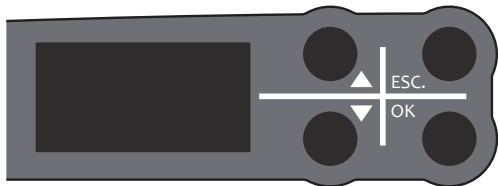

DMX start address

The DMX start address is the first channel used to receive instructions from the controller. For independent control, each fixture must be assigned its own start address. If you give two fixtures the same address, they will behave identically. Address sharing can be useful for diagnostic purposes and symmetrical control.

Select DMX address using the arrow buttons.

Selecting module (G-Spot or G-Profile)

If you replace the fixture's module in order to switch from a G-Spot to a G-Profile or vice-versa, you need to change the fixture's software settings.

In the Control Menu, go to 'Settings→Service Menu→Fixture Type' and select the fixture you are currently using.

NOTE: To access "Service Menu→Fixture Type", you need to type in the value '0110' under 'Settings→Service Pin'. See "Control panel menus" on page 19 for more details.

Configuring the device using an Android telephone via RFID

The G-Spot can also be configured wirelessly, via RFID, using the SGM Tool app installed on an Android smart phone that has NFC support (ISO 15693 and ISO 18000-3 mode 1 compatible, operating on 13.56 MHz \pm 7k Hz carrier frequency).

Connecting to a DMX control device

The G-Spot is controllable using a DMX control device and it can be connected using either a DMX cable or via the fixture's built-in LumenRadio CRMX wireless receiver system.

If using a cabled DMX system, connect the DMX in cable (with male 5-pin XLR plug) and out cable (with female 5-pin XLR plug) to the DMX data link. Terminate the DMX out cable of the last fixture in the data link. For outdoor installations, use only IP-rated XLR connectors suitable for outdoor use.

Configuring the device for DMX control

About DMX

The G-Spot can be controlled using signals sent by a DMX controller on a number of channels (which varies depending on the DMX mode that has been set).

The first channel used to receive data from a DMX control device is known as the DMX start address. Each G-Spot must have a DMX start address set. For example, if a fixture has a DMX address of 10 and it is in 3-channel DMX mode, then it uses channels 10, 11, and 12. The following device in the DMX chain could then be set to a DMX address of 13. If two or more DMX devices of the same type have the same DMX address, then they will mimic each other's behavior. Incorrect settings will result in unpredictable responses to the lighting controller.

Setting the DMX address

The DMX address can be seen on the OLED display. To change the address setting, press the up and down arrows. When the desired address is displayed, press 'OK' to save the setting. For your convenience, the suggested DMX address of the next device is displayed to the right. Note that channel spacing is determined by the DMX mode.

See the "DMX protocols" on page 32 for specific DMX control values

Control panel menus

Level 1	Level 2	Level 3	Level 4	Info
DMX MODE	STANDARD			
	EXTENDED			
INFO	GENERAL INFO	PRODUCT: SN: RDM LABEL RDM ID		
	SOFTWARE VERSION	MAIN: SMPS: PAN: TILT: GOBO: ZOOM:		

Level 1	Level 2	Level 3	Level 4	Info
INFO (continued)	TIMERS	RED GREEN BLUE RUNNING HOURS	D: H: D: H: D: H: D: H:	
	DMX VIEW	001 - ↓ 507 -		
	TEMPERATURES	LED SMPS PAN: GOBO: BASE: HUMIDITY	R: G: B: TILT: FOCUS: HEAD: B: H:	

Level 1	Level 2	Level 3	Level 4	Info
INFO (continued)	FANS	LED FAN 1: LED FAN 2: HEAD: BASE:	rpm rpm rpm rpm	
	LOG	FIRMWARE: BUILD: BUILD: UPTIME:	D: H: M: S:	
	DEBUG	0 - ↓ 54 -		

Level 1	Level 2	Level 3	Level 4	Info
INFO (continued)	ERRORS	SMPS PAN TILT GOBO ZOOM		
SETTINGS	WIRELESS DMX	LOG OFF		
		STATUS	SIGNAL STRENGTH % CRMX PAIRD: RDM ACTIVE: DMX ACTIVE: CRMX RATE Hz	
		ENABLE/DISABLE		
		CRMX → DMX		

Level 1	Level 2	Level 3	Level 4	Info
SETTINGS (continued)	DIMMING CURVE	LINEAR () GAMMA CORRECTED (X)		
	INVERT PAN ()			
	INVERT TILT ()			
	SWAP PAN TILT ()			
	FLIP DISPLAY ()			
	DISPLAY OFF ()			
	FAN MODE	STANDARD SILENT MAX POWER ALWAYS 100%		

Level 1	Level 2	Level 3	Level 4	Info
SETTINGS (continued)	CALIBRATION	PAN HOME	CALIBRATION → XXXXX PAN POS XXXX - REV. X.XX	
		TILT HOME	CALIBRATION → XXXXX PAN POS XXXX - REV. X.XX	
		GOBO SELECT 1	CALIBRATION → XXXXX	
		GOBO SELECT 2	CALIBRATION → XXXXX	
		EFFECT WHEEL 1	CALIBRATION → XXXXX	

Level 1	Level 2	Level 3	Level 4	Info
SETTINGS (continued)	CALIBRATION (continued)	EFFECT WHEEL 2	CALIBRATION → XXXXX	
		FROST	CALIBRATION → XXXXX	
		PRISM	CALIBRATION → XXXXX	
		IRS	CALIBRATION → XXXXX	
		ZOOM	CALIBRATION → XXXXX	
		FOCUS	CALIBRATION → XXXXX	
	SERVICE PIN			

Level 1	Level 2	Level 3	Level 4	Info
SETTINGS (continued)	SERVICE MENU	FIXTURE DEFAULT		
		DEBUG		
	FACTORY DEFAULT	FACTORY DEFAULT SET		
TEST	OFF			
	AUTOMATED TEST			
	LED TEST	TESTING RED 2		
		TESTING RED 1		
		TESTING BLUE 2		
		TESTING BLUE 1		
		TESTING YELLOW		
		TESTING GREEN		
DISPLAY TEST				

Level 1	Level 2	Level 3	Level 4	Info
RESET¹	PAN TILT			
	GOBO MODULE			
	ZOOM FOCUS MODULE			
	ALL			

1. If the G-Spot is subjected to extreme exposure, the fixture might not reset correctly. If this happens, the fixture will automatically heat up the gobo bearings at maximum light output for approx. five minutes and attempt to reset the fixture again. Should this not resolve the issue, disconnect the fixture from power, and power it back on again to repeat the heat-up procedure. Should this not solve the issue, contact your local SGM distributor or SGM Technical Support. See <http://sgmlight.com/service-aftersales/> for more details.

Gobo replacement

Identification of gobo wheel

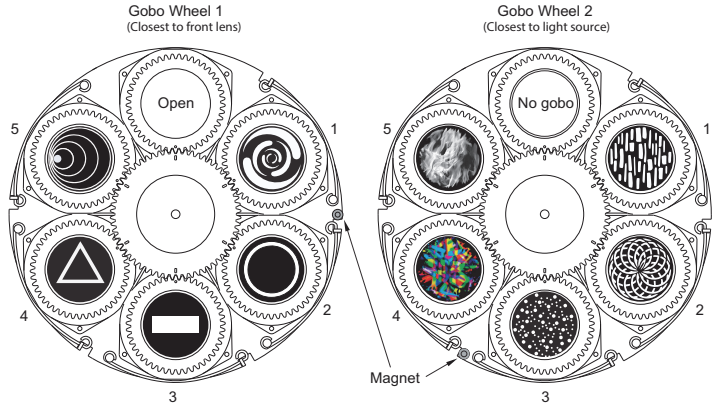

Gobo Wheel 1:		
No.	Description	Part No.
Open	Open gobo	37000001
1	Spin cycle	37005002
2	Ring	37005007
3	Bar	37005008
4	Triangle	37005009
5	Concentric	37005004

Gobo Wheel 2:		
No.	Description	Part No.
No gobo	No gobo	37000001
1	Breakup bricks	37005006
2	Spiral leaf	37005010
3	Dots	37005003
4	Kaleidoscope gems	37002001
5	Fire up close	37005001

Replacing rotating gobos

To replace one or more gobos:

- Disconnect the fixture from power and allow to cool.
- Position the head and apply the tilt lock.
- Before removing one of the rear head covers, identify where gobo wheel covers 1 and 2 are positioned. When the head of the fixture is facing upwards, cover gobo wheel 2 is located at the side of the head corresponding to the pan lock (A). See figure below.
- Remove the relevant rear head cover.
- Remove the gobo wheel cover for access to the gobo wheel.
- Turn the relevant gobo wheel until the gobo you want to replace is accessible.
- Unhook the end of the spring and turn it upwards. Pull the gobo holder out of the gobo wheel.

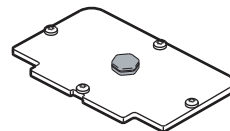
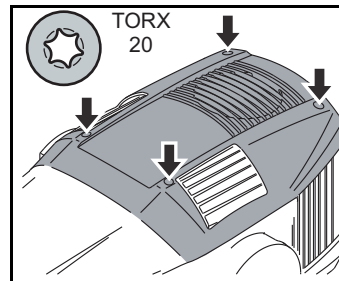

Cover Gobo Wheel 1

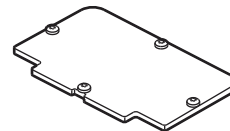

Cover Gobo Wheel 2

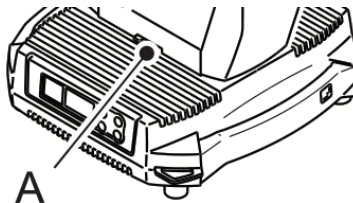

How to replace a gobo in a gobo holder

- Place gobo with silver side towards the light source.
- Align index markers on the gobo and the gobo holder as shown below.
- Insert the gobo holder and align it with the index marker on the gobo wheel as shown below. If necessary, continue replacing gobos one by one as described above. If no further service is necessary, reinstall the gobo wheel cover. To maintain the fixture's IP65 rating, it is important to fasten the gobo covers to 1 Nm.

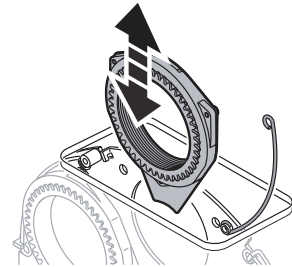
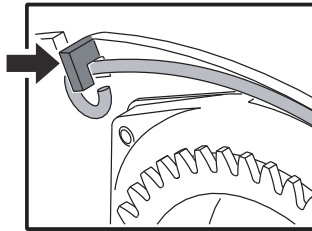
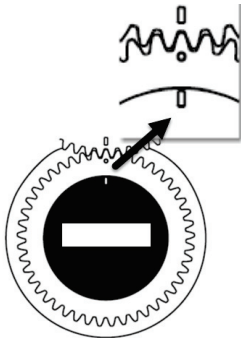
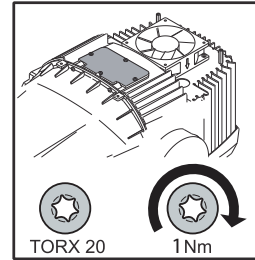

Maintenance

When cleaning the fixture, do not use any product that contains abrasives or solvents that can damage plastic or painted surfaces. Use a clean cloth with water and a standard household cleaner.

To maintain adequate cooling, fans must be cleaned periodically.

Upgrading the firmware

The firmware installed on the fixture can be identified using the “Info→Software version” menu. We recommend that you keep your fixture’s firmware up-to-date. Visit <http://www.sgmlight.com> to download the latest firmware.

To perform firmware updates, you need a Windows-based personal computer and a SGM USB 5-Pin-XLR upload cable (available from your SGM distributor).

Cleaning

To maintain optimal performance, regular cleaning is essential. Cleaning schedules will vary greatly depending on the operating environment, and the installation should therefore be checked at frequent intervals within the first few weeks of operation to see whether cleaning is necessary. This procedure will allow you to assess cleaning requirements in your particular situation. If in doubt, consult your SGM dealer for a suitable maintenance schedule.

Setting the OLED display saver

By default the OLED display dims down after a short period when the control panel is not in use, but it can also be set to turn off completely. Pressing any key will always turn on the display or restore it to normal brightness. To change the display saver, use the “Settings→Display Off” menu.

NOTE: To avoid the risk of display deterioration caused by long term use in permanent installations, it is recommended to use the “Settings→Display Off” setting.

DMX protocols

24 Channel Mode (Standard)									
Channel	Name	DMX Value		DMX Percentage		Description	Info	Default DMX Value	Fader Type
1	Shutter	0	7	0,0%	2,7%	Closed		10 (3,9%)	Snap
		8	15	3,1%	5,9%	Open			
		16	151	6,3%	59,2%	Strobe	Slow > Fast		
		152	175	59,6%	68,6%	Pulse - Open	Slow > Fast		
		176	199	69,0%	78,0%	Pulse - Close	Slow > Fast		
		200	244	78,4%	95,7%	Strobe - Random	Slow > Fast		
		245	255	96,1%	100,0%	Open			
2	Intensity	0	255	0,0%	100,0%	No light > Maximum light		0 (0%)	Fade
3	Red	0	255	0,0%	100,0%	No RED > Maximum RED		0 (0%)	Fade

24 Channel Mode (Standard)

Channel	Name	DMX Value	DMX Percentage	Description	Info	Default DMX Value	Fader Type
4	Green	0 255	0,0% 100,0%	No GREEN > Maximum GREEN		0 (0%)	Fade
5	Blue	0 255	0,0% 100,0%	No BLUE > Maximum BLUE		0 (0%)	Fade
6	CTC	0 4	0,0% 1,6%	No CTC			
		5 5	2,0% 2,0%	≈ 2000° K			
		15 15	5,9% 5,9%	≈ 2200° K (High Pressure Sodium Lamp)			
		40 40	15,7% 15,7%	≈ 2700° K (Incandescent Lamp)			
		54 54	21,2% 21,2%	≈ 3000° K (Halogen / Tungsten Lamp)			

24 Channel Mode (Standard)

Channel	Name	DMX Value	DMX Percentage	Description	Info	Default DMX Value	Fader Type	
6	CTC	65	65	25,5%	25,5%	≈ 3200° K (Warm Metal Halide Lamp)	0(0%)	Fade
		105	105	41,2%	41,2%	≈ 4000° K (Clear Metal Halide Lamp)		
		115	115	45,1%	45,1%	≈ 4200° K (Cool White Fluorescent Lamp)		
		177	177	69,4%	69,4%	≈ 5500° K (Daylight Metal Halide Lamp)		
		216	216	84,7%	84,7%	≈ 6300° K		
		238	238	93,3%	93,3%	≈ 8000° K		
		255	255	100,0%	100,0%	≈ 10,000° K		

24 Channel Mode (Standard)

Channel	Name	DMX Value	DMX Percentage	Description	Info	Default DMX Value	Fader Type
7 8	Pan	0 65535	0,0% 100,0%	-270° to 270°	-270° = Front Lens @ Mains Power Input (Tilt=0)	32767 (50%)	Fade
9 10	Tilt	0 65535	0,0% 100,0%	-120° to 120°	-120° = Front Lens @ Base Front (Pan=32767)	32767 (50%)	Fade
11	Gobo Wheel 1 (closest to light source)	0 20	0,0% 7,8%	Open		0 (%)	Snap
		21 41	8,2% 16,1%	Gobo 1 - Position 1			
		42 62	16,5% 24,3%	Gobo 1 - Position 2			
		63 83	24,7% 32,5%	Gobo 1 - Position 3			
		84 104	32,9% 40,8%	Gobo 1 - Position 4			
		105 127	41,2% 49,8%	Gobo 1 - Position 5			

24 Channel Mode (Standard)

Channel	Name	DMX Value	DMX Percentage	Description	Info	Default DMX Value	Fader Type		
11	Gobo Wheel 1 (closest to light source)	128	191	50,2%	74,9%	Gobo Wheel Continuous Rotation CW	Fast > Slow	0 (0%)	Snap
		192	192	75,3%	75,3%	No Rotation			
		193	255	75,7%	100,0%	Gobo Wheel Continuous Rotation CCW	Slow > Fast		
12 13	Gobo Wheel 1 Indexing Rotation Shake	0	32767	0,0%	50,0%	Gobo Index		0 (0%)	Fade
		32768	32799	50,0%	50,0%	No Effect			
		32800	46418	50,0%	70,8%	Gobo Continuous Rotation CW	Fast > Slow		
		46419	46919	70,8%	71,6%	No Rotation			

24 Channel Mode (Standard)

Channel	Name	DMX Value	DMX Percentage	Description	Info	Default DMX Value	Fader Type
12 13	Gobo Wheel 1 Indexing Rotation Shake	46920 60538	71,6% 92,4%	Gobo Continuous Rotation CW	Slow > Fast	0 (0%)	Fade
		60539 65535	92,4% 100,0%	Gobo Shake	Slow >Fast		
14	Gobo Wheel 2 (closest to front lens)	0 20	0,0% 7,8%	Open		0 (%)	Snap
		21 41	8,2% 16,1%	Gobo 2 - Position 1			
		42 62	16,5% 24,3%	Gobo 2 - Position 2			
		63 83	24,7% 32,5%	Gobo 2 - Position 3			
		84 104	32,9% 40,8%	Gobo 2 - Position 4			
		105 127	41,2% 49,8%	Gobo 2 - Position 5			

24 Channel Mode (Standard)

Channel	Name	DMX Value	DMX Percentage	Description	Info	Default DMX Value	Fader Type		
14	Gobo Wheel 2 (closest to front lens)	128	191	50,2%	74,9%	Gobo Wheel Continuous Rotation CW	Fast > Slow	0 (0%)	Snap
		192	192	75,3%	75,3%	No Rotation			
		193	193	75,7%	100,0%	Gobo Wheel continuous rotation CCW	Slow >Fast		
15 16	Gobo Wheel 2 Indexing Rotation Shake	0	32767	0,0%	50,0%	Gobo Index		0 (0%)	Fade
		32768	32799	50,0%	50,0%	No Effect			
		32800	46418	50,0%	70,8%	Gobo Continuous Rotation CW	Fast > Slow		
		46419	46919	70,8%	71,6%	No Rotation			

24 Channel Mode (Standard)

Channel	Name	DMX Value	DMX Percentage	Description	Info	Default DMX Value	Fader Type
15 16	Gobo Wheel 2 Indexing Rotation Shake	46920 60538	71,6% 92,4%	Gobo Continuous Rotation CW	Slow > Fast	0 (0%)	Fade
		60539 65535	92,4% 100,0%	Gobo Shake	Slow >Fast		
17	Iris	0 200	0,0% 78,4%	Open > Close		0 (0%)	Fade
		201 205	78,8% 80,4%	Effect - "Open fast / Close slow"			
		206 210	80,8% 82,4%	Effect - "Open slow / Close fast"			
		211 215	82,7% 84,3%	Effect - "Open / Close"		0 (0%)	Fade
		216 255	84,7% 100,0%	Effect - "Random Close / Open"	Slow > Fast		

24 Channel Mode (Standard)

Channel	Name	DMX Value	DMX Percentage	Description	Info	Default DMX Value	Fader Type		
18	Effect Wheel	0	4	0,0%	1,6%	Open	0 (0%)	Fade	
		5	127	2,0%	49,8%	Indexed			
		128	153	50,2%	60,0%	Continuous rotation CW			Fast > Slow
		154	179	60,4%	70,2%	Continuous rotation CCW			Slow > Fast
		180	255	70,6%	100,0%	Reserved (calibration position)			
19	Prism	0	4	0,0%	1,6%	Open	0 (0%)		
		5	129	2,0%	50,6%	Continuous Rotation CW			Fast > Slow
		130	130	51,0%	51,0%	No Rotation			
		131	255	51,4%	100,0%	Continuous Rotation CCW			Slow > Fast

24 Channel Mode (Standard)

Channel	Name	DMX Value	DMX Percentage	Description	Info	Default DMX Value	Fader Type	
20	Frost	0	5	0,0%	2,0%	Open	0 (0%)	Fade
		6	255	2,4%	100,0%			
21	Zoom	0	255	0,0%	100,0%	Wide > Narrow	0 (0%)	Fade
22	Focus	0	255	0,0%	100,0%	Far > Near	0 (0%)	Fade
23	Effect Channel	0	4	0,0%	1,6%	No Effect	0 (0%)	Snap
		5	15	2,0%	5,9%	Reserved (No Effect)		
		16	26	6,3%	10,2%	Reserved (No Effect)		
		27	32	10,6%	12,5%	Shutter Black = RED		
		33	38	12,9%	14,9%	Shutter Black = GREEN		
		39	44	15,3%	17,3%	Shutter Black = BLUE		

24 Channel Mode (Standard)

Channel	Name	DMX Value	DMX Percentage	Description	Info	Default DMX Value	Fader Type		
23	Effect Channel	45	50	17,6%	19,6%	Shutter Black = WHITE	0 (0%)	Snap	
		51	56	20,0%	22,0%	Shutter Black = Magenta			
		57	62	22,4%	24,3%	Shutter Black = Yellow			
		63	68	24,7%	26,7%	Shutter Black = Cyan			
		69	255	27,1%	100,0%	Reserved (No Effect)			
24	Control Channel	0	4	0,0%	1,6%	No Function	0 (0%)	Snap	
		5	9	2,0%	3,5%	Full Reset			Hold 3 seconds
		10	14	3,9%	5,5%	Pan Reset			Hold 3 seconds
		20	24	7,8%	9,4%	Gobo Reset			Hold 3 seconds

24 Channel Mode (Standard)

Channel	Name	DMX Value	DMX Percentage	Description	Info	Default DMX Value	Fader Type	
24	Control Channel	25	29	9,8% 11,4%	Zoom Reset	Hold 3 seconds	0 (0%)	Snap
		30	34	11,8% 13,3%	Sleep Mode	See note ¹		
		35	39	13,7% 15,3%	Display Off	Hold 3 seconds		
		40	44	15,7% 17,3%	Display On	Hold 3 seconds		
		45	255	17,6% 100,0%	Reserved (No Function)			

1. All other channels must be zero and this has to be held for 30 sec. (fixture will wake up on a full reset).

30 Channel Mode (Extended)

Channel	Name	DMX Value	DMX Percentage	Description	Info	Default DMX Value	Fader Type		
1	Shutter	0	7	0,0%	2,7%	Closed	10 (3,9%)	Snap	
		8	15	3,1%	5,9%	Open			
		16	151	6,3%	59,2%	Strobe			Slow > Fast
		152	175	59,6%	68,6%	Pulse - Open			Slow > Fast
		176	199	69,0%	78,0%	Pulse - Close			Slow > Fast
		200	244	78,4%	95,7%	Strobe - Random			Slow > Fast
		245	255	96,1%	100,0%	Open			
2 3	Intensity	0	65535	0,0%	100,0%	No light > Maximum light	0 (0%)		
4 5	Red	0	65535	0,0%	100,0%	No RED > Maximum RED	0 (0%)		

30 Channel Mode (Extended)

Channel	Name	DMX Value	DMX Percentage	Description	Info	Default DMX Value	Fader Type
6 7	Green	0 65535	0,0% 100,0%	No GREEN > Maximum GREEN		0 (0%)	
8 9	Blue	0 65535	0,0% 100,0%	No BLUE > Maximum BLUE		0 (0%)	
10	CTC	0 4	0,0% 1,6%	No CTC		0(0%)	Fade
		5 5	2,0% 2,0%	≈ 2000K			
		15 15	5,9% 5,9%	≈ 2200K (High Pressure Sodium Lamp)			
		40 40	15,7% 15,7%	≈ 2700K (Incandescent Lamp)			
		54 54	21,2% 21,2%	≈ 3000K (Halogen / Tungsten lamp)			

30 Channel Mode (Extended)

Channel	Name	DMX Value	DMX Percentage	Description	Info	Default DMX Value	Fader Type	
10	CTC	65	65	25,5%	25,5%	≈ 3200K (Warm Metal Halide Lamp)	0(0%)	Fade
		105	105	41,2%	41,2%	≈ 4000K (Clear Metal Halide Lamp)		
		115	115	45,1%	45,1%	≈ 4200K (Cool White Fluorescent Lamp)		
		177	177	69,4%	69,4%	≈ 5500K (Daylight Metal Halide Lamp)		
		216	216	84,7%	84,7%	≈ 6300K		
		238	238	93,3%	93,3%	≈ 8000K		
		255	255	100,0%	100,0%	≈ 10,000K		

30 Channel Mode (Extended)

Channel	Name	DMX Value		DMX Percentage		Description	Info	Default DMX Value	Fader Type
11 12	Pan	0	65535	0,0%	100,0%	-270° to 270°	-270° = Front Lens @ Mains Power Input (Tilt=0)	32767 (50%)	Pan
13 14	Tilt	0	65535	0,0%	100,0%	-120° to 120°	-120° = Front Lens @ Base Front (Pan=32767)	32767 (50%)	Fade
15	Gobo Wheel 1 (closest to light source)	0	20	0,0%	7,8%	Open		0 (%)	Snap
		21	41	8,2%	16,1%	Gobo 1 - Position 1			
		42	62	16,5%	24,3%	Gobo 1 - Position 2			
		63	83	24,7%	32,5%	Gobo 1 - Position 3			
		84	104	32,9%	40,8%	Gobo 1 - Position 4			
		105	127	41,2%	49,8%	Gobo 1 - Position 5			

30 Channel Mode (Extended)

Channel	Name	DMX Value	DMX Percentage	Description	Info	Default DMX Value	Fader Type	
15	Gobo Wheel 1 (closest to light source)	128	191	50,2% 74,9%	Gobo Wheel Continuous Rotation CW	Fast > Slow	0 (%)	Snap
		192	192	75,3% 75,3%	No Rotation			
		193	255	75,7% 100,0%	Gobo Wheel Continuous Rotation CCW			
16 17	Gobo Wheel 1 Indexing Rotation Shake	0	32767	0,0% 50,0%	Gobo Index		0 (0%)	Fade
		32768	32799	50,0% 50,0%	No Effect			
		32800	46418	50,0% 70,8%	Gobo Continuous Rotation CW	Fast > Slow		
		46419	46919	70,8% 71,6%	No Rotation			
		46920	60538	71,6% 92,4%	Gobo Continuous Rotation CCW	Slow > Fast		

30 Channel Mode (Extended)

Channel	Name	DMX Value		DMX Percentage		Description	Info	Default DMX Value	Fader Type
16 17	Gobo Wheel 1 Indexing Rotation Shake	60539	65535	71,6%	92,4%	Gobo Shake	Slow > Fast	0 (0%)	Fade
18	Gobo Wheel 2 (closest to front lens)	0	20	0,0%	7,8%	Open		0 (%)	Snap
		21	41	8,2%	16,1%	Gobo 2 - Position 1			
		42	62	16,5%	24,3%	Gobo 2 - Position 2			
		63	83	24,7%	32,5%	Gobo 2 - Position 3			
		84	104	32,9%	40,8%	Gobo 2 - Position 4			
		105	127	41,2%	49,8%	Gobo 2 - Position 5			
		128	191	50,2%	74,9%	Gobo Wheel Continuous Rotation CW	Fast > Slow		

30 Channel Mode (Extended)

Channel	Name	DMX Value		DMX Percentage		Description	Info	Default DMX Value	Fader Type
18	Gobo Wheel 2 (closest to front lens)	192	192	75,3%	75,3%	No Rotation		0 (%)	Snap
		193	255	75,7%	100,0%	Gobo Wheel Continuous Rotation CCW	Slow > Fast		
19 20	Gobo Wheel 2 Indexing Rotation Shake	0	32767	0,0%	50,0%	Gobo Index		0 (0%)	Fade
		32768	32799	50,0%	50,0%	No Effect			
		32800	46418	50,0%	70,8%	Gobo Continuous Rotation CW	Fast > Slow		
		46419	46919	70,8%	71,6%	No Rotation			
		46920	60538	71,6%	92,4%	Gobo Continuous Rotation CCW	Slow > Fast		
		60539	65535	71,6%	92,4%	Gobo Shake	Slow > Fast		

30 Channel Mode (Extended)

Channel	Name	DMX Value	DMX Percentage	Description	Info	Default DMX Value	Fader Type	
21	Iris	0	200	0,0%	78,4%	Open > Close	0 (0%)	Fade
		201	205	78,8%	80,4%	Effect - "Open fast / Close slow"		
		206	210	80,8%	82,4%	Effect - "Open slow / Close fast"		
		211	215	82,7%	84,3%	Effect - "Open / Close"		
		216	255	84,7%	100,0%	Effect - "Random Close / Open"		
22	Effect Wheel	0	4	0,0%	1,6%	Open	0 (0%)	Fade
		5	127	2,0%	49,8%	Indexed		
		128	153	50,2%	60,0%	Continuous rotation CW		

30 Channel Mode (Extended)

Channel	Name	DMX Value	DMX Percentage	Description	Info	Default DMX Value	Fader Type		
22	Effect Wheel	154	179	60,4%	70,2%	Continuous rotation CCW	Slow > Fast	0 (0%)	Fade
		180	255	70,6%	100,0%	Calibrated position			
26	Prism	0	4	0,0%	1,6%	Open		0 (0%)	
		5	129	2,0%	50,6%	Continuous Rotation CW	Fast > Slow		
		130	130	51,0%	51,0%	No Rotation			
		131	255	51,4%	100,0%	Continuous Rotation CCW	Slow > Fast		
27	Frost	0	5	0,0%	2,0%	Open		0 (0%)	Fade
		6	255	2,4%	100,0%	No Frost > Maximum Frost			
28	Zoom	0	255	0,0%	100,0%	Wide > Narrow		0 (0%)	Fade

30 Channel Mode (Extended)

Channel	Name	DMX Value	DMX Percentage	Description	Info	Default DMX Value	Fader Type	
29	Effect Channel	0	4	0,0%	1,6%	No Effect	0 (0%)	Snap
		5	15	2,0%	5,9%	Reserved (No Effect)		
		16	26	6,3%	10,2%	Reserved (No Effect)		
		27	32	10,6%	12,5%	Shutter Black = RED		
		33	38	12,9%	14,9%	Shutter Black = GREEN		
		39	44	15,3%	17,3%	Shutter Black = BLUE		
		45	50	17,6%	19,6%	Shutter Black = WHITE		
		51	56	20,0%	22,0%	Shutter Black = Magenta		
		57	62	22,4%	24,3%	Shutter Black = Yellow		
		63	68	24,7%	26,7%	Shutter Black = Cyan		

30 Channel Mode (Extended)

Channel	Name	DMX Value	DMX Percentage	Description	Info	Default DMX Value	Fader Type
29	Effect Channel	69 255	27,1% 100,0%	Reserved (No Effect)		0 (0%)	Snap
30	Control Channel	0 4	0,0% 1,6%	No Function		0 (0%)	Snap
		5 9	2,0% 3,5%	Full Reset	Hold 3 seconds		
		10 14	3,9% 5,5%	Pan Reset	Hold 3 seconds		
		15 19	5,9% 7,5%	Tilt Reset	Hold 3 seconds		
		20 24	7,8% 9,4%	Gobo Reset	Hold 3 seconds		
		25 29	9,8% 11,4%	Zoom Reset	Hold 3 seconds		

30 Channel Mode (Extended)

Channel	Name	DMX Value		DMX Percentage		Description	Info	Default DMX Value	Fader Type
30	Control Channel	30	34	11,8%	13,3%	Sleep Mode	See note ¹	0 (0%)	Snap
		35	39	13,7%	15,3%	Display Off	Hold 3 seconds		
		40	44	15,7%	17,3%	Display On	Hold 3 seconds		
		45	255	17,6%	100,0%	Reserved (No Function)			

1. All other channels must be zero and this has to be held for 30 sec. (fixture will wake up on a full reset).

Full Color Calibration and Color Temperature Correction

24 and 30 Channel Mode: Features full color calibration when you mix 2 or 3 colors to ensure uniform color between products. Adjusting 1 color does not activate full color calibration.

24 and 30 Channel Mode: Features full color temperature correction when channel 6 (in 24 channel mode) or channel 10 (in 30 channel mode) are at DMX value 5 or higher. When the value is below 5, the fixture runs in RAW mode.

Effects

Two independent rotating gobo wheels

The two independent rotating gobo wheels has five slots plus one open position on each to control the shape of emitted light. Each gobo is indexable with bi-directional rotation. The standard gobo set includes both breakup patterns, geometric gobos and full colored gobos.

Effect wheels

The G-Spot has two effect wheels for generating optical effect. The two effect wheels operate as an extension to one another for achieving continuous animation effect.

High-precision pan and tilt

The G-Spot has a 16-bit pan and tilt control, with a 540° pan and 270° tilt movement with feedback.

Ultra high-speed strobe effect

The ultra high-speed strobe effect (1-50 Hz) introduces instant color control and the possibility to strobe between two or more colors at any speed. Random strobe and pulse effects can be generated with variable speed.

Prism

4-facet rotating prism.

Frost

The soft high-quality frost filter is variable from 0% to 100%.

Fixtures and accessories

Included items

Two Omega brackets with 1/4-turn fasteners
2 m power cable with Neutrik TRUE1 power connector
User manual

Ordering information

G-Spot Moving Head in cardboard box	Order no: 80021002
G-Spot Moving Head in flight case (1 fixture).....	Order no: 80021004
SGM USB uploader cable	Order no: 83062011
2 m power cable with Neutrik TRUE1 power connector	Order no: 07860040
Flight case (1 fixture).....	Order no: 82051001

APPROVALS AND CERTIFICATIONS

Conforms to	2004/108/EC: EMC Directive
Conforms to	2006/95/EC: Low Voltage Directive
Conforms to	2011/65/EU: RoHS2 Directive
Conforms to	UL Std.1573
Certified to	CSA E60598-1:02, Ed: 2
Certified to	CSA-E598-2-17-98, Ed: 1



The information in this document is subject to change without notice

User's notes



SGM A/S · Sommervej 23 · 8210 Aarhus V · Denmark
Tel +45 70 20 74 00 · info@sgmlight.com · www.sgmlight.com